

CP 150 spirometry option

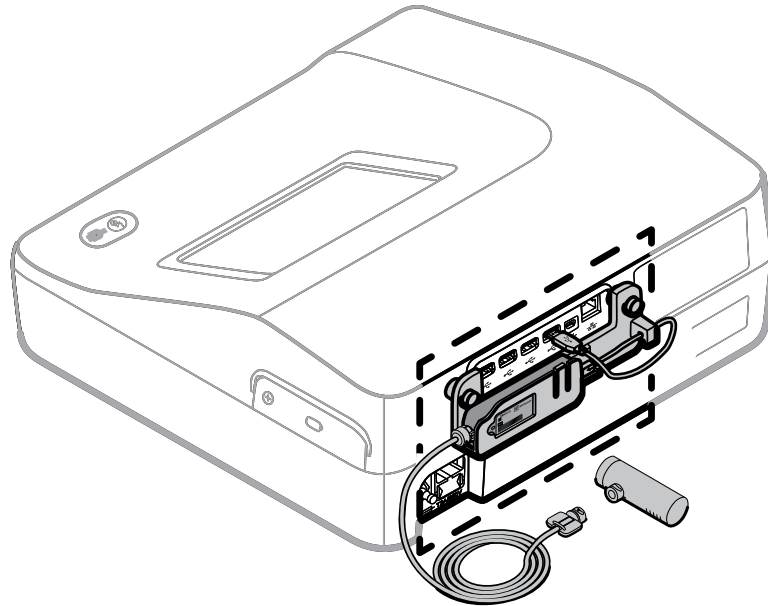

Directions for use

Software version 2.10.XX

WelchAllyn[®]

Advancing Frontline Care[™]

© 2018 Welch Allyn, Inc. All rights are reserved. To support the intended use of the product described in this publication, the purchaser of the product is permitted to copy this publication, for internal distribution only, from the media provided by Welch Allyn. No other use, reproduction, or distribution of this publication, or any part of it, is permitted without written permission from Welch Allyn. Welch Allyn assumes no responsibility for any injury, or for any illegal or improper use of the product, that may result from failure to use this product in accordance with the instructions, cautions, warnings, or indications for use published in this manual.

Welch Allyn is a registered trademark of Welch Allyn, Inc. CP 150, and CardioPerfect are trademarks of Welch Allyn, Inc.

Patent information

For patent information, please visit www.welchallyn.com/patents.

Software in this product is copyright Welch Allyn or its vendors. All rights are reserved. The software is protected by United States of America copyright laws and international treaty provisions applicable worldwide. Under such laws, the licensee is entitled to use the copy of the software incorporated within this instrument as intended in the operation of the product in which it is embedded. The software may not be copied, decompiled, reverse-engineered, disassembled or otherwise reduced to human-perceivable form. This is not a sale of the software or any copy of the software; all right, title and ownership of the software remains with Welch Allyn or its vendors.

For information about any Welch Allyn product, contact Welch Allyn Technical Support: <http://www.welchallyn.com/support>.

106584 (CD)
DIR 80023838 Ver. A
Revision date: 2018-07

This manual applies to the REF 901049 ELECTROCARDIOGRAPH
and the REF 901051 SPIROMETER



Welch Allyn, Inc.
4341 State Street Road
Skaneateles Falls, NY 13153 U.S.A.
www.welchallyn.com

EC REP

Regulatory Affairs Representative
Welch Allyn Limited
Navan Business Park
Dublin Road
Navan, County Meath
Republic of Ireland

CE
0297

WelchAllyn[®]
Advancing Frontline Care[™]

Contents

Introduction	1
About this document	1
Intended use	1
Indications for use	2
Contraindications	2
Description	2
Features	2
Configuration options for CP150 electrocardiograph with spirometry option	3
Controls, indicators, and connectors	4
Symbols	7
General warnings	10
General cautions	11
Setup	13
Connect the spirometer	13
Settings	17
View or change the spirometry settings	17
Spirometry home screen	19
Spirometry home screen	19
About calibration	23
Perform a calibration	23
Calibrate multiple flows	26
Prepare the patient	29
Spirometry tests	31
Overview of the testing process	31
Perform a new Forced Vital Capacity spirometry test	32
Continue saved test	36
Perform a spirometry post test	38
Work with a Saved test	39
Troubleshooting	41
Symptoms and solutions	41
Maintenance	43
Cleaning the spirometer, calibration syringe, and patient handle	43
Storing the equipment	44

Disposing of electronic equipment	44
General compliance and standards	45
General radio compliance	45
Federal Communications Commission (FCC)	45
Industry Canada (IC) emissions	46
EMC guidance and manufacturer's declarations	47
Specifications	53
Limited warranty	57
Service policy	59
Spirometry protocols	61
About the PCP protocol	61
About the NIOSH protocol	61
About the patient help sheets	63
Adult smokers help sheet	64
Asthma symptoms help sheet	65
Predictive Norms and interpretation	67
About Norm extrapolation	67
About race adjustment	67
About composite Norm values	68
About lung age	68
List of Norm-related clinical studies	70
About quality feedback	72
Understanding your interpretation results	73
References	74
Glossary	75
Appendix	81
Approved accessories	81

Introduction

About this document

This manual is written for clinical professionals performing pulmonary function testing. Users must be familiar with measurements and the clinical significance of basic spirometry products.

Before using the spirometer, all users and technicians must read and understand this manual and all other information accompanying the CP 150 spirometry option and the CP 150 electrocardiograph.

Caregivers need to know how to properly coach patients, to recognize acceptable waveforms, and to know whether results meet ATS reproducibility criteria.

The hospital's Biomedical/IT support staff shall require primary skills including disciplines related to maintenance and servicing computer controls/platforms.

It is recommended that users attend a certified spirometry training course. The instructions given here are only a guide and should not be used to train a technician.

Note This manual supplements the CP 150 electrocardiograph manual, entitled *CP 150 12-lead resting electrocardiograph Directions for use*.

See the electrocardiograph manual for procedures that are common to both ECG and spirometry functions, such as how to move through the menus or how to search for patient data.

Intended use

The CP 150 spirometry option allows the user to acquire, view, store, and print measures and waveforms of pulmonary function including, but not limited to, maximal volume and flow of air that can be moved in and out of a patient's lungs. These measures are used in the diagnosis and monitoring of lung diseases and interventions for the treatment of certain lung diseases.

The spirometer should only be used with patients who are able to understand the instructions for performing the test.

Indications for use

The spirometer is a device that measures lung air volume and airflow rate for pulmonary disease diagnosis and screening. These measurements provide information about a patient's pulmonary function which may be compared with normal values or the patient's previous values.

The device is designed to test pulmonary function and obtain spirometric indices for

- adult and pediatric patients 12 years and older,
- hospital and clinic use only.

Contraindications

Relative contraindications to performing spirometry:

- hemoptysis of unknown origin (forced expiratory maneuver may aggravate the underlying condition)
- pneumothorax
- unstable cardiovascular status (forced expiratory maneuver may worsen angina or cause changes in blood pressure) or recent myocardial infarction or pulmonary embolus
- thoracic, abdominal, or cerebral aneurysms (danger of rupture due to increased thoracic pressure)
- presence of an acute disease process that might interfere with test performance (e.g., nausea, vomiting)
- recent eye (for example, cataract), thoracic and abdominal surgery
- chest and abdominal pain

Description

- The CP150 is a 12-lead diagnostic ECG device with a spirometry function.
- The CP150 spirometry option provides the ability to print test records on an internal printer.
- The CP150 spirometry option allows storage of test records in device memory, external storage media, and external software applications.

Features

- Automatic interpretation and comparison of best pre-bronchodilator effort to best post-bronchodilator effort
- Real-time flow/volume and volume/time graphs on full-color LCD display
- Incentive graphics for patient coaching
- Multiple predictive norms, including NHANES III
- Reduced risk of cross-contamination with Welch Allyn single-use, disposable flow transducers
- Patient education help sheets
- Instant quality and variability checks for proper test performance
- Customizable report formats

- Meets ATS/ERS 2005 spirometry standards
- Single-flow and multiple-flow calibration protocols
- NIOSH protocols to create reports that meet agency requirements
- PCP (primary care practitioner) protocol that follows NLHEP guidelines
- Meets industry standards, including ATS and NIOSH
- Transfer results into the CardioPerfect workstation for easy analysis, reviewing, storing, printing, and exporting
- Compliant with the National Lung Health Education Program (NLHEP) guidelines for office spirometers. For more information about NLHEP criteria, visit <http://www.nlhep.org/spirometer-review-process.html>.

Configuration options for CP150 electrocardiograph with spirometry option

Model	Accessories	Language	Power cord
CP150	1 - AHA, disposable	EN - English	B - North America
	A - Interpretation	2 - IEC, disposable	
	S - Spirometry	3 - AHA, reusable	
	W - WiFi	4 - IEC, reusable	

Note The spirometry option is only available in English.

Examples: CP150W-1ENB, CP150S-1ENB, and CP150AS-1ENB

Controls, indicators, and connectors

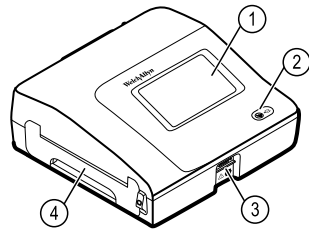

No.	Feature	Description
1	LCD screen	800 x 480 pixels color touchscreen provides a graphical user interface.
2	Power switch and LED	Power-on/Standby switch. The LED indicates the charging status when connected to AC power: <ul style="list-style-type: none"> • Green: The battery is charged. • Amber: The battery is charging.
3	Patient cable connector	Provides connection for patient cable.
4	Printer	Spirometry FVC report Efforts: <ul style="list-style-type: none"> • All efforts: Prints all efforts. • Three best efforts: Prints the three best efforts of each type that was saved. • Only the best effort: Prints only the best effort of each type that was saved — best FVC, FVC-pre, FVC-post. <p>Note The printer also provides a printout of patient Auto ECG, Stat ECG, or Rhythm ECG.</p>

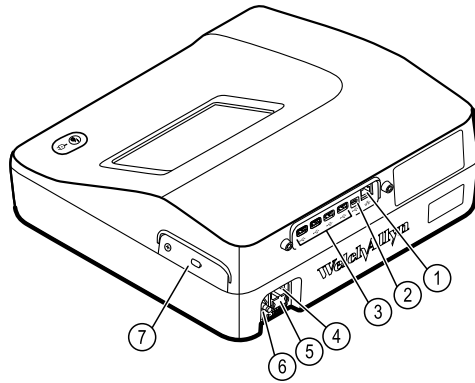

Back view



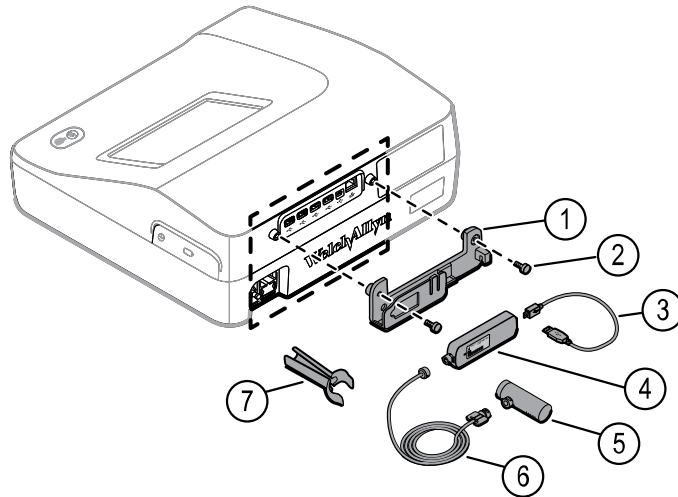



No.	Feature	Description
1	Ethernet connector	Provides a hardwired connection to the computer network. The LEDs indicate active network status when the ethernet cable is connected to a network.
2	Clients USB	USB, type "mini B." Provides connection to an enabled host.
3	Host USB	USB, type "A." Provides four host USB connections for optional accessories.
4	Power connection	Provides an external AC power connection.
5	AC fuse	Provides access to AC fuse.
6	Ground lug (equipotential terminal)	Provided for electrical safety testing and as a means for connection of a potential equalization conductor.
7	Battery compartment (behind cover)	Houses the Li-ion battery.

Spirometry option back view















No.	Feature	Description
1	Bracket	Spirometer sensor mounting bracket
2	Thumb screws	Thumb screws to attach bracket to device
3	USB cable	Provides spirometer sensor connection to device
4	Spirometer sensor	USB spirometer sensor
5	Disposable flow transducers	Measures patient air velocity. Connects to pressure tubing.
6	Pressure tubing	Connects flow transducer to USB spirometer sensor
7	Patient handle	Holds flow transducer and pressure tubing

Symbols

Documentation symbols



	<p>WARNING The warning statements in this manual identify conditions or practices that could lead to illness, injury, or death.</p>		<p>Caution The caution statements in this manual identify conditions or practices that could result in damage to the equipment or other property, or loss of data. This definition applies to both yellow and black and white symbols.</p>
	<p>Consult directions for use (DFU). A copy of the DFU is available on this website. A printed copy of the DFU can be ordered from Welch Allyn for delivery within 7 calendar days.</p>	  	<p>Meets essential requirements of the European Medical Device Directive 93/42/EC</p>

Power symbols



	<p>Power on/standby</p>		<p>Battery</p>
	<p>Alternating Current power present, battery fully charged</p>		<p>Battery absent or faulty</p>
	<p>Alternating Current power present, battery is charging</p>		<p>Battery charge level</p>
	<p>Alternating current (AC)</p>		<p>Battery Charging - AC powered</p>
	<p>Dangerous voltage</p>		<p>Power plug</p>
	<p>Fuse</p>	 <p>Li-ion</p>	<p>Rechargeable battery</p>
	<p>Protective Earth (PE)</p>		<p>Rated power input, AC</p>

	Equipotential Ground
---	----------------------









Connectivity symbols





	USB		Ethernet
---	-----	---	----------

Wireless radio symbols







	<p>Wireless signal strength</p> <ul style="list-style-type: none"> • Best (4 bars) • Good (3 bars) • Fair (2 bars) • Weak (1 bar) • No connection (no bars) 		Non-ionizing electromagnetic radiation
FCC ID	The identification number assigned by the Federal Communications Commission SQG-WB45NBT	IC ID	Industry Canada identification number. The equivalent governing body to the FCC in the United States 3147A-WB45NBT
	Australian Communications and Media Authority (ACMA) Radio Compliance Mark (RCM)		

Shipping, storing, and environment symbols

	This way up		Keep Dry
	Fragile		Humidity limitation
	Temperature limit		Atmospheric pressure limitation
	Separate collection of batteries. Do not dispose as unsorted municipal waste.		Recyclable

	Separate collection of Electrical and Electronic Equipment. Do not dispose as unsorted municipal waste.		China RoHS
Li-ion	Lithium ion battery		Keep away from sunlight
	Use by Date	IP20	Protected against the ingress of solid foreign objects ≥ 12.5 mm diameter, not protected against the ingress of water.

Miscellaneous symbols

	Manufacturer		Defibrillation-proof Type CF applied part
REF	Product Identifier	SN	Serial Number
#	Reorder Number	LOT	Lot Code
R_x ONLY	Prescription only or "For Use by or on the order of a licensed medical professional"		Do not re-use, Single use device
EC REP	Authorized Representative in the European Community	GTIN	Global Trade Item Number
	Call for maintenance		Clock; time switch; timer
	Type BF applied part		

General warnings

The following warning statements apply to spirometer use in general. Warning statements that apply specifically to particular procedures, such as preparing the patient for testing, appear in the corresponding sections of the manual.

Warnings indicate conditions or practices that could lead to illness, injury, or death.



WARNING The spirometer captures and presents data reflecting a patient's physiological condition. When reviewed by a trained physician or clinician, this data can be useful in determining a diagnosis. However, the data should not be used as a sole means for determining a patient's diagnosis.



WARNING To minimize the chance of a misdiagnosis, it is the physician's responsibility to assure that spirometry tests are properly administered, evaluated, and interpreted.



WARNING To prevent the spread of infection, do not try to clean the flow transducers and nose clips. Discard these items after a single patient use.



WARNING Keep the reusable patient handle clean. Patient contact with contaminated equipment can spread infection.



WARNING Read and observe all safety information provided in the flow transducer instructions.



WARNING Use only parts and accessories supplied with the device and available through Welch Allyn. The use of accessories other than those specified may result in degraded performance of this device.

General cautions

The following caution statements apply to spirometer use in general. Caution statements that apply specifically to particular procedures appear in the corresponding sections of the manual.

Cautions indicate conditions or practices that could damage the equipment or other property, or loss of data.



CAUTION Do not clean the spirometer or any of its components. Trapped moisture in the pressure tubing or sensor could affect their accuracy. Replace the pressure tubing when it becomes dirty. Replace the sensor when it becomes faulty. Recalibrate the spirometer after replacing any components.



CAUTION Do not immerse any part of the spirometer into a cleaning liquid or sterilize it with hot water, steam, or air.



CAUTION Do not use aromatic hydrocarbons, rubbing alcohol, or solvents on the spirometer.



CAUTION If you choose to clean the calibration syringe, wipe the outer surface of the calibration syringe with a clean cloth slightly dampened with 70 percent isopropyl alcohol.



CAUTION When you put the spirometer away, store its pressure tubing carefully to prevent pinching, compression, or kinking.



CAUTION Avoid installing the spirometer in direct sunlight or in a location where it may be affected by significant changes in humidity, ventilation, or airborne particles containing dust, salt, or sulfur.



CAUTION Keep the spirometer away from splashing fluids.

Setup

Connect the spirometer



WARNING To prevent the spread of infection, use a new flow transducer for each patient. Use protective gloves when replacing used flow transducers, and wash hands after touching them. Discard flow transducers after a single patient use.

Connect the spirometer components

1. Attach the right side of the spirometer mounting bracket to the device using one of the thumb screws. Tighten the thumbscrew.

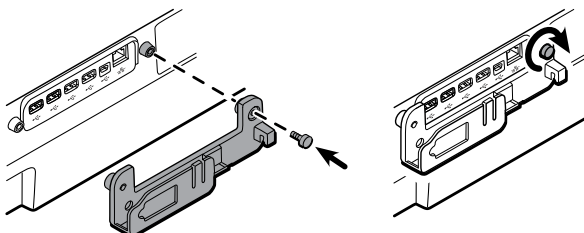

2. Insert the spirometer sensor into the mounting bracket.

Ensure that the spirometer sensor label is visible in the mounting bracket window so that the mini USB cable connector installs correctly during the next steps.

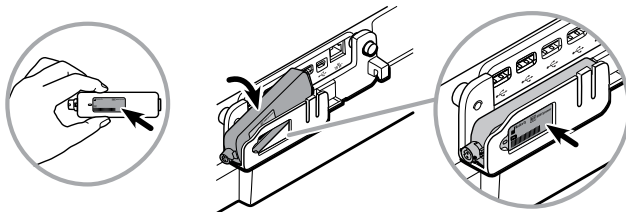

3. Attach the left side of the spirometer mounting bracket to the device using the second thumb screw. Tighten the thumbscrew.

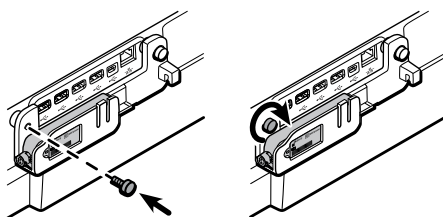

4. Insert the mini USB cable connector into the spirometer sensor mini USB port.
 - a. Insert the USB cable into the spirometer sensor mounting bracket groove to secure the cable.
 - b. Insert the USB cable connector into the device's first USB port, furthest to the right.

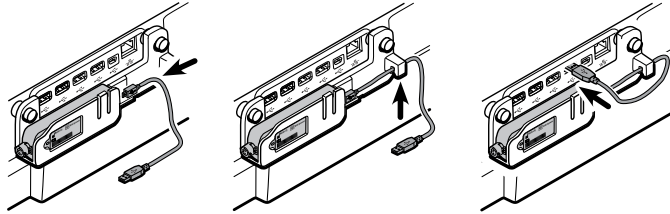

Note The mounting bracket is designed to protect the spirometer sensor and USB cable and only accepts the USB cable mini connector when the spirometer sensor label faces outward.

5. Verify that the spirometer sensor and pressure tubing are clean and undamaged. Look for signs of deterioration, including but not limited to cracks, cuts, discoloration, or oxidation. If any part exhibits any of these symptoms, replace it.
 - a. Attach the pressure tubing to the spirometer sensor.
 - b. Attach a flow transducer to the pressure tubing.

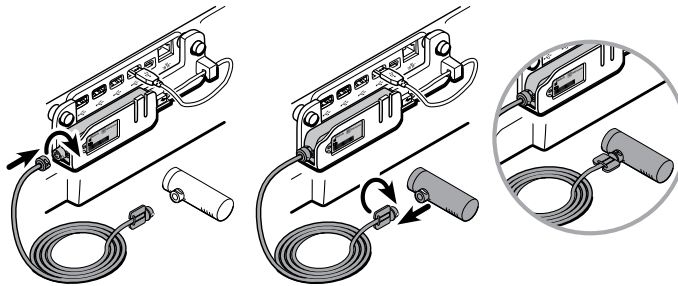

CAUTION Hand-tighten the spirometer sensor and flow transducer connectors to avoid damaging the connectors.

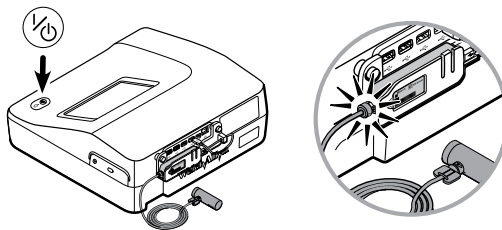

The CP 150 software automatically activates the spirometry functions throughout the software. Once the software recognizes the sensor, the *Spirometry* button appears in the Content area.

6. Push the flow transducer down onto the patient handle until it is secure.

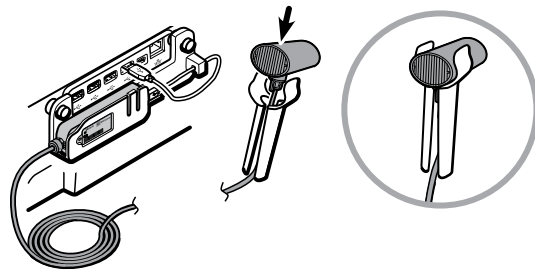

WARNING Keep the reusable patient handle clean. Patient contact with contaminated equipment can spread infection.

Note

Clean the patient handle after each patient use.

Settings

View or change the spirometry settings

- The spirometry settings control the predictive norms, parameters, formulas, and content of your report.

To view or change the settings

1. Touch the **Settings** tab. The ECG tab and the vertical ECG configuration tab appear.
2. Touch the **Spirometry** tab. The vertical Spirometry configuration tab appears.

Modify the settings as desired:

Note The following settings are saved as they are selected.

- Protocol
- Predictive norm
- Incentive options
- Best effort formula
- FVC reversibility formula

Touch  (Next).

Modify the settings as desired:

- FEV1% formula
- Temperature unit
- Pressure unit
- Flow unit
- Enable ATS interpretation
- Composite norm values

Touch the **FVC report** tab.

Modify the settings as desired:

- Efforts
- Lung age
- Quality grades
- Print "ATS Reproducibility Not Met"

Touch  (Next).

Modify the settings as desired:

- First name
- Smoke Years
- Packs/day
- Age or Birth date
- Middle initial
- Weight
- Comments

Touch the **Parameters** tab.

Modify the settings as desired:

Note Select up to eight parameters to display and print.

Touch  (Next) to view additional parameters.

Touch the **Spirometry calibration** tab.

Modify the settings as desired:

- Touch **Calibrate single flow**.
- Touch **Calibrate multiple flows**.
- Touch **Print report**.
- Enable daily reminder

Spirometry home screen

Spirometry home screen

The Spirometry home screen includes the following areas:

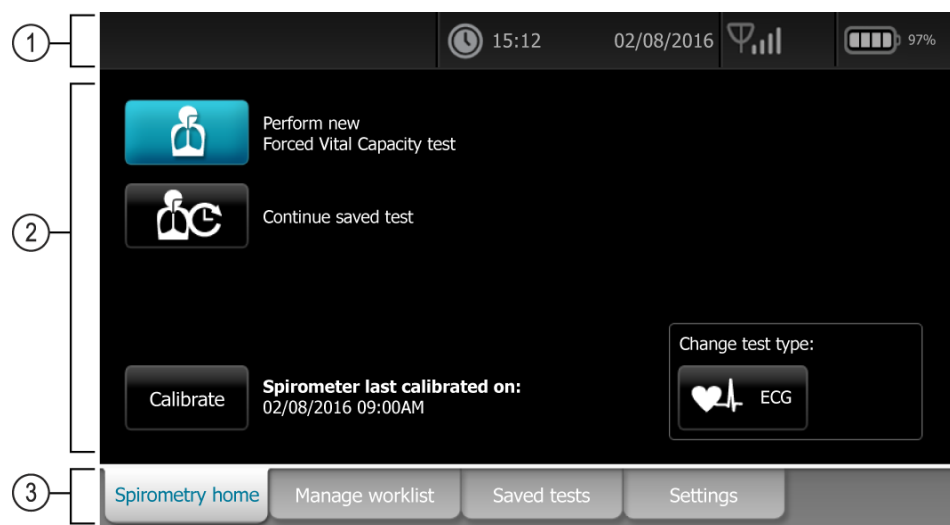

Item	Area
1	Device status
2	Content
3	Navigation

Device status area

The Device status area, located at the top of the Spirometry home screen, displays:

- Patient Icon and Patient name. Once the patient context is established, the format of the Patient name appears as last name, first name.
- Time and date
- Connectivity status. The icons indicate which connection type, if any, is currently active.

- Battery status
- Error or information messages. These items are displayed until the condition has been resolved.

Content area

The Content area includes 2 test selection buttons, a calibrate button, and a button to change the test type:

- **Perform new Forced Vital Capacity test**
- **Continue saved test**
- **Calibrate**
- **Change test type**

The content area also provides shortcuts to several controls.

About the test types

FVC



Perform new Forced Vital Capacity test

"FVC" stands for forced vital capacity. "FVC" is a type of test in which the patient inhales fully and exhales forcefully for as long as they can. The goal of a "FVC" effort is to measure the volume and flow of air. The "FVC" test may or may not include forced inhaling. When forced inhaling is included, it may be done either before or after exhaling.

Continue saved test



A test that provides data to compare with pre-test data. Sometimes called post-Rx or post-BD (bronchodilator). A post-test must follow a pre-test within 24 hours.

ECG



Change test type:

Auto ECG

- A report typically showing a 10-second acquisition of 12 leads of ECG information combined with patient data, measurements, and optional interpretation. Auto ECGs can be saved to the electrocardiograph's test directory or to a USB mass-storage device.

Rhythm ECG

- A continuous, real-time printout of rhythm strips with a user-defined lead configuration. Rhythm ECGs are printouts only. They cannot be saved.

Stat ECG

- An auto ECG that starts without waiting for you to enter patient data. Patient data does not appear.

Navigation area

The Navigation area includes the following tabs:

- **Spirometry home:** Displays spirometry test types and provides shortcuts to several controls.
- **Manage worklist:** Includes patient data entered manually or orders downloaded when connected to a hospital information system.
- **Saved tests:** Accesses the patient spirometry and ECG tests.
- **Settings:** Accesses device configuration settings.

To navigate to a tab, touch the tab in the Navigation area with the corresponding name. The active tab is highlighted.

Example spirometry report

Spirometry Report - JOHN DOE
9/27/2013
1 / 1

Patient Information:
 ID: 678901
 Name: JOHN DOE
 DOB: 6/5/1948 (65 yr)
 Height: 6'1"
 Gender: Male
 Race: Caucasian

Test Information:
 Test Type: FVC
 Time: 01:28 PM
 Post Time: 01:36 PM
 Values Selected: Best Measurement
 Norm Reference: NHANES III 1999
 Protocol: PCP
 BTPS (In/ex): 1.1/1.0
 Last Calibration: 9/23/2013
 Device Info: Welch Allyn
 2.00.01 E0003
 100001662813

Test Results:

Pre: FEV1 Variance 56 ml (0.1 L ¹)	FVC Variance 2 ml (0.0 L ¹)
Post: FEV1 Variance --	FVC Variance --
Improvement: 6% 2% FEV1 -4% FEV1	
FEV1: 104% Predicted	Lung age: 34 Years
FEV1% = 74 (FEV1/FEV6)	ATS Reproducibility Not Met

Quality Grades: F/F
 Quality Messages: 1 - Blow out longer; 2 - Blow out longer; 3 - Blow out longer; 4 - Blow out longer;
 results should be interpreted with caution

Unconfirmed Report

	Units	PRED	Best Pre #3	%Pred	Best Post #4	%Pred	%c
FEV1	L	3.8	3.9	102	4.0	104	--
FEV6	L	4.9	5.1	104	5.4	110	--
FEV1/FEV6	%	78	77	98	74	94	--

Flow: 2.7 mm/L/s Vol: 5.1 mm/L

Vol: 9.6 mm/L Time: 11.8 mm/s

Legend

- [] = Pre Effort
- [] = Post Effort
- [] = FVC
- [] = Variance after Rounding
- [*] = Below LLN
- [**] = Num too large

About calibration

The American Thoracic Society recommends calibrating a spirometer every day before testing. In addition, each time you open a new package of flow transducers, verify the lot number on the package label. If this lot number differs from the lot number used during the most recent calibration, you must recalibrate the spirometer using the new lot number before resuming testing.

There are two types of calibration:

Single-flow calibration

- One inhale/exhale cycle

Multiple-flow calibration

- Three inhale/exhale cycles at three different rates:
 - 3 L in 1 second (3 L/s)
 - 3 L in 3 seconds (1 L/s)
 - 3 L in 6 seconds (0.5 L/s)



CAUTION For proper performance, the calibration syringe must be recalibrated every year. See the syringe's calibration certificate for the most recent calibration date. When the syringe is due for recalibration, return it to the manufacturer.

Perform a calibration

Calibrate single flow

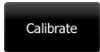

CAUTION To avoid the risk of cross-contamination, always use a new flow transducer when calibrating the spirometer. Observe all safety information that came with the flow transducers.

1. From the ECG Home screen touch  .
2. Touch  . The Spirometry calibration screen appears.
3. Touch **Calibrate single flow**.

Fill in these fields:

- Transducer lot code
- Transducer calibration code
- Syringe Vol. (in ml)

Spirometer calibration ✕

Transducer lot code <div style="border: 1px solid gray; padding: 2px; display: inline-block;">103</div>	Temperature (°F) <div style="border: 1px solid gray; padding: 2px; display: inline-block;">68</div>	Pressure (mmHg) <div style="border: 1px solid gray; padding: 2px; display: inline-block;">759.3</div>
Transducer calibration code <div style="border: 1px solid gray; padding: 2px; display: inline-block;">2MTCXV5D2</div>	Expired volume (ml) 3000.00	
Syringe vol (ml) <div style="border: 1px solid gray; padding: 2px; display: inline-block;">3000.00</div>	Humidity (%) <div style="border: 1px solid gray; padding: 2px; display: inline-block;">50</div>	Insired volume (ml) 3000.00
Last calibration 12/12/2013 08:00AM		

◀
▶

- Note** Obtain the transducer lot and calibration codes from the transducer package label.
- Note** For the syringe volume, see the sticker on the calibration syringe.
- Note** Humidity (%), Temperature, and Pressure are set through the USB spirometer sensor and are not editable fields. The temperature must be 10°– 40° C, 50°–104° F. The atmospheric pressure must be 600 –1100 mbar, 450 – 825 mmHg, 18 – 32 inHg, 60 – 110 kPa.

4. Touch ▶ (Next).
5. Pull the syringe plunger all the way out, as shown in the illustration.
6. Connect a new flow transducer to the pressure tubing.
7. Attach the flow transducer to the syringe's port, as shown in the illustration. Push the flow transducer all the way in for a tight seal.

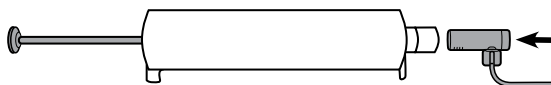

8. Touch **Continue**.



CAUTION Several things may affect calibration results: movement of the syringe, movement of the pressure tubing, or blockage of air. Place the syringe on a hard, level surface with at least 1 cubic meter of open air surrounding the flow transducer. Place your hand on top of the syringe to prevent movement.

9. Touch **Start** to begin the calibration.
10. When the black bar begins to move, push the plunger all the way in, then pull it all the way out, carefully following the black bar's rate. Use a steady motion in both directions.

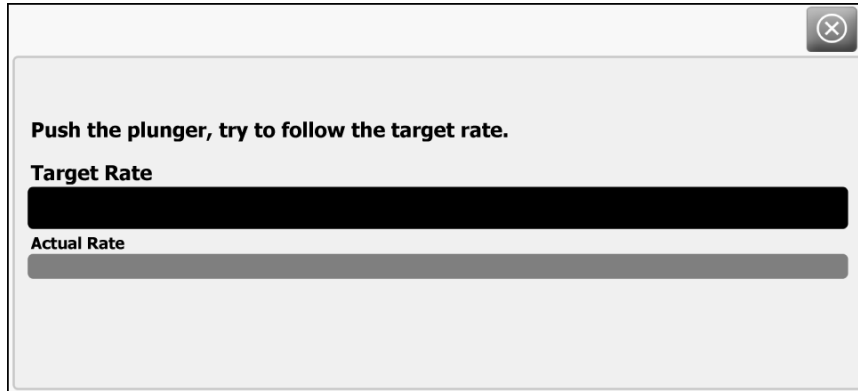

The results display for a single-flow calibration after no air has moved for three seconds.

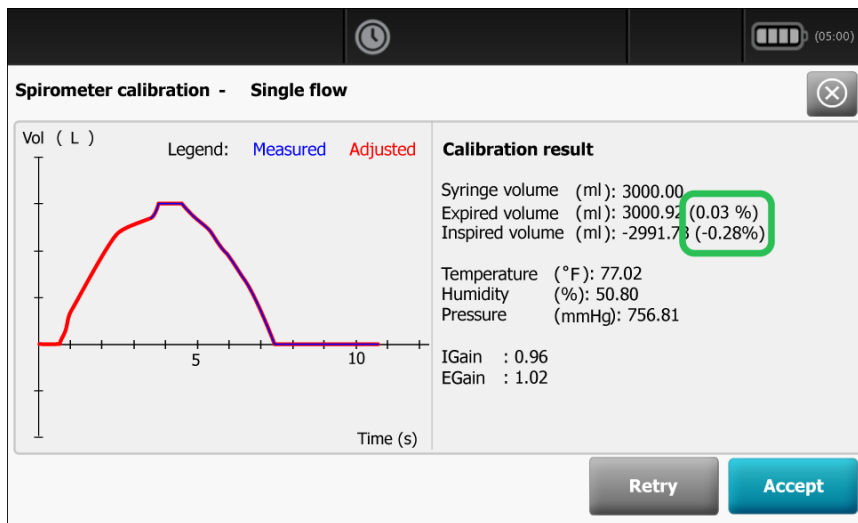



11. Review the results.

Note Check the error percentages for the expired and inspired volumes. Both volumes must be less than $\pm 3.5\%$ for the calibration to be acceptable. For single-flow calibrations, the measured and adjusted curves should match.

Note The syringe used to check the volume calibration of spirometers must have an accuracy of 15 mL for a 3-L syringe.

12. Touch **Accept** to save the calibration results.

Calibrate multiple flows



1. From the ECG home screen touch  .
2. Touch  . The Spirometry calibration screen appears.
3. Touch **Calibrate multiple flows**.

Fill in these fields:

- Transducer lot code
- Transducer calibration code
- Syringe Vol. (in ml)

Spirometer calibration ✕

Transducer lot code	Temperature (°F)	Pressure (mmHg)
<input type="text" value="103"/>	<input type="text" value="68"/>	<input type="text" value="759.3"/>
Transducer calibration code	Expired volume (ml)	
<input type="text" value="2MTCXV5D2"/>	3000.00	
Syringe vol (ml)	Humidity (%)	Insired volume (ml)
<input type="text" value="3000.00"/>	<input type="text" value="50"/>	3000.00
		Last calibration
		12/12/2013 08:00AM

- Note** Obtain the transducer lot and calibration codes from the transducer package label.
- Note** For the syringe volume, see the sticker on the calibration syringe.
- Note** Humidity (%), Temperature, and Pressure are set through the USB spirometer sensor and are not editable fields. The temperature must be 10°–40° C, 50°–104° F. The atmospheric pressure must be 600–1100 mbar, 450–825 mmHg, 18–32 inHg, 60–110 kPa.

4. Touch  (Next).
5. Pull the syringe plunger all the way out, as shown in the illustration.
6. Connect a new flow transducer to the pressure tubing.
7. Attach the flow transducer to the syringe's port, as shown in the illustration. Push the flow transducer all the way in for a tight seal.

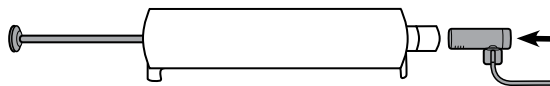

8. Touch **Continue**.



CAUTION Several things may affect calibration results: movement of the syringe, movement of the pressure tubing, or blockage of air. Place the syringe on a hard, level surface with at least 1 cubic meter of open air surrounding the flow transducer. Place your hand on top of the syringe to prevent movement.

9. Touch **Start** to begin the calibration.
10. When the black bar begins to move, push the plunger all the way in, then pull it all the way out, carefully following the bar's rate. Use a steady motion in both directions for 2 more times. Touch **Start** to begin each calibration.

When no air has moved for three seconds, the multiple flows results display.

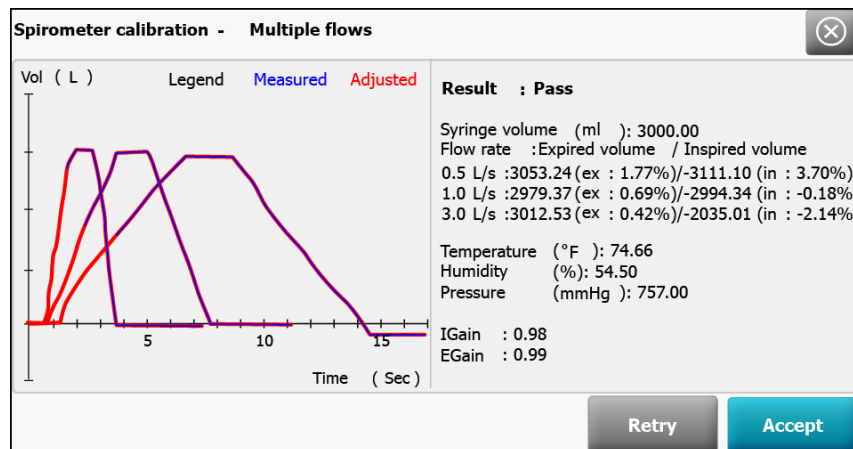

11. Review the results.

Note Check the error percentages for the expired and inspired volumes. The 0.5, 1.0, and 3.0 L/s expired and inspired volumes must be less than $\pm 3.5\%$ for the calibration to be acceptable.

Note The syringe used to check the volume calibration of spirometers must have an accuracy of 15 mL for a 3-L syringe.

12. Touch **Accept** to save the calibration results.

Prepare the patient

To prepare patients for any spirometry test, explain the entire procedure for the type of effort you want them to perform. Remind patients that the test should be painless. Demonstrate at least one effort for the patient. The accuracy of a spirometry test is highly dependent on the patient's understanding and cooperation. So, be prepared to coach and encourage the patient with your "body language" and your words — for example, "Blow, blow, blow, keep blowing until you can't blow any more out" — to ensure a good effort with reproducible results.

Instruct patients to do the following:

- Loosen any tight articles of clothing that might constrict lung function, for example, a tight belt, tie, vest, bra, girdle, or corset.
- Remove any foreign objects from the mouth, including loose dentures.

Note Use of a nose clip is optional. Patients may also pinch their nose to prevent air from escaping.

- Place your lips and teeth around a new transducer, sealing your lips tightly around the transducer. Grip slightly with your teeth in the groove. If you need to hold the flow transducer in your hand, keep fingers away from the screen on the back. Using the provided handle allows you to firmly hold the transducer and keep your fingers from blocking the screen and interfering with the transducer function. Blocking even part of this screen creates back-pressure, which makes the readings very high (as much as 200 or 300 percent), and the data will have to be discarded.
- Avoid bending forward as you blow.
- Keep your tongue away from the flow transducer to avoid blocking it.
- Keep your chin up so as not to restrict the airway.



WARNING Patients may become faint, light-headed, dizzy, or short of breath during spirometry testing. Watch patients closely. If they choose to stand during testing, keep a chair immediately behind them. If there is any reason for concern, stop the test and take proper action.



WARNING Patients should not bite on the flow transducer. Biting could result in sharp edges, which could injure the mouth.

Note The performance of the spirometer can be affected by the patient spitting or coughing into the spirometer during expiration or by extremes of temperature, humidity and altitude.

Spirometry tests

Overview of the testing process

A single test comprises a set of efforts that can be a mixture of pre- and post-medication efforts.

About FVC efforts

“FVC” stands for forced vital capacity. The goal of an FVC effort is to measure the volume and flow of air. Patients inhale fully then exhale forcefully. Sometimes they also inhale forcefully.

When ready to begin an FVC effort, you coach the patient through these steps. (If preferred, you may reverse the order of inhaling and exhaling.)

1. Inhale fully — calmly fill your lungs as much as you can.
2. Place the flow transducer in your mouth.
3. Exhale forcefully — as fast as you can, as long as you can.
4. (Optional) Inhale forcefully — as fast as you can, as long as you can.

During FVC testing, an optional animated incentive screen provides an alternative way to view the data. This screen gives patients a goal to achieve while exhaling. Touch the **Settings** tab. Touch the **Spirometry** tab. Select one of the animation *Incentive options* from drop down menu.

- Fireman
- Frog
- Dandelion
- Birthday

About the spirometry parameters

During FVC testing, many parameters are measured and calculated. For definitions of these parameters, see the Glossary.

During FVC testing, the two most important parameters in determining lung problems are FVC and FEV1. (For a description of how the automatic interpretation software uses these two measurements to determine the degree of obstruction or restriction, see *Understanding Your Interpretation Results* .

- FVC — forced vital capacity, the maximum volume of air that can be forcibly and rapidly exhaled

- FEV1 — forced expiratory volume 1, the volume of air that is exhaled at one second of a forced expiration

About pre- and post-testing

If desired, a spirometry test may include both pre- and post-efforts to measure the effectiveness of medication. The “before medication” and “after medication” efforts may be uninterrupted or interrupted.

- Uninterrupted — If there is no interruption between pre- and post-efforts (that is, no other patient has been tested and the device has remained on), the same screen continues to display. You simply continue with the procedure.
- Interrupted — If there is an interruption (that is, another patient has been tested or the device has been turned off), you need to recall the patient’s test-in-progress before continuing.

Note Pre- and post-efforts must happen on the same day. The next day tests become available for review only; you can no longer add efforts to them.

About effort replacement

You can save up to 6 FVC efforts per test. After saving 6 efforts of a given type, the software compares each new effort with the saved efforts. If the new effort is better than the worst saved effort, the worst effort is deleted and the new one is saved. If the new effort is worse than all saved efforts, you are asked whether you want to save it.

If 6 pre-efforts have been saved, the worst pre-effort is deleted when you add a post-effort until you have saved 3 pre- and 3 post-efforts. After that, the “worst” post-effort is deleted.

Perform a new Forced Vital Capacity spirometry test



CAUTION Patient data is not saved until the spirometry test is completed.

Note The spirometry configuration settings can be changed in the Settings tab. The following settings may appear differently if the default settings have been modified.

Note Set the Default patient entry tab to New patient in the Advanced settings.

1. From the ECG Home screen touch  .

Note If the *Daily Reminder* setting is enabled, the first time this button is pressed each day, the prompt “calibrate now?” appears.

2. Touch  (Perform new Forced Vital Capacity test). The New patient tab appears.
3. Enter the following patient information:

Note Required fields are denoted with an asterisk.

- Patient ID*. Touch **OK**.

- Birth date*. Touch **OK**.
 - Gender*. Touch **OK**.
 - Last name*. Touch **OK**.
 - First name. Touch **OK**.
 - Middle Initial. Touch **OK**.
4. Touch  (Next).
 5. Enter the following patient information:

Note Required fields are denoted with an asterisk.

 - Race*. Touch **OK**.
 - Height*. Touch **OK**.
 - Weight. Touch **OK**.
 - Smoke Years. Touch **OK**.
 - Packs/day. Touch **OK**.
 - Comments. Touch **OK**.
 6. Touch  (Next).
 7. Touch **View** or **Incentive** to select the display information that you want to view during the test.
 - a. **Modify the View settings as desired:**
 - View Flow/Volume. (View FV curve)
 - View Volume/Time. (View VT curve)
 - View Flow/Volume and Volume/Time. (View FV & VT)
 - View Parameters.
 - b. **Modify the screen settings as desired:**
 - Incentive screen
 - Curves screen
 8. When the patient is ready, touch **Start pre #1** to perform the spirometry test.

Note Coach the patient through the effort.

The device stops automatically when air stops moving (that is, when the ATS end-of-test criteria are met).
 9. (Optional) touch **Stop** when the test has been completed.
 10. Decide whether to accept the effort.

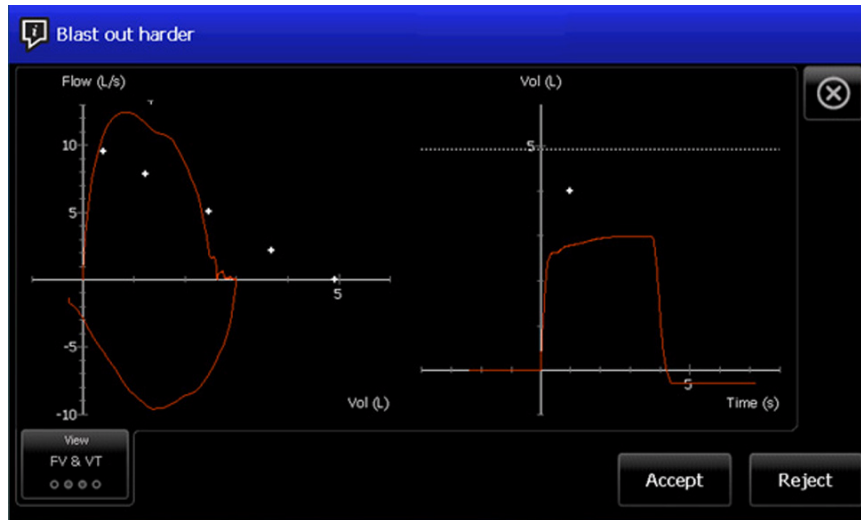

Note After each effort, a quality message appears on this screen, such as "Blast out harder," "Don't hesitate," "Blow out longer," or "Good effort."

11. Touch **Accept** to save the pre test and continue or touch **Reject**.

If the test is accepted or rejected, the next pre-test will increment in number. Even if some efforts were deleted, the test record indicates the patient's total number of efforts.

12. Continue with pre-test efforts, when finished touch **Pre-test done** to accept the pre-tests.

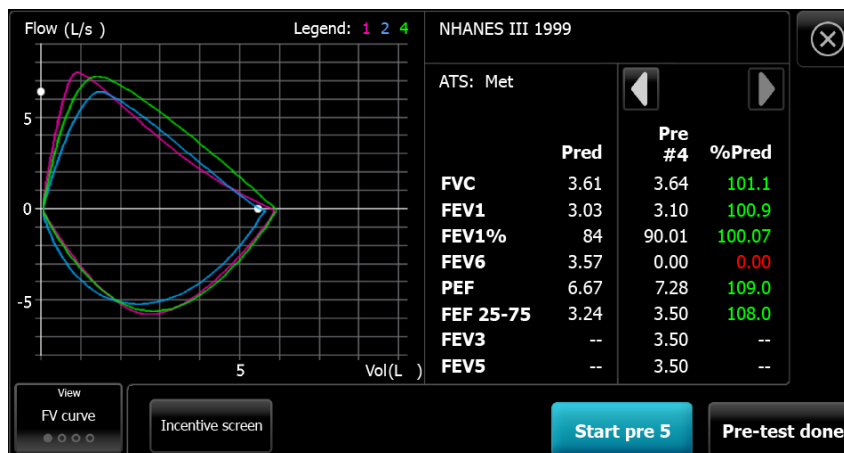

13. Touch **Print** to print the test report, touch **Test results** to preview the test report on the display, or touch **ATS Interpretation** to add or edit ATS interpretations. Touch **Print patient's education** to print patient help sheets. (See *About the patient help sheets* for further detail.) Touch **Start post test** to perform post medication efforts for the current patient, or touch **Return to pre test** to continue with FVC pre-test efforts.

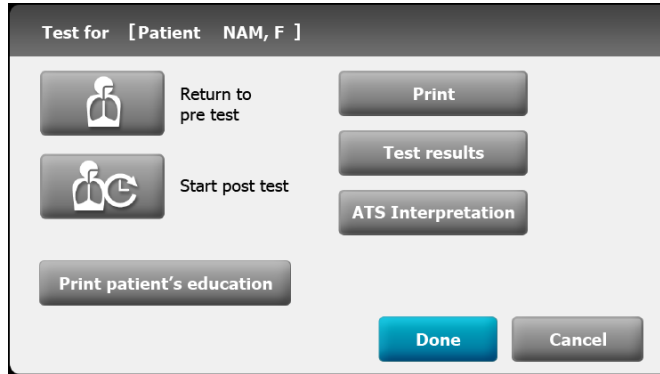

14. Touch **Done** when you have completed the pre-tests.

If the *Auto Save* setting is turned off, touch **Yes** and touch **Save** to save the test. Select one of the following locations:

- Local (internal memory)
- USB mass storage device (Any tests that you save to a USB mass storage device can be retrieved only from a CardioPerfect workstation.)
- Workstation
- Remote file location

Perform a spirometry test using the Search tab



CAUTION Patient data is not saved until the spirometry test is completed.

Note The spirometry configuration settings can be changed in the Settings tab. The following settings may appear differently if the default settings have been modified.

Note Set the Default patient entry tab to New patient in the Advanced settings.

1. Touch  (Perform new Forced Vital Capacity). The New patient tab appears.
2. Search for patient.

The Search tab gives you access to patient data in the Saved tests directory or in a connected database (CardioPerfect workstation or EMR).

- Touch the **Search** tab.
 - Enter the Patient ID or Last name.
 - Touch **OK**.
 - Touch **Search**.
 - Touch within the patient row.
 - Touch **Select** to review or edit patient information.
 - Touch  (Next) and enter patient height.
 - Touch **OK**.
3. Touch **View** or **Incentive** to select the display information that you want to view during the test.
 4. When the patient is ready, touch **Start pre #1** to perform the spirometry test.

Note See *Performing a new Forced Vital Capacity spirometry test* for additional details.



Perform a spirometry test using the Worklist tab when connected to the Worklist server



CAUTION Patient data is not saved until the spirometry test is completed.

Note The spirometry configuration settings can be changed in the Settings tab. The following settings may appear differently if the default settings have been modified.

Note Set the Default patient entry tab to Worklist in the Advanced settings.

1. Touch  (Perform new Forced Vital Capacity).
The worklist is downloaded from the EMR server and the Worklist tab appears.
2. Touch within the Patient row.
 - Touch **Select** to review or edit patient information.
 - Touch  (Next).
 - Enter patient height. Touch **OK**.
 - Touch  (Next).
3. Touch **View** or **Incentive** to select the display information that you want to view during the test.
4. When the patient is ready, touch **Start pre #1** to perform the spirometry test.

Note See *Performing a new Forced Vital Capacity spirometry test* for additional details.

Continue saved test



CAUTION Patient data is not saved until the spirometry test is completed.

Note The spirometry configuration settings can be changed in the Settings tab. The following settings may appear differently if the default settings have been modified.

1. From the Spirometry home screen touch  (Continue saved test). The Spirometry saved tests screen appears.



Patient ID	Patient name	Date of birth
55459001	NAM, F	07/11/1954
234890	NAM, F	09/05/1949
889902	NAM, F	03/02/1961

2. Select a patient from the list of saved tests. Touch within the Patient row.
3. Touch **Continue test**.
4. Touch **View** or **Incentive** to select the display information that you want to view during the test.
 - a. **Modify the View settings as desired:**
 - View Flow/Volume. (View FV curve)
 - View Volume/Time. (View VT curve)
 - View Flow/Volume and Volume/Time. (View FV & VT)
 - View Parameters.
 - b. **Modify the screen settings as desired:**
 - Incentive screen
 - Curves screen
5. When the patient is ready, touch **Start post #_** to perform the spirometry test.

Note Coach the patient through the effort.

The device stops automatically when air stops moving (that is, when the ATS end-of-test criteria are met).

6. (Optional) touch **Stop** when the test has been completed.
7. Decide whether to accept the effort.
8. Touch **Accept** to save the post test and continue or touch **Reject**.

If a test is rejected the next post-test will increment in number. Even if some efforts were deleted, the test record indicates the patient's total number of efforts.
9. Continue with post-test efforts, when finished touch **Post-test done** to accept the post-tests.
10. Touch **Print** to print the test report, touch **Test results** to preview the test report, or touch **ATS Interpretation** to add or edit ATS interpretations. Touch **Print patient's education** to print patient help sheets. (See *About the patient help sheets* for further detail.) Touch **Return to post test** to continue with FVC post-test efforts.
11. Touch **Done** when you have completed the post-tests.

If the *Auto Save* setting is turned off, touch **Yes** and touch **Save** to save the test. Select one of the following locations:

 - Local (internal memory)

- USB mass storage device (Any tests that you save to a USB mass storage device can be retrieved only from a CardioPerfect workstation.)
- Workstation
- Remote file location

Perform a spirometry post test

Complete the pre-test efforts. See *Perform a new Forced Vital Capacity spirometry test*.

Note Pre- and post-efforts must happen on the same day. The next day tests become available for review only; you can no longer add efforts to them.

1. Touch  (Continue saved test).
The Spirometry saved tests screen appears.
2. Select a patient from the list of saved tests. Touch within the Patient row.
3. Touch **Continue test**.
4. When the patient is ready, touch **Start post #_**.

Note Coach the patient through the effort.

5. The device stops automatically when air stops moving (that is when the ATS end-of-test criteria are met.)
6. (Optional) Touch **Stop** when the test has completed.
7. Decide whether to accept the effort.
8. Touch **Accept** to save the post test and continue or touch **Reject**.
If a test is accepted or rejected the next post-test will increment in number. Even if some efforts were deleted, the test record indicates the patient's total number of efforts.
9. Touch **Post-test done** to accept the post-test.
10. Touch **Print** to print the test report, touch **Test results** to preview the test report, or touch **ATS Interpretation** to add or edit ATS interpretations. Touch **Return to post test** to continue performing post medication efforts for the current patient.

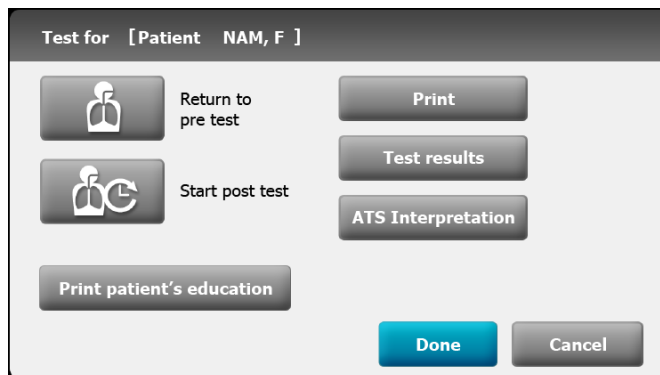

11. Touch **Done** when you have completed the post-tests.
12. Touch **Yes** and touch **Save** to save the test. Select one of the following locations:
 - Local (internal memory)
 - USB mass storage device (Any tests that you save to a USB mass storage device can be retrieved only from a CardioPerfect workstation.)

- Workstation
- Remote file location

Work with a Saved test

To view Saved tests:

1. From the Spirometry home tab, touch the **Saved tests** tab. Search for tests by Date, Last name, or Patient ID. Alternatively, you can search for All test types.
2. Enter the Date, or Patient's Last name, or Patient's ID and touch **OK**. Select the Test type.
3. Touch **Search**.
4. Touch the check box next to the desired test to select the test and then touch **Review**.

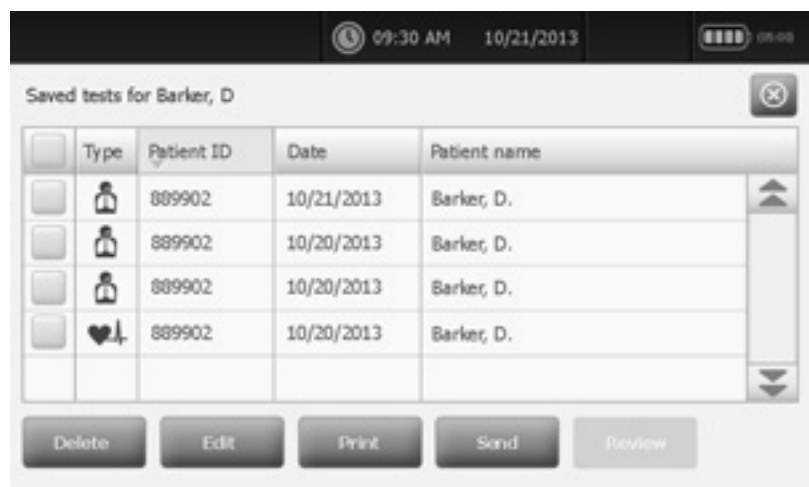

Note Review is not active until a test is selected. Only a single spirometry test can be reviewed at a time.

Note Spirometry tests are denoted with a  icon in the Test type column.

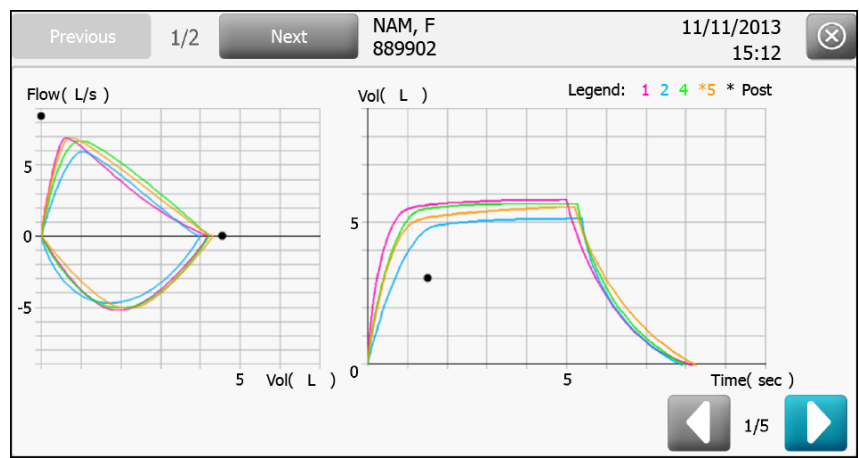

View and Print options include test efforts with color-coded legend, parameters with norm profile, efforts summary, and ATS Interpretive results.

Troubleshooting

Symptoms and solutions

Problem-solving suggestions:

If you try these suggestions and still have problems, contact Welch Allyn.

Symptom	Possible cause	Suggested action
Unable to calibrate	Poor connection between flow transducer and sensor	Check the connection between flow transducer and sensor.
	Damage to flow transducer	Replace the flow transducer if it is damaged.
	Leak during calibration.	Ensure that the connection between the calibration syringe and flow transducer is tight with no leaks.
	Uneven calibration strokes.	Use even strokes in calibration.
	Pressure tubing is kinked	Replace pressure tubing.
No sensor detected	Poor connection between the sensor and the device	Connect to another USB port. Replace the USB cable.
Does not print	Out of paper	Load paper. See the electrocardiograph manual.
	Paper jam	If the paper is jammed, clear it, then reload.
Values are too high (intermittent)	Patient's fingers obstructed the screen on the back of the flow transducer, causing high back pressure and false reading	Retest.
	Patient's lips were not tightly sealed around the flow transducer	Retest.
	Spirometer was calibrated with the wrong size syringe	Recalibrate with a 3-liter syringe. See <i>Performing a calibration</i> .

Symptom	Possible cause	Suggested action
Values are too high (consistently)	Pressure connection is partially obstructed	Remove any foreign substance from the flow transducer or pressure tubing.
Predictive values are blank	The selected norm does not support certain values, and composite norm values are disabled	<p>Re-enter age/birthdate, height, gender, race. (Fill in the fields. All mandatory fields must be filled in before you can proceed.)</p> <hr/> <p>Enable composite norm values. See <i>Viewing or changing the spirometry settings</i>.</p>
The flow sensor has been dropped.	Accident	Recalibrate. See <i>Performing a calibration</i> .
Report does not print parameters or graphs.	Improper parameter settings	Check print settings. See <i>Viewing or changing the spirometry settings</i> .
Patient test values differ from values expected by physician.	Various	<p>If the transducer is contaminated with sputum or secretions, replace it.</p> <hr/> <p>Verify that proper barometric pressure has been entered. See <i>Performing a calibration</i>.</p> <hr/> <p>Verify the patient data.</p> <hr/> <p>Eliminate any leaks in the pressure tubing.</p> <hr/> <p>Retest using a nose clip.</p> <hr/> <p>Replace the sensor if damaged.</p> <hr/> <p>Recalibrate.</p> <hr/> <p>Replace the transducer and retest.</p>

Maintenance

Cleaning the spirometer, calibration syringe, and patient handle



WARNING Change the flow transducer for each patient.



WARNING Satisfactory maintenance procedures must be implemented, or equipment failure and health hazards may result. Only qualified service personnel should repair the equipment.



CAUTION You cannot clean the spirometer or any of its components.



CAUTION Do not clean the pressure tubing or sensor. Trapped moisture could affect accuracy.



CAUTION Replace the pressure tubing when it becomes dirty or every 3 months, whichever comes first. Recalibrate after replacement.



CAUTION Replace the sensor when it becomes faulty.

Cleaning the calibration syringe

Wipe the outer surface of the calibration syringe with a clean cloth slightly dampened with 70 percent isopropyl alcohol.

Cleaning the patient handle



WARNING Keep the patient handle clean. Patient contact with contaminated equipment can spread infection.

Note Clean the patient handle after each patient use.

Clean on a routine basis according to your facility's protocols and standards or local regulations.

The following cleaning and disinfection agents are compatible with the patient handle:

- 70 percent isopropyl alcohol
- 10 percent chlorine bleach solution



CAUTION When cleaning the patient handle, do not use cloths or solutions that include quaternary ammonium compounds (ammonium chlorides) or glutaraldehyde-based disinfectants.

Note

Disinfect according to your facility's protocols and standards or local regulations.

Storing the equipment

When storing the electrocardiograph, cords, and accessories, observe the environmental storage conditions that are identified in the product specifications.

Disposing of electronic equipment



■ This product and its components must be disposed of according to local laws and regulations. Do not dispose of this product as unsorted municipal waste.

For more specific disposal or compliance information, see www.welchallyn.com/weee, or contact Welch Allyn Customer Service.

General compliance and standards

The CP150 complies with the following standards:

ANSI/AAMI EC11**	CAN/CSA C22.2 No. 601.1	CAN/CSA C22.2 No. 601.1.2
IEC/EN 60601-1	IEC/EN 60601-1-2	IEC/EN 60601-1-4
CAN/CSA C22.2 No. 601.1.4	CAN/CSA C22.2 No. 601.2.25	
IEC/EN 60601-1-6	IEC/EN 60601-2-25 ***	IEC/EN 60601-2-51* (3x4 report format)
ANSI/AAMI EC53	EN 50581	EN/IEC 62304
EN/IEC 62366	EN/ISO 14971	EN/ ISO 10993-1
EN/ISO 26782 (Spirometry Option)		

Declaration of Conformity

Available upon request.

General radio compliance

The wireless features of this device must be used in strict accordance with the manufacturer's instructions as described in the user documentation that comes with the device.

This device complies with Part 15 of the FCC rules and with the rules of the Canadian ICES-003 as described below.

Federal Communications Commission (FCC)

This device complies with part 15 of the FCC Rules. Operation is subject to the following two conditions:

- This device may not cause harmful interference.
- This device must accept any interference received, including interference that may cause undesired operation.

This equipment has been tested and found to comply with the limits for a Class B digital device, pursuant to Part 15 of FCC Rules. These limits are designed to provide

reasonable protection against harmful interference in a residential installation. This equipment generates, uses, and can radiate radio frequency energy. If not installed and used in accordance with the instructions, it may cause harmful interference to radio communications. However, there is no guarantee that interference will not occur in a particular installation. If this equipment does cause harmful interference to radio or television reception, which can be determined by turning the equipment off and on, the user is encouraged to try and correct the interference by one or more of the following measures:

- Reorient or relocate the receiving antenna
- Increase the distance between the equipment and the receiver
- Connect the equipment to an outlet on a circuit different from that to which the receiver is connected
- Consult the dealer or an experienced radio/TV technician for help

The user may find the following booklet prepared by the Federal Communications Commission helpful:

The Interference Handbook

This booklet is available from the U.S. Government Printing Office, Washington, D.C. 20402. Stock No. 004-000-0034504.

Welch Allyn is not responsible for any radio or television interference caused by unauthorized modification of the devices included with this Welch Allyn product, or the substitution or attachment of connecting cables and equipment other than specified by Welch Allyn.

The correction of interference caused by such unauthorized modification, substitution, or attachment will be the responsibility of the user.

Industry Canada (IC) emissions

This device complies with RSS 210 of Industry Canada.

Operation is subject to the following two conditions: (1) this device may not cause interference, and (2) this device must accept any interference, including interference that may cause undesired operation of this device.

L'utilisation de ce dispositif est autorisée seulement aux conditions suivantes: (1) il ne doit pas produire de brouillage et (2) l'utilisateur du dispositif doit être prêt à accepter tout brouillage radioélectrique reçu, même si ce brouillage est susceptible de compromettre le fonctionnement du dispositif.

This Class B digital apparatus complies with Canadian ICES-003.

Cet appareil numérique de la classe B est conforme à la norme NMB-003 du Canada.

RF Radiation Hazard Warning

Using higher gain antennas and types of antennas not certified for use with this product is not allowed. The device shall not be co-located with another transmitter.

Cet avertissement de sécurité est conforme aux limites d'exposition définies par la norme CNR-102 relative aux fréquences radio.

This radio transmitter (Contains IC ID: 3147A-WB45NBT) has been approved by Industry Canada to operate with the antenna types listed in table above with the maximum permissible gain and required antenna impedance for each antenna type indicated. Antenna types not included in this list, having a gain greater than the maximum gain indicated for that type, are strictly prohibited for use with this device.

Le présent émetteur radio (Contient l'ID de l'IC : 3147A-WB45NBT) a été approuvé par Industrie Canada pour fonctionner avec les types d'antenne énumérés ci-dessous et ayant un gain admissible maximal et l'impédance requise pour chaque type d'antenne. Les types d'antenne non inclus dans cette liste, ou dont le gain est supérieur au gain maximal indiqué, sont strictement interdits pour l'exploitation de l'émetteur.

Under Industry Canada regulations, this radio transmitter may only operate using an antenna of a type and maximum (or lesser) gain approved for the transmitter by Industry Canada. To reduce potential radio interference to other users, the antenna type and its gain should be so chosen that the equivalent isotropically radiated power (e.i.r.p.) is not more than that necessary for successful communication.

Conformément à la réglementation d'Industrie Canada, le présent émetteur radio peut fonctionner avec une antenne d'un type et d'un gain maximal (ou inférieur) approuvé pour l'émetteur par Industrie Canada. Dans le but de réduire les risques de brouillage radioélectrique à l'intention des autres utilisateurs, il faut choisir le type d'antenne et son gain de sorte que la puissance isotrope rayonnée équivalente (p.i.r.e.) ne dépasse pas l'intensité nécessaire à l'établissement d'une communication satisfaisante.

This device complies with Industry Canada license-exempt RSS standard(s). Operation is subject to the following two conditions: (1) this device may not cause interference, and (2) this device must accept any interference, including interference that may cause undesired operation of the device.

Le présent appareil est conforme aux CNR d'Industrie Canada applicables aux appareils radio exempts de licence. L'exploitation est autorisée aux deux conditions suivantes : (1) l'appareil ne doit pas produire de brouillage, et (2) l'utilisateur de l'appareil doit accepter tout brouillage radioélectrique subi, même si le brouillage est susceptible d'en compromettre le fonctionnement.

EMC guidance and manufacturer's declarations

EMC compliance

Special precautions concerning electromagnetic compatibility (EMC) must be taken for all medical electrical equipment. This device complies with IEC 60601-1-2:2014/EN 60601-2-1:2015.

- All medical electrical equipment must be installed and put into service in accordance with the EMC information provided in this *Directions for use*.
- Portable and mobile RF communications equipment can affect the behavior of medical electrical equipment.

The device complies with all applicable and required standards for electromagnetic interference.

- It does not normally affect nearby equipment and devices.
- It is not normally affected by nearby equipment and devices.
- It is not safe to operate the monitor in the presence of high-frequency surgical equipment.

- However, it is good practice to avoid using the device in extremely close proximity to other equipment.

Note The CP 150 spirometry option has essential performance requirements associated with spirometry. In the presence of EM disturbances, the device will display an error code. Once the EM disturbances stop the CP 150 spirometry option will self-recover and perform as intended.



WARNING The use of the CP 150 spirometry option adjacent to or stacked with other equipment or medical electrical systems should be avoided because it could result in improper operation. If such use is necessary, the CP 150 spirometry option and other equipment should be observed to verify that they are operating normally.



WARNING Use only Accessories recommended by Welch Allyn for use with the CP 150 spirometry option. Accessories not recommended by Welch Allyn may affect the EMC emissions or immunity.



WARNING Maintain minimum separation distance between the CP 150 spirometry option and portable RF communication equipment. Performance of the CP 150 spirometry option may be degraded if proper distance is not maintained.

Emissions and immunity information

Electromagnetic emissions

The CP 150 spirometry option is intended for use in the electromagnetic environment specified below. The customer or user of the CP 150 spirometry option should assure that it is used in such an environment.

Emissions test	Compliance	Electromagnetic environment - guidance
RF emissions CISPR 11	Group 1	The CP 150 spirometry option uses RF energy only for its internal function. Therefore, its RF emissions are very low and are not likely to cause any interference in nearby electronic equipment.
RF emissions CISPR 11	Class A	The EMISSIONS characteristics of this equipment make it suitable for use in industrial areas and hospitals (CISPR 11 class A). If it is used in a residential environment (for which CISPR 11 class B is normally required) this equipment might not offer adequate protection to radio-frequency communication services. The user might need to take mitigation measures, such as relocating or re-orienting the equipment.
Harmonic emissions IEC 61000-3-2	Class A	
Voltage fluctuations/ flicker emissions IEC 61000-3-3	Complies	 WARNING This equipment/system is intended for use by healthcare professionals only. This equipment/ system may cause radio interference or may disrupt the operation of nearby equipment ^a . It may be necessary to take mitigation measures, such as re-orienting or relocating the CP 150 spirometry option or shielding the location.

^a The CP 150 spirometry option contains a 5-GHz orthogonal frequency-division multiplexing transmitter or a 2.4-GHz frequency hopping spread-spectrum transmitter for the purpose of wireless communication. The radio is operated according to the requirements of various agencies, including FCC 47 CFR 15.247 and Radio Equipment Directive 2014/53/

Electromagnetic emissions

EU. The transmitter is excluded from the EMC requirements of 60601-1-2, but should be considered when addressing possible interference issues between this and other devices.

Electromagnetic immunity

The CP 150 spirometry option is intended for use in the electromagnetic environment specified below. The customer or the user of the CP 150 spirometry option should assure that it is used in such an environment.

Immunity test	IEC 60601 test level	Compliance level	Electromagnetic environment - guidance
Electrostatic discharge (ESD) IEC 61000-4-2	±8 kV contact ±15 kV air	±8 kV ±15 kV	Floors should be wood, concrete or ceramic tile. If floors are covered with synthetic material, the relative humidity should be at least 30%.
Electrical fast transient/burst IEC 61000-4-4	±2 kV for power supply lines ±1 kV for input/output lines	±2 kV ±1 kV	Mains power quality should be that of a typical commercial or hospital environment.
Surge IEC 61000-4-5	±0.5 kV, ±1 kV Line- to -line ±0.5 kV, ±1 kV, ±2 kV Line-to-ground	±1 kV ±2 kV	Mains power quality should be that of a typical commercial or hospital environment.
Voltage dips, short interruptions and voltage variations on power supply input lines IEC 61000-4-11	0 % U_T ; 0.5 cycle At 0°, 45°, 90°, 135°, 180°, 225°, 270° and 315° 0 % U_T ; 1 cycle 70 % U_T ; 25/30 cycles Single phase: at 0° 0 % U_T ; 250/300 cycle	0 % U_T ; 0.5 cycle 0 % U_T ; 1 cycle 70 % U_T ; 25/30 cycles 0 % U_T ; 250/300 cycle	Mains power quality should be that of a typical commercial or hospital environment. If the user of the CP 150 spirometry option requires continued operation during power mains interruptions, it is recommended that the CP 150 spirometry option be powered from an uninterruptible power supply or a battery.
Power frequency (50/60 Hz) magnetic field IEC 61000-4-8	30 A/m	30 A/m	Power frequency magnetic fields should be at levels characteristic of a typical location in a typical commercial or hospital environment.

Note: U_T is the a.c. mains voltage prior to application of the test level.

Electromagnetic immunity

The CP 150 spirometry option is intended for use in the electromagnetic environment specified below. The customer or the user of the CP 150 spirometry option should assure that it is used in such an environment.

Immunity test	IEC 60601 test level	Compliance level	Electromagnetic environment - guidance
			Portable and mobile RF communications equipment should be used no closer to any part of the CP 150 spirometry option, including cables, than the recommended separation distance calculated from the equation applicable to the frequency of the transmitter.
Recommended separation distance			
Conducted RF IEC 61000-4-6	3 Vrms 150 kHz to 80 MHz	3 Vrms	$d = \left[\frac{3.5}{V_1}\right]\sqrt{P}$
	6Vrms in ISM and amateur radio bands between 150 kHz and 80 MHz.	6Vrms .	$d = \left[\frac{12}{V_2}\right]\sqrt{P}$
Radiated RF IEC 61000-4-3	10 V/M, 80 MHz to 2.7 GHz	10 V/M	$d = \left[\frac{23}{E_1}\right]\sqrt{P}$ 800 MHz to 2.7 GHz
			$d = \left[\frac{12}{E_1}\right]\sqrt{P}$ 80 MHz to 800 MHz

where P is the maximum output power rating of the transmitter in watts (W) and d is the recommended separation distance in meters (m). Field strengths from fixed RF transmitters, as determined by an electromagnetic site survey^a, should be less than the compliance level in each frequency range^b. Interference may occur in the vicinity of equipment marked with the following symbol:



Note1: At 80 MHz and 800 MHz, the higher frequency range applies.

Note 2: These guidelines may not apply in all situations. Electromagnetic propagation is affected by absorption and reflection from structures, objects, and people.

^aField strengths from fixed transmitters, such as base stations for radio (cellular/cordless) telephones and land mobile radios, amateur radio, AM and FM radio broadcast, and TV broadcast cannot be predicted theoretically with accuracy. To assess the electromagnetic environment due to fixed RF transmitters, an electromagnetic site survey should be considered. If the measured field strength in the location in which the CP 150 spirometry option is used exceeds the applicable RF compliance level above, the CP 150 spirometry option should be observed to verify normal operation. If abnormal performance is observed, additional measures may be necessary, such as reorienting or relocating the CP 150 spirometry option.

^bOver the frequency range 150 kHz to 80 MHz, field strengths should be less than 3 V/m.

Recommended separation distances between portable and mobile RF communications equipment and the CP 150 spirometry option

The CP 150 spirometry option is intended for use in an electromagnetic environment in which radiated RF disturbances are controlled. The customer or user of the CP 150 spirometry option can help prevent electromagnetic interference by maintaining a minimum distance between portable and mobile RF communications equipment (transmitters) and the CP 150 spirometry option as recommended below, according to the maximum output power of the communications equipment.

Separation distance according to frequency of transmitter (m)				
Rated max. output power of transmitter (W)	150 kHz to 80 MHz outside ISM bands	150 kHz to 80 MHz in ISM bands	80 MHz to 800 MHz	800 MHz to 2.7 GHz
	$d = [\frac{3.5}{V_1}] \sqrt{P}$	$d = [\frac{12}{V_2}] \sqrt{P}$	$d = [\frac{12}{E_1}] \sqrt{P}$	$d = [\frac{23}{E_1}] \sqrt{P}$
0.01	0.12	0.20	0.12	0.23
0.1	0.37	0.63	0.38	0.73
1	1.17	2.00	1.20	2.30
10	3.69	6.32	3.79	7.27
100	11.67	20.00	12.00	23.00

For transmitters rated at a maximum output power not listed above, the recommended separation distance *d* in meters (m) can be estimated using the equation applicable to the frequency of the transmitter, where *P* is the maximum output power rating of the transmitter in watts (W) according to the transmitter manufacturer.

Note 1: At 80 MHz and 800 MHz, the separation distance for the higher frequency range applies.

Note 2: These guidelines may not apply in all situations. Electromagnetic propagation is affected by absorption and reflection from structures, objects, and people.

Test specifications for enclosure port immunity to RF wireless communications equipment

Test frequency (MHz)	Band ^a MHz	Service ^a	Modulation ^b	Maximum power (W)	Distance (m)	Immunity test level (V/m)
385	380 - 390	TETRA 400	Pulse modulation ^b 18 Hz	1.8	0.3	27
450	430 - 470	GMRS 460, FRS 460	FM ^c ±5 kHz deviation 1 kHz sine	2	0.3	28
710	704 - 787	LTE band 13, 17	Pulse modulation ^b 217 Hz	0.2	0.3	9
745						
780						
810	800 - 960	GSM 800/900, TETRA 800,	Pulse modulation ^b	2	0.3	28

Test specifications for enclosure port immunity to RF wireless communications equipment

870		iDEN 820, CDMA 850, LTE Band 5	18 Hz			
930						
1720	1700 - 1990	GSM 1800; CDMA 1900; GSM 1900; DECT; LTE Band 1, 3, 4, 25; UMTS	Pulse modulation ^b 2 217 Hz	0.3		28
1845						
1970						
2450	2400 - 2570	Bluetooth, WLAN, 802.11 b/g/n, RFID 2450, LTE Band 7	Pulse modulation ^b 2 217 Hz	0.3		28
5240	5100 - 5800	WLAN 802.11 a/n	Pulse modulation ^b 0.2 217 Hz	0.3		9
5500						
5785						

^a For some services, only the uplink frequencies are included.

^b The carrier shall be modulated using a 50 percent duty cycle square wave signal.

^c As an alternative to FM modulation, 50 percent pulse modulation at 18 Hz may be used because while it does not represent actual modulation, it would be worst case.

Specifications

Item	Specification
Dimensions and weights	
Flow transducer	1.5 x 1.2 x 3.3 in. (37 mm x 30 mm x 85 mm) 0.4 oz (12 g)
Pressure tubing	2.2 yd (2 m) 0.9 oz (25 g)
Sensor	1.2 x 4.3 x 0.6 in (31 mm x 108 mm x 14 mm) 0.9 oz (25 g)
Tests	FVC, pre- and post-bronchodilator
Flow technology	Pneumotach
Power equipment	Powered by CP150 electrocardiograph via USB port (no battery)
Current consumption	50 mA Max (30 mA typical)
Mode of operation	Continuous
Accuracy	± 3.0 percent of the reading. Compliant with ATS/ERS 2005 guidelines. Compliant with ISO 26782:2009.
Time zero	Determination of time zero in FVC is by back extrapolation.
Temperature correction	The values displayed by the Spirometer are expressed as BTPS values. (Software-based)
Back pressure/expiratory impedance	The expiratory impedance of the spirometer (including accessories) is less than 0.06 kPa/(L/s).
Flow range	0–14 L/s
Predictive norms	Berglund 1963, Crapo 1981, ECCS / Quanjer 1993, Falaschetti 2004, Forche II, Gore 1995, Gulsvik 2001, Hedenström 1986, Knudson 1976, Knudson 1983, Kory 1961,

Item	Specification
	Morris 1971, NHANES III 1999, Paoletti 1986, Roca 1986, Schoenberg 1978, Viljanen 1981
Interpretation	1991 ATS interpretation standards Lung age calculation can be enabled or disabled. Automatic interpretation can be enabled or disabled. User-definable interpretation statements are also available to be added manually.
Reports	
FVC testing	Volume/time curve Flow/volume curve Both volume/time and displayed curves No curves None
Parameters	
FVC testing	FVC, FIVC, FIV1, FIV1%, FEV0.5, FEV1, FEV2, FEV3, FEV5, FEV6, FEV1/FEV6, FEV0.5%, FEV1%, FEV2%, FEV3%, FEV5%, FEV6%, PEF, FEF25, FEF50, FEF75, FEF0.2-1.2, FEF25-75, FEF75-85, PIF, FIF50, FEF50/FIF50, FET
Quality checks	Effort acceptability and test reproducibility checks. Effort-quality messages and test-quality grades. Visual incentive for assistance in coaching patients.
Standard connectivity	1 USB client 4 USB hosts WiFi Ethernet
Connectivity with electronic medical records	Compatible with CardioPerfect workstation. Compatible with worklist server.
Electrocardio protection against ingress of water, per IEC 60529	IPX0
Spirometer protection against ingress of water, per IEC 60529	IP20
Protocols	PCP (primary care practitioner), NIOSH, None
Environmental operating conditions	
Temperature	+10° C to +40° C (+50° F to +104° F)
Relative humidity	10 - 95% noncondensing

Item	Specification
Atmospheric air-pressure limits 500 - 1060 hPa	
Environmental storage conditions	
Temperature	-20° C to +50° C (-4° F to +122° F)
Relative humidity	10 - 95% noncondensing
Atmospheric air-pressure limits 500 - 1060 hPa	

Specifications are subject to change without notice.

Limited warranty

For general information on the limited warranty, see the electrocardiograph manual entitled *CP 150 12-lead resting electrocardiograph Directions for use*.

The following spirometry components have specific warranty periods from date of shipment to customer:

- Sensor — 12 months
- Calibration syringe — 12 months

Service policy

For general information on the service policy, see the electrocardiograph manual entitled *CP 150 12-lead resting electrocardiograph Directions for use*.

The following spirometry components have specific service policies. For disposable items, see the *Approved Accessories*.

Flow transducer — Disposable.

Pressure tubing — Disposable.

Sensor — Return to Welch Allyn for replacement if necessary. Replacement is free within the warranty period.

Syringe — Return to the manufacturer for calibration verification if necessary. Recalibration is free within the warranty period. Beyond the warranty period, return to the manufacturer:

AM Systems, Inc.

131 Business Park Loop

Carlsborg, WA 98324

(800) 426-1306

Spirometry protocols

This manual describes the protocols you can select to change the way the CP 150 spirometer operates when testing a patient. Any features that are not specified in the protocol use your own settings.

Protocol settings are uneditable after selection to avoid confusion during setup.

To learn how to review or change the protocol, see [Viewing or changing the spirometry settings](#).

About the PCP protocol

The PCP (primary care practitioner) protocol is for users who want to make sure that testing meets the requirement of the National Lung Health Education Program (NLHEP). When the PCP protocol is selected, the spirometer automatically performs as described here, regardless of user-defined settings.

When this protocol is selected, testing and reports are affected as follows:

Operation Settings

- Norm: NHANES III 1999 (Adult)
- Best Effort Formula: Best Measurement
- FVC Reversibility formula: $((\text{Post-Pre})/\text{Pre}) * 100$
- FEV1% formula: FEV6
- ATS interpretation: True
- Composite norms: False
- Displaying parameters: FEV1, FEV6, FEV1/FEV6
- Efforts to be printed: Only best effort
- Print lung age: True
- Print quality grades: True

About the NIOSH protocol

The NIOSH (National Institute for Occupational Safety and Health, U.S.) protocol is for users who want to make sure that occupational testing and reports meet the requirements of NIOSH. The device automatically performs as described here, regardless of user-defined settings.

When using this protocol, the spirometer should be calibrated at three different flows every day before use.

When this protocol is selected, testing and reports are affected as follows:

Operation Settings

- Norm: NHANES III 1999 (Adult)
- Best Effort Formula: Best Measurement
- Composite norms: False
- Efforts to be printed: Three best efforts

About the patient help sheets

Two patient help sheets are available to print:¹

- Adult smokers

If *Smoke Years* is enabled in the FVC report settings, the Smokers' education sheet option can be printed for adult smokers.

- Asthma symptoms

These help sheets print only if patient education is selected. To enable patient education touch the **Print patient's education** button after the FVC efforts have been performed. Touch the checkbox next to Asthma education or Smokers' education.

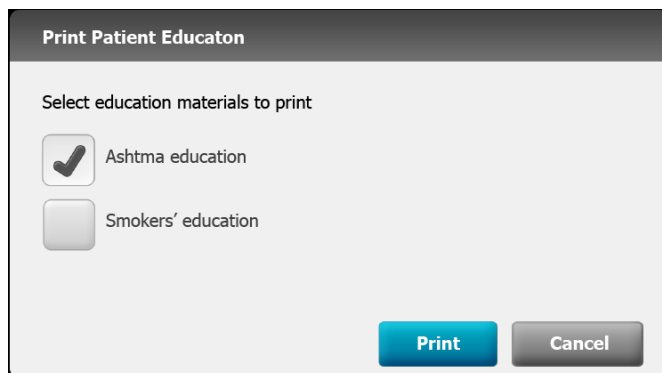

The patient's name, FEV1% predicted, and date print automatically on both sheets. If Enable ATS Interpretation is selected, the appropriate recommendation is also marked. To enable ATS Interpretation, touch the **Settings** tab. The ECG tab and the vertical ECG configuration tab appear. Touch the **Spirometry** tab. The vertical Spirometry

configuration tab appears. Touch the  (Next) button. Touch the checkbox next to the Enable ATS Interpretive.

Note If no recommendation is marked, the doctor must mark one.

1

Both help sheets come from a booklet entitled Simple Office Spirometry for Primary Care Practitioners, by Thomas L. Petty, MD, and Paul L. Enright, MD. This booklet can be downloaded from the National Lung Health Education Program (NLHEP) home page: <http://www.nlhep.org/Pages/Resources.aspx>.

Adult smokers help sheet

Name _____

What Your Lung Function Results Mean For Adult Smokers

You have just performed Spirometry, the basic test of how well your lungs are working. The results indicate whether you have developed chronic obstructive pulmonary disease (COPD) due to smoking. COPD occurs in about one of every five smokers after more than 20 years of smoking. COPD slowly "eats away" at the lung's reserves. Affected smokers are often unaware of lung disease until more than half of their lung function has been lost. Spirometry testing can detect COPD many years before symptoms occur.

___ Your test result was within the normal range. You do not appear to be developing COPD. However, as a smoker, you remain at high risk of developing a heart attack, stroke, and/or lung cancer. Call the number at the bottom of this page for help with smoking cessation.

___ Your test result shows mild airways obstruction, suggesting that you are a "susceptible smoker" who already shows signs of early COPD. You are unable to blow out air as quickly as normal (your FEV1/FVC is low). If you continue smoking, you will eventually develop disabling lung disease (in about 10-20 years). If you are able to successfully quit smoking sometime soon, your lung function may return to normal levels and you will probably never develop symptoms of COPD. Call the number at the bottom of this page if you would like information about local resources to help you quit smoking.

___ Your test result shows moderate-to-severe airways obstruction. You have COPD. If you continue smoking, your lung disease will certainly get worse and you will eventually become short of breath while walking, climbing stairs, or doing other exercise. It is very important that you seek help to stop smoking. If you are able to successfully quit smoking sometime soon, you will probably regain a little lung function within three months, and the abnormally rapid decline in your lung function which you have experienced due to smoking will be stopped. Call the number at the bottom of this page for information about local resources to help you quit smoking.

Your result: _____ FEV1 % predicted

For more information contact:

Date

Asthma symptoms help sheet

Name _____

What Your Lung Function Results Mean For Those With Symptoms Suggesting Asthma

You have just performed Spirometry, the basic test of how well your lungs are working. The results may indicate whether you have asthma and its severity.

___ Your test was within the normal range. If you recently had symptoms such as episodes of shortness of breath with wheezing, chest tightness, or cough, you may have asthma, but your lung function is normal today. Consider visiting a physician when you again have asthma symptoms and then repeat this Spirometry test. If you already know that you have asthma, it is in good control.

___ Your breathing test shows mild airways obstruction (some narrowing of your breathing tubes). You are currently unable to blow out air quickly. This result may indicate asthma that is not well controlled. Discuss with your physician medications to better control your asthma.

___ Your breathing test shows moderate-to-severe airways obstruction (narrowing of your breathing tubes). You are currently unable to blow out air quickly. This result usually indicates asthma that is poorly controlled. Discuss with your physician very soon the use of medications that will help to better control your asthma and the value of peak flow monitoring.

___ Your test shows a low forced vital capacity (FVC). Your FVC is the total amount of air that you exhaled, in liters (similar to quarts). Values below about 80% are abnormally low and suggest that you are unable to inhale or exhale as much air as most healthy persons of your age, height, gender, and race. Obesity may be one of the causes of a mildly decreased FVC, and pneumonia is another. Consider asking a physician to review this report at some time during the next couple of months.

Your result: _____ FEV1 % predicted

Your peak flow after inhaling a bronchodilator was _____ L/s (liters per second). You can compare this value to the peak flow that you measure using your own peak flow meter. The two numbers should match within 1 L/s. If your asthma is currently in good control, today's value may be close to your best peak flow reading at home.

Date

Predictive Norms and interpretation

About Norm extrapolation

Extrapolation is the practice of applying a norm's formula to a patient who is outside of the norm studied. For example, if you were testing an 88-year-old man, and the selected norm was based on males 85 or younger, the predicted values would be extrapolated values.

- Norm extrapolation is indicated in the test record.
- Most adult norms allow extrapolation of age up, but not down.
- Adult norms allow extrapolation of height and weight up and down.

About race adjustment

Although expected values for certain parameters vary significantly between ethnic groups, some norm studies do not include separate regression equations for different races. For those studies, the following table describes the adjustments made by the CP 150 software for the FVC and FEV1 predicted values. Where applicable, norm values are multiplied by the percentages identified in the following table.

Race Choices	FVC & FEV1	Recommendation Source
Caucasian	No adjustment	—
Black	88%	ATS
Asian	94%	NIOSH
Hispanic	No adjustment	None found
Native American	94%	NIOSH
Polynesian	94%	NIOSH
Aboriginal	94%	NIOSH
Indian	94%	NIOSH

Note Race adjustment applies for adults only.

If a race adjustment percentage is used, the same adjustment is applied to the LLN value.

About composite Norm values

When the primary (selected) norm does not support a given parameter — and when composite norm values are enabled in the operation settings — the missing value is filled in from one of the alternative (composite) norm sources, listed here. For example, since the Crapo norm does not support FEV6, this value is filled in from NHANES III.

Composite Norm Source	Parameters Filled In When Not Supported in Primary Norm
NHANES III	FVC, FEV1, FEV1%, FEV6, FEV1/FEV6, PEF, FEF25-75
Crapo 1981	FEV0.5, FEV3, FEV3/FVC
Morris 1971	FEF0.2-1.2
ECCS/Quanjer 1993	FEF25, FEF50, FEF75

The primary norm takes precedence over the composite source. For example, since the Crapo norm supports the FVC parameter, this value always comes from Crapo, not from the composite source.

Composite values are used when the patient does not fit the demographics of either primary norm (adult or pediatric). For example, if the primary norms are Kory and Morris, a 14-year-old patient fits neither norm due to age restrictions. The software would use values from the appropriate composite norms, for example, NHANES III or ECCS/Quanjer 1993. It would not use values from Kory or Morris.

On the screen and in reports, an abbreviation identifies the norm source for each composite value used. For example, the abbreviation for Roca is “ro.”

To enable or disable composite norm values, see *Viewing or changing the spirometry settings*.

About lung age

Lung age is a calculated value based on a patient’s demographics and spirometric performance that gives a relative indication of the health of the subject's lungs. This value is used primarily to encourage smoking cessation.

The CP 150 spirometer calculates lung age values according to the document *Short Report Spirometric "Lung Age" Estimation for Motivating Smoking Cessation*. (Morris 1995). For single-effort tests, lung age is based on the current effort. Otherwise, it is based on the patient’s “best” effort, as defined in the settings.

Lung age results less than 20 years are reported as “<20,” and results greater than 84 are reported as “>84.” This limitation is derived from the subject population on which Morris based his research.

Lung age, which is expressed in years, is the average of the four formulas in the Morris article (FVC, FEV1, FEF25-75%, and FEF0.2-1.2). Specifically, lung age is calculated as follows:

Gender	Lung Age Formula
Men	$[5.920 (\text{height}) - 40.000 (\text{FVC}) - 169.640 +$

Gender	Lung Age Formula
	$2.870 (\text{height}) - 31.250 (\text{FEV1}) - 39.375 +$
	$2.319 (\text{height}) - 21.277 (\text{FEF200-1200}) + 42.766 +$
	$1.044 (\text{height}) - 22.222 (\text{FEF25\%-75\%}) + 55.844] / 4$
Women	$[4.792 (\text{height}) - 41.667 (\text{FVC}) - 118.833 +$
	$3.560 (\text{height}) - 40.000 (\text{FEV1}) - 77.280 +$
	$4.028 (\text{height}) - 27.778 (\text{FEF200-1200}) - 70.333 +$
	$2.000 (\text{height}) - 33.333 (\text{FEF25\%-75\%}) + 18.367] / 4$

List of Norm-related clinical studies

Each of the following studies provides expected values for various spirometric parameters by measuring significant samples of a particular population.

Norm	Clinical Study Reference
Berglund 1963	<i>Spirometric Studies in Normal Subjects: Forced Expiratograms in Subjects 7-70 Years of Age</i> , Berglund, et. al., <i>Acta Medica Scandinavica</i> , volume 173, 1963.
Crapo 1981	<i>Reference Spirometric Values using Techniques and Equipment that Meet ATS Recommendations</i> , Crapo, et. al., <i>American Review of Respiratory Disease</i> 1981, 123:659-664.
Dockery 1983	<i>Distribution of Forced Vital Capacity and Forced Expiratory Volume in One Second in Children 6-11 Years of Age</i> , Dockery DW, et. al., <i>American Review of Respiratory Disease</i> , 1983, 128:405-412.
Falaschetti 2004	<i>Prediction equations for normal and low lung function from the Health Survey for England</i> , E. Falaschetti, J. Laiho, P. Primatesta, S. Purdon; <i>European Respiratory Journal</i> 2004; 23: 456–463.
Forche II 1988	<i>Neue spirometrische Bezugswerte für Kinder, Jugendliche und Erwachsene</i> ; Forche G., Harmoncourt K., Stadlober E.; <i>Österreichische Ärztezeitung</i> 43, 15-16, 1988.
GLI 2012 (Global Lung Initiative)	<i>Multi-ethnic reference values for spirometry for the 3–95-yr age range: the global lung function 2012 equations</i> , Quanjer Ph. H., et al., <i>European Respiratory Journal</i> 2012; 40: 1324–1343.
Hedenström 1986	<i>Reference Values for Lung Function Tests in Men: Regression Equations With Smoking Variables</i> , Hedenström, et. al., <i>Upsala Journal of Medicine Science</i> 91:299-310, 1986.
Hibbert 1989	<i>Lung function values from a longitudinal study of healthy children and adolescents</i> , Hibbert ME, Lanigan A., Landau LI, Phelan PD, <i>Pediatric pulmonology</i> , 7:101-109, 1989.
Hsu 1979	<i>Ventilatory Functions of Normal Children and Young Adults—Mexican-American, White and Black</i> . I. Spirometry, Katharine HK Hsu, et. al., <i>The Journal of Pediatrics</i> ; volume 95(1):14-23, July 1979.
Knudson 1976	<i>The Maximal Expiratory Flow-Volume Curve Normal Standards, Variability, and Effects of Age</i> , Ronald J. Knudson, Ronald C. Slatin, Michael D. Lebowitz, and Benjamin Burrows, et. al., <i>American Review of Respiratory Disease</i> , volume 113, 587-600, 1976.
Knudson 1983	<i>Changes in the Normal Expiratory Flow Volume Curve With Growth and Aging</i> , Ronald Knudson, et. al., <i>American Review of Respiratory Disease</i> , 1983, 127, 725-734.
Koillinen 1998	<i>Terveiden suomalaislasten spirometrian ja uloshengityksen huippuvirtauksen viitearvot</i> , Hannele Koillinen, et. al., <i>Suomen Laakarilehti</i> , 1998, 5 vsk 53, p. 395-402.
Kory 1961	<i>The Veterans Administration Army Cooperative Study of Pulmonary Function, Clinical Spirometry in Normal Men</i> , Kory, et. al., <i>American Journal of Medicine</i> , February 1961, 243-258.
Langhammer 2001	<i>Forced Spirometry Reference Values for Norwegian Adults: The Bronchial Obstruction in Nord-Trøndelag Study</i> , Langhammer A., Gulsvik A., et. al., <i>European Respiratory Journal</i> 2001, 18: 770-779.
Morris 1971	<i>Spirometric Standards for Healthy Non-smoking Adults</i> , James F. Morris, et. al., <i>American Review of Respiratory Disease</i> , volume 103, 57-67, 1971.

Norm	Clinical Study Reference
NHANES III	<i>Spirometric Reference Values from a Sample of the General U.S. Population</i> , John L. Hankinson, John R. Odencrantz, and Kathleen B. Fedan, et. al., Division of Respiratory Disease Studies, National Institute for Occupational Safety and Health, Centers for Disease Control and Prevention, Morgantown, West Virginia, 1999. The Third National Health And Nutrition Examination Survey (NHANES III). <u>Am J Respir Crit Care Med</u> Jan 1999; 159:179-187.
Polgar 1971	<i>Pulmonary Function Testing in Children: Techniques and Standards</i> , Polgar G. and Promadhat V. Philadelphia, WB Saunders, 1971.
Roca 1986	<i>Spirometric Reference Values From a Mediterranean Population</i> ; J. Roca, J. Sanchis, et. al.; <u>Bulletin Européen de Physiopathologie Respiratoire</u> , 1986, 22, 217-224.
Schoenberg 1978	<i>Growth and Decay of Pulmonary Function in Healthy Blacks and Whites</i> , Janet B. Schoenberg, Gerald J. Beck, and Arend Bouhuys, et. al., <u>Respiration Physiology</u> , 1978, 33, 367-393.
Solymar 1980	<i>Nitrogen Single Breath Test, Flow-Volume Curves and Spirometry in Healthy Children, 7 -18 Years of Age</i> , L. Solymar, P. H. Aronsson, B. Bake, and J. Bjure. <u>European Journal of Respir. Dis.</u> 1980, 61:275-286.
Viljanen 1981	<i>Spirometric Studies in Non-smoking, Healthy Adults</i> , Viljanen, et. al., <u>Journal of Clinical Lab Investigation</u> , 41 supplement 159, 5-20, 1981.
Wang 1993	<i>Pulmonary Function Between 6 and 18 Years of Age</i> , Xiaobin Wang, Douglas W. Dockery, David Wypij, Martha E. Fay, Benjamin G. Ferris, <u>Pediatric Pulmonology</u> 15:75-88 (1993)
Zapletal 1969	<i>Maximum Expiratory Flow-Volume Curves and Airway Conductance in Children and Adolescents</i> , A Zapletal, EK Motoyama, KP Van De Woestijne, VR Hunt and A. Bouhuys, <u>Journal of Applied Physiology</u> , vol. 26, no. 3:308-316, March 1969.

About quality feedback

The spirometer provides two kinds of quality feedback: effort-quality messages and test stage reproducibility, as described in the following sections.

About effort-quality messages

One of the following effort-quality messages appears on the screen after each effort is completed. These messages indicate whether an effort was acceptable and reproducible, and if not, what the patient needs to do differently.

Effort-quality message	Criteria
Don't hesitate	Back-extrapolated volume > 150 ml or 5%, whichever is greater.
Blast out faster	PEF time > 120 ms.
Blow out longer, no plateau	FET < 6.0 seconds, and (3 seconds) + plateau
Good effort	Effort is acceptable and reproducible.

Test stage reproducibility

- 3 or more acceptable efforts
- difference in FVC of best 2 efforts \leq 150 ml
- difference in FEV1 of best 2 efforts \leq 150 ml

Understanding your interpretation results

This diagram shows how the automatic interpretation software uses a patient's FVC and FEV1 results, in comparison with normal values, to determine the degree of obstruction or restriction. This diagram follows the American Thoracic Society's example for interpretation.

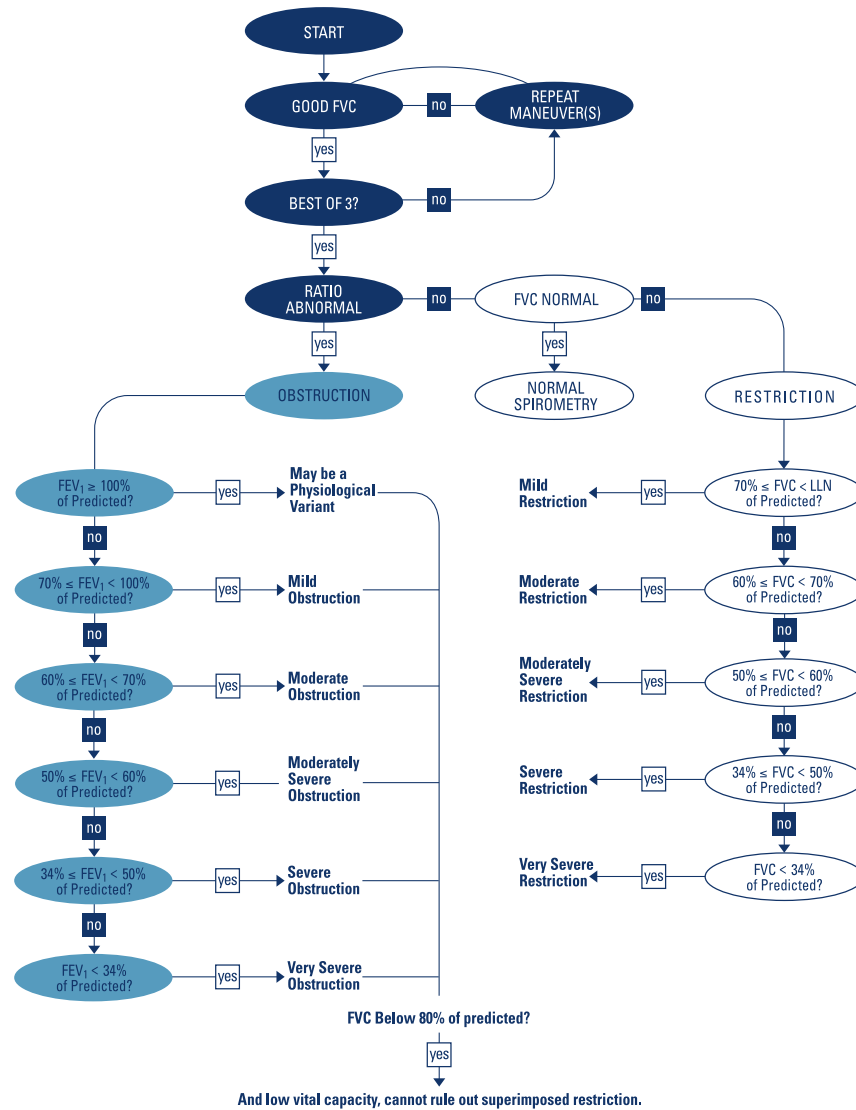

References

1. *Disability Evaluation Under Social Security* (the "blue book"), Social Security Administration SSA publication number 64-039, Office of Disability Programs ICN 468600, January 2003. See in particular the calibration and reporting sections of this document.
2. *Lung Function Testing: Selection of Reference Values and Interpretive Results*, American Thoracic Society, March 1991. This document describes the methods of selecting the reference values and the algorithm for interpretative results.
3. *National Occupational Respiratory Mortality System*, National Institute for Occupational Safety and Health (NIOSH).
4. *Short Report Spirometric "Lung Age" Estimation for Motivating Smoking Cessation*, James F. Morris, M.D., and William Temple, *Preventive Medicine* 14, 655-662 (1985).
5. Standardisation of Spirometry, 2005 Update, ATS/ERS task force: This document describes the methods of acquiring the output parameters and the required accuracy. For details on ATS/ERS acceptability criteria, see these sections in the standard:
 - "Start of Test Criteria," page 324
 - "Manoeuvre repeatability," page 325
6. *Standardized Lung Function Testing*, *European Respiratory Journal*, volume 6, supplement 16, March 1993.
7. *U.S. Pulmonary Function Standards for Cotton Dust Standard*, 29 CFR 1910.1043, Appendix D.
8. *Lung Function Testing: Selection of reference values and interpretive strategies*. American Thoracic Society, *American Review of Respiratory Disease*, 144:1202-1218 (1991).

Glossary

adult	Generally, 18 or older. Age limits vary with each norm.
ATS	American Thoracic Society. An organization that provides standards for spirometry common practice and equipment.
ATS acceptability criteria	<p>Applicable to FVC testing only. (1) Criteria ensuring that an individual effort started and ended satisfactorily (no leaks or coughs). (2) Criteria ensuring that the patient has made at least two efforts of the same kind (two FVC-pre or two FVC-post), and that these efforts are reproducible. For details, see document <i>Standardisation of Spirometry, 2005 Update, ATS/ERS task force</i>: This document describes the methods of acquiring the output parameters and the required accuracy. For details on ATS/ERS acceptability criteria, see these sections in the standard:</p> <ul style="list-style-type: none"> • “Start of Test Criteria,” page 324 • “Manoeuvre repeatability,” page 325
ATS interpretive results	<p>The software generates interpretive results as described in <i>Lung Function Testing: Selection of Reference Values and Interpretive Results, American Thoracic Society</i>, March 1991. This document describes the methods of selecting the reference values and the algorithm for interpretative results.</p>
baseline	See pre-test.
best effort	A measurement calculated from a set of efforts. The formula for calculating best effort is user selectable: (1) the single best effort or (2) a composite of best parameter values.
BF	Breathing frequency. See also MV and tidal breathing.
bronchospasm evaluation	See post-test.
BTPS	Body conditions, normal body temperature (37° C), ambient pressure, saturated with water vapor. The BTPS correction factor converts ambient conditions — temperature, humidity, and pressure — to BTPS.
composite norm value	A value that is filled in from another norm — a “composite norm source” — when the primary (selected) norm does not support a given parameter. Applicable only when composite norm values are enabled.
COPD	Chronic obstructive pulmonary disease. Characterized by airflow obstruction that is primarily caused by smoking. Examples include emphysema, chronic bronchitis, and asthmatic bronchitis.

curve	A graphical display of spirometry data. During SVC testing, only one curve type is available: volume/ time. During FVC testing, two curve types are available: volume/time and flow/volume.
effort	A single spirometry maneuver, for example, one blow. A single test comprises multiple efforts. See also best effort.
ERS	European Respiratory Society.
ERV	Expiratory reserve volume (in liters). The maximum volume that can be expired from the level of the functional residual capacity (FRC). See also tidal breathing.
extrapolation	The practice of applying a norm's formula to a patient who doesn't fit that norm's demographics. For example, if you were testing an 88-year-old man, and the primary (selected) norm were based on males 85 or younger, the predicted values would be extrapolated values.
FEF50/FIF50	The ratio of these two parameters. See FEF50 and FIF50.
FEF25	Forced expiratory flow (in L/s) at 25% of FVC.
FEF50	Forced expiratory flow (in L/s) at 50% of FVC.
FEF75	Forced expiratory flow (in L/s) at 75% of FVC.
FEF85	Forced expiratory flow (in L/s) at 85% of FVC.
FEF0.2-1.2	Forced expiratory flow average (in L/s) between 0.2 and 1.2 liters of FVC.
FEF25-75	Forced expiratory flow average (in L/s) during the middle half of FVC.
FEF75-85 ("late" FEF)	Forced expiratory flow average (in L/s) between 75% and 85% of FVC.
FET	Forced expiratory time (in seconds). The elapsed time from the beginning of expiration until a specified percentage of FVC.
FEV0.5	Forced expiratory volume (in liters) at 0.5 seconds.
FEV1	Forced expiratory volume (in liters) at 1 second. An important parameter because it reflects the severity of COPD.
FEV1/FEV6	The ratio of these two parameters. See FEV1 and FEV6.
FEV2	Forced expiratory volume (in liters) at 2 seconds.
FEV3	Forced expiratory volume (in liters) at 3 seconds.
FEV5	Forced expiratory volume (in liters) at 5 seconds.
FEV6	Forced expiratory volume (in liters) at 6 seconds.
FEV0.5%	FEV0.5 as % of FVC.
FEV1%	FEV1 as % of VC.
FEV2%	FEV2 as % of FVC.

FEV3%	FEV3 as % of FVC.
FEV5%	FEV5 as % of FVC.
FEV6%	FEV6 as % of FVC.
FEVt	Timed forced expiratory volume (in liters). Volume of air exhaled in the specified time during an FVC effort.
FIF50	Forced inspiratory flow (in L/s) at 50% of FIVC.
FIV1	FIV1 as % of FIVC.
FVC	Forced inspiratory vital capacity (in liters). The maximum volume of air that can be inspired during forced inspiration starting from full expiration.
FIVt	Timed forced inspiratory volume (in liters). Volume of air inhaled in the specified time (t).
flow	The speed at which air is inhaled or exhaled (in L/s).
flow/volume	A type of data curve available during FVC testing. The y axis represents flow (L/s); the x axis represents volume (liters).
flow loop	A flow/volume curve that includes inspiratory data (negative values on the y axis).
FRC	Functional residual capacity (in liters). Volume of air remaining in the lungs and airway at the average end-expiratory level.
FVC	Forced vital capacity. (1) A type of test in which patients inhale fully and exhale forcefully for as long as they can. The goal: to measure the volume and flow of air. May or may not include forced inhaling. When forced inhaling is included, it may be done either before or after exhaling. See also flow loop. (2) An important parameter (in liters): the maximum volume of air that can be delivered during forced expiration starting from full inspiration.
IC	Inspiratory capacity (in liters). The maximum volume of air that can be inhaled after a normal — unforced — exhalation. See also tidal breathing.
incentive screen	An animated screen that gives patients — usually children — a goal to achieve while exhaling.
IRV	Inspiratory reserve volume (in liters). The maximum volume that can be inspired from the average end-inspiratory level. See also tidal breathing.
LLN	Lower limit of normal. The lowest expected value for a spirometric parameter. The method of determining this value varies from norm to norm. LLN is displayed together with the predicted value.
loop	See flow loop.
lung age	A calculated value based on a patient's demographics and spirometric performance that gives a relative indication of the health of the subject's lungs. This value is used primarily to encourage smoking cessation. Lung age is not available for patients under 20 years of age.
maneuver	See effort.
MV	Minute volume (in liters). $MV = BF \times VT$. See also tidal breathing.
NIOSH	National Institute for Occupational Safety and Health (U.S.).

norm	A research-based spirometry data set with a specific profile for race, gender, age, and height. The software compares each patient's results with data in the primary (selected) norm, reporting the results as percentages of the predicted (normal) values.
normal	Consistent with norm data.
OSHA	Occupational Safety & Health Administration (U.S.).
parameter	A commonly defined attribute of a spirometric waveform (FVC, FEV1, and so on).
pediatric	Generally, under 18 years old. Age limits vary with each norm. Also, young children's lung sizes vary greatly. Norm values and interpretive results are not available for patients under 3 years of age.
PEF	Peak expiratory flow (in L/s). The largest expiratory flow achieved with a forced effort.
PIF	Peak inspiratory flow (in L/s). The largest inspiratory flow achieved with a forced effort.
post-medication test	A test that provides data to compare with pre-test data. Sometimes called post-Rx or post-BD (bronchodilator). A post-test must follow a pre-test within 24 hours. See also reversibility.
predictive curve	A curve that follows a set of predictive points.
predictive points	Key values from the selected norm and from composite norms (if enabled). Applicable for FVC tests only. For flow/volume curves, predictive values are PEF, FEF25, FEF50, FEF75, and FVC (all represented as points). For volume/time curves, predictive values are FEV1 (represented as a point) and FVC (represented as a horizontal line). If predictive points are enabled, all available predictive values appear on the screen and the printout.
pre-medication test	A test that provides a baseline for comparison with a post-test taken by the same patient. Sometimes called pre-Rx or pre-BD (bronchodilator). Pre-tests and post-tests are commonly used to evaluate the effectiveness of medication. See also reversibility.
reversibility	The percentage difference between pre-test and post-test data. This measurement indicates the effect of medication on lung function. Reversibility applies to each parameter separately.
SVC	Slow (relaxed) vital capacity. (1) A type of test in which patients breathe normally several times, then inhale maximally and exhale maximally, or vice versa. Sometimes SVC testing is used when forced breathing is impossible. The patient inhales and exhales as completely as possible, as in FVC testing, but the breathing is not forced. The goal of an SVC effort is to measure the volume of air inhaled and exhaled, not the air flow (speed). (2) An important parameter (in liters): the maximum volume of air exhaled from the point of maximum inhalation, or maximum volume of air inhaled from a point of maximum exhalation.
test	A set of efforts — the efforts of a given type can be a mixture of pre-medication and post-medication efforts.
Tex	Tidal breathing expiration time (in seconds). See also tidal breathing.
tidal breathing	Multiple breaths, normal breathing. May be used during FVC or SVC testing. After measuring tidal breathing for several seconds, the following parameters can be extrapolated: MV, VE, BF, and Tin/Tex. If you combine a VT measurement with a VC measurement, you can also calculate the ERV, IC, and IRV. For example, COPD patients have a higher ERV and a lower IC and IRV.
tidal volume	See VT.
tidal volume curve	A flow loop that includes all data from all breaths, tidal and forced.

T_{in}	Tidal breathing inspiration time (in seconds). See also tidal breathing.
T_{in}/T_{ex}	The ratio of T _{in} and T _{ex} . See also T _{in} and T _{ex} .
TV	See VT.
variance	The difference between the best and worst efforts for a parameter (FEV ₁ , FVC, and so on). Pre-test and post-test variances are reported separately. See also best effort.
VC	Vital capacity. See FVC or SVC.
VE	Ventilation in L/min. See also tidal breathing.
vital capacity	See FVC or SVC.
volume = f(t)	See volume/time.
volume/time	Same as volume over time or volume = f(t). A type of data curve available during both FVC and SVC testing. The y axis represents liters; the x axis represents seconds.
VT	Tidal volume (in liters). Also called TV, although VT is the preferred abbreviation. The volume of air that enters the lungs during inspiration and leaves the lungs during expiration in a normal breathing cycle. One of the most important parameters in SVC testing. See also MV, tidal breathing, and tidal volume curve.
z	A dimensionless value that indicates how many standard deviations a measurement is away from the predicted value. For example, z = -1 means that the measured parameter value is one standard deviation below the predicted value. The z-score will be shown together with the % predicted values for the norms that support z-score calculation.

Appendix

Approved accessories

The following tables list approved spirometry accessories and documentation. For information about options, upgrades, and licenses, refer to the service manual.

Options and software upgrades

Part Number	Description
406814	CP 50/150 connectivity kit

Components of the CP 150 Spirometry Option

Part Number	Description
410027	Spirometry kit, CP150
410370	Spirometry pressure tube and handle kit, CP150
105660	Upgrade kit spirometry, CP150
720705	GEN4, Disposable flow transducers, CP150 (pack of 25)
720706	GEN4 Disposable flow transducers, CP150 (pack of 100)
720707	Spirometry pressure tubing , CP150 (2 meters)
100680	Nose clip (pack of 25)
26004-0000	Germicidal Sani-Cloth® canister
410024	Spirometry bracket (contains 2 thumbscrews)
105353	CP100/200/150 ECG Chart Paper (200 sheets/pack, 5 packs/case)

USB cable

Part Number	Description
CP150-0027	Service Kit, USB cable

ECG Cart

Part Number	Description
105341	CP150 Office cart (cable arm and shelf sold separately)
105342	CP150 Hospital cart (cable arm and shelf sold separately)
105343	CP150 Cable arm and shelf cart option (compatible with the CP150 office and hospital carts)

Literature/Documentation

Part Number	Description
106584	Kit, CD, User Documentation, CP 150 Spirometry Option
106583	Directions for Use, Printed Copy, English
106582	Quick Reference Guide, Printed Copy, English
105752	Startup Guide, Printed Copy
71038-3000	Spirometry Reference Chart, Poster
703337	Spirometry Effort Acceptability, Poster

Calibration syringe

Part Number	Description
703480	Calibration syringe (3 L)
BASIC-LVL-CAL	Exchange calibration syringe
BASIC-LVL2-CAL	Syringe, calibration and return service

WelchAllyn®

Advancing Frontline Care™

Material No.

728648

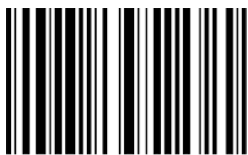

(91)728648