

Welch Allyn®

H3+™

DIGITAL HOLTER RECORDER
SERVICE MANUAL

Manufactured by Welch Allyn, Inc., Skaneateles Falls, NY U.S.A.



CAUTION: Federal law restricts this device to sale by or on the order of a physician.

© 2019 Welch Allyn This document contains confidential information that belongs to Welch Allyn, Inc. No part of this document may be transmitted, reproduced, used, or disclosed outside of the receiving organization without the express written consent of Welch Allyn, Inc. Welch Allyn is a registered trademark of Welch Allyn, Inc. H3+ is a trademark of Welch Allyn, Inc.

For patent information, please visit www.welchallyn.com/patents

For information about any Welch Allyn product, visit: <https://www.welchallyn.com/en/about-us/locations.html>

Customer Service and Technical Support: <https://www.welchallyn.com/en/other/contact-us.html> 1.888.667.8272,
mor_tech.support@hillrom.com



9516-165-50-ENG Rev L (also refer to TDR pages when making revision changes)

Revision Date: 2023-08



901142 HOLTER RECORDER



Welch Allyn, Inc.
4341 State Street Road
Skaneateles Falls, NY 13153 USA

www.welchallyn.com

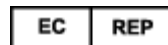

EU IMPORTER

Welch Allyn Limited
Navan Business Park, Dublin Road,
Navan, Co. Meath C15 AW22
Ireland

TABLE OF CONTENTS

NOTICES	3
MANUFACTURER’S RESPONSIBILITY.....	3
RESPONSIBILITY OF THE CUSTOMER.....	3
EQUIPMENT IDENTIFICATION	3
COPYRIGHT AND TRADEMARK NOTICES	3
OTHER IMPORTANT INFORMATION	3
NOTICE TO EU USERS AND/OR PATIENTS.....	3
WARRANTY INFORMATION	4
YOUR WELCH ALLYN WARRANTY	4
USER SAFETY INFORMATION	5
WARNING(S).....	5
CAUTION(S)	6
NOTE(S)	6
EQUIPMENT SYMBOLS AND MARKINGS	8
SYMBOL DELINEATION	8
ELECTROMAGNETIC COMPATIBILITY(EMC)	9
GENERAL	13
SERVICE MANUAL PURPOSE	13
PERIODIC SAFETY INSPECTIONS	13
PROPER PATIENT CABLE	13
RECOMMENDED ACCESSORIES	13
STERILIZING THIS PRODUCT	13
LIQUID SPILLS	13
PRODUCT INFORMATION	13
DISPOSAL	13
MAINTENANCE AND CLEANING	14
INTRODUCTION.....	14
RECOMMENDED CLEANING SUPPLIES	14
CLEANING AND INSPECTING TECHNIQUES.....	14
METALLIC AND PLASTIC PARTS CLEANING	14
EXTERIOR CLEANING	14
INTERIOR VISUAL INSPECTION	15
PREVENTATIVE MAINTENANCE SCHEDULE	15
BATTERY REMOVAL/INSTALLATION	15
TECHNICAL DESCRIPTION	17
H3+ OVERVIEW.....	17
H3+ SPECIFICATIONS	19
DISASSEMBLY	20
PARTS LIST.....	20
OPENING THE UNIT	21

INSERTING THE BATTERY	22
ATTACHING THE PATIENT CABLE.....	23
ATTACHING THE USB DOWNLOAD CABLE	24
COVER REMOVAL	25
KEYPAD REMOVAL.....	26
BOARD REMOVAL.....	27
LCD REMOVAL	28
BOARD SEPARATION	29
PRINTED CIRCUIT BOARDS	30
INTRODUCTION	30
BLOCK DIAGRAM.....	30
H3+ FRONT END PC BOARD	31
H3+ DIGITAL PC BOARD	32
TROUBLESHOOTING	33
INTRODUCTION	33
DEVICE LOG FILES.....	34
CONFORMANCE TESTING.....	37
INTRODUCTION	37

NOTICES

Manufacturer's Responsibility

Welch Allyn, Inc. is responsible for the effects on safety and performance only if:

- Assembly operations, extensions, readjustments, modifications, or repairs are carried out only by persons authorized by Welch Allyn, Inc.
- The device (H3+) is used in accordance with the instructions for use.

Responsibility of the Customer

The user of this device is responsible for ensuring the implementation of a satisfactory maintenance schedule. Failure to do so may cause undue failure and possible health hazards.

Equipment Identification

Welch Allyn, Inc. equipment is identified by a serial and reference number on the back of the device. Care should be taken so that these numbers are not defaced.

Copyright and Trademark Notices

This document contains information that is protected by copyright. All rights are reserved. No part of this document may be photocopied, reproduced, or translated to another language without prior written consent of Welch Allyn, Inc.

Other Important Information

The information in this document is subject to change without notice.

Welch Allyn, Inc. makes no warranty of any kind with regard to this material including, but not limited to, implied warranties of merchantability and fitness for a particular purpose. Welch Allyn, Inc. assumes no responsibility for any errors or omissions that may appear in this document. Welch Allyn, Inc. makes no commitment to update or to keep current the information contained in this document.

Notice to EU Users and/or Patients

Any serious incident that has occurred in relation to the device, should be reported to the manufacturer and the competent authority of the Member State in which the user and/or patient is established.

WARRANTY INFORMATION

Your Welch Allyn Warranty

WELCH ALLYN, INC. (hereafter referred to as “Welch Allyn”) warrants that components within Welch Allyn products (hereafter referred to as “Product/s”) will be free from defects in workmanship and materials for the number of years specified on documentation accompanying the product, or previously agreed to by the purchaser and Welch Allyn, or if not otherwise noted, for a period of twenty-four (24) months from the date of shipment.

Consumable, disposable or single use products such as, but not limited to, PAPER or ELECTRODES are warranted to be free from defects in workmanship and materials for a period of 90 days from the date of shipment or the date of first use, whichever is sooner.

Reusable product such as, but not limited to, BATTERIES, BLOOD PRESSURE CUFFS, BLOOD PRESSURE HOSES, TRANSDUCER CABLES, Y-CABLES, PATIENT CABLES, LEAD WIRES, MAGNETIC STORAGE MEDIUMS, CARRY CASES or MOUNTS, are warranted to be free from defects in workmanship and materials for a period of 90 days. This warranty does not apply to damage to the Product/s caused by any or all of the following circumstances or conditions:

- a) Freight damage;
- b) Parts and/or accessories of the Product/s not obtained from or approved by Welch Allyn;
- c) Misapplication, misuse, abuse, and/or failure to follow the Product/s instruction sheets and/or information guides;
- d) Accident; a disaster affecting the Product/s;
- e) Alterations and/or modifications to the Product/s not authorized by Welch Allyn;
- f) Other events outside of Welch Allyn’s reasonable control or not arising under normal operating conditions.

THE REMEDY UNDER THIS WARRANTY IS LIMITED TO THE REPAIR OR REPLACEMENT WITHOUT CHARGE FOR LABOR OR MATERIALS, OR ANY PRODUCT/S FOUND UPON EXAMINATION BY WELCH ALLYN TO HAVE BEEN DEFECTIVE. This remedy shall be conditioned upon receipt of notice by Welch Allyn of any alleged defects promptly after discovery thereof within the warranty period. Welch Allyn’s obligations under the foregoing warranty will further be conditioned upon the assumption by the purchaser of the Product/s (i) of all carrier charges with respect to any Product/s returned to Welch Allyn’s principal place or any other place as specifically designated by Welch Allyn or an authorized distributor or representative of Welch Allyn, and (ii) all risk of loss in transit. It is expressly agreed that the liability of Welch Allyn is limited and that Welch Allyn does not function as an insurer. A purchaser of a Product/s, by its acceptance and purchase thereof, acknowledges and agrees that Welch Allyn is not liable for loss, harm, or damage due directly or indirectly to an occurrence or consequence therefrom relating to the Product/s. If Welch Allyn should be found liable to anyone under any theory (except the expressed warranty set forth herein) for loss, harm, or damage, the liability of Welch Allyn shall be limited to the lesser of the actual loss, harm, or damage, or the original purchase price of the Product/s when sold.

EXCEPT AS SET FORTH HEREIN WITH RESPECT TO REIMBURSEMENT OF LABOR CHARGES, A PURCHASER’S SOLE EXCLUSIVE REMEDY AGAINST WELCH ALLYN FOR CLAIMS RELATING TO THE PRODUCT/S FOR ANY AND ALL LOSSES AND DAMAGES RESULTING FROM ANY CAUSE SHALL BE THE REPAIR OR REPLACEMENT OF DEFECTIVE PRODUCT/S TO THE EXTENT THAT THE DEFECT IS NOTICED AND WELCH ALLYN IS NOTIFIED WITHIN THE WARRANTY PERIOD. IN NO EVENT, INCLUDING THE CLAIM FOR NEGLIGENCE, SHALL WELCH ALLYN BE LIABLE FOR INCIDENTAL, SPECIAL, OR CONSEQUENTIAL DAMAGES, OR FOR ANY OTHER LOSS, DAMAGE, OR EXPENSE OF ANY KIND, INCLUDING LOSS OF PROFITS, WHETHER UNDER TORT, NEGLIGENCE OR STRICT LIABILITY THEORIES OF LAW, OR OTHERWISE. THIS WARRANTY IS EXPRESSLY IN LIEU OF ANY OTHER WARRANTIES, EXPRESS OR IMPLIED, INCLUDING, BUT NOT LIMITED TO THE IMPLIED WARRANTY OF MERCHANTABILITY AND THE WARRANTY OF FITNESS FOR A PARTICULAR PURPOSE.

USER SAFETY INFORMATION



WARNING:

Means there is the possibility of personal injury to you or others.



Caution:

Means there is the possibility of damage to the device.

Note:

Provides information to further assist in the use of the device.

***NOTE:** This manual may contain screen shots and pictures. Any screen shots and pictures are provided for reference only and are not intended to convey actual operating techniques. Consult the actual screen in the host language for specific wording.*



WARNING(S)

- Device (H3+) stores data reflecting a patient's physiological condition and can be downloaded to a properly equipped analysis system. The data, when reviewed by a trained physician or clinician, can be useful in determining a diagnosis. However, the data should not be used as a sole means for determining a patient's diagnosis.
- To maintain designed operator and patient safety, peripheral equipment and accessories that can come in direct patient contact must be in compliance with UL 2601-1, IEC 601-1 and IEC 601-2-47.
- To maintain designed operator and patient safety, only use parts and accessories supplied with the device and available through Welch Allyn, Inc.
- To avoid the possibility of serious injury or death, do not come in contact with the device or patient cable during patient defibrillation. Additionally, proper placement of defibrillator paddles in relation to the electrodes is required to minimize harm to the patient.
- A possible explosion hazard does exist; therefore do not use the device in the presence of flammable anesthetics.
- Defibrillation protection is guaranteed only if a Welch Allyn, Inc. Patient Cable is used.
- Simultaneous connection to other equipment may increase leakage current.
- ECG electrodes could cause skin irritation and should be examined daily. It may be necessary to replace electrodes if signs of irritation or inflammation occur.
- Before attempting to use the device for clinical applications, the operator must read and understand the contents of the User Manual and any documents accompanying the device.

 **Caution(s)**

- To prevent possible damage to the Enter button, do not use sharp or hard objects to depress the button; use fingertips only.
- Do not attempt to clean the device or patient cable by submerging into a liquid, autoclaving or steam cleaning.
- Wipe the exterior surface of the device with a sterilizing disinfectant; then dry with a clean cloth.
- Conductive parts of the patient cable, electrodes and associated Type CF connections, including the neutral conductor of the patient cable and electrode, should not come into contact with other conductive parts, including earth ground.
- The device and patient cable should be cleaned after each use.
- Do not pull or stretch patient cables since this could result in mechanical and/or electrical failures. Patient cables should be stored after forming them into a loose loop.
- No user serviceable parts are inside. Any modification to any part of this device is to be performed by Welch Allyn, Inc. service personnel only. Any unauthorized modification of this device may alter defibrillation protection.
- Environmental Conditions:
 - Operating Temperature: 0° to +45° C
 - Storage Temperature: -20° to +65° C
 - Relative Humidity: 5 to 95%, non-condensing
 - Ambient Air Pressure: 700 to 1060 millibars

Note(s)

- Proper patient preparation is important prior to proper application of ECG electrodes and operation of the device.
- Patient cables should be checked for cracks or breakage prior to use.
- Complete lead fail will cause a greater draw on battery power which may cause the recording period to end early due to low battery voltage.
- As defined by IEC 60601-1 and IEC 60601-2-47, this device is classified as follows:
 - Internally powered
 - Type CF defibrillator proof applied parts
 - Ordinary equipment
 - Not suitable for use in the presence of flammable anesthetics
 - Continuous operation.

- The device conforms to the following standards:

IEC 601-1	General Requirements for Safety
IEC 601-2-47	Particular Requirements for Safety, including Essential Performance
IEC 601-1-2	Electromagnetic Compatibility
ANSI/AAMI EC38	Ambulatory Electrocardiographs
93/42/EEC	Medical Device Directive

- The device is UL classified:



WITH RESPECT TO ELECTRIC SHOCK,
FIRE AND MECHANICAL HAZARDS ONLY IN ACCORDANCE WITH
IEC 60601-1, CAN/CSA C22.2 No. 60601-1,
AND IEC 60601-2-47

EQUIPMENT SYMBOLS AND MARKINGS

Symbol Delineation



CAUTION The caution statements in this manual identify conditions or practices that could result in damage to the equipment or other property, or loss of data.



WARNING The warning statements in this manual identify conditions or practices that could lead to illness, injury, or death. In addition, when used on a patient applied part, this symbol indicates defibrillation protection is in the cables. Warning symbols will appear with a grey background in a black and white document.



Defibrillator-proof type CF applied part



Battery



Indicates compliance to applicable European Union directives



Do not dispose as unsorted municipal waste. Requires separate handling for waste disposal according to local requirements



Follow instructions/directions for use (DFU) – mandatory action. A copy of the DFU is available on this website. A printed copy of the DFU can be ordered from Welch Allyn for delivery within 7 calendar days.



Medical Device



Model Identifier



Reorder Number

ELECTROMAGNETIC COMPATIBILITY (EMC)

Electromagnetic compatibility with surrounding devices should be assessed when using the device.

An electronic device can either generate or receive electromagnetic interference. Testing for electromagnetic compatibility (EMC) has been performed on the device according to the international standard for EMC for medical devices (IEC 60601-1-2). This IEC standard has been adopted in Europe as the European Norm (EN 60601-1-2).

The device should not be used adjacent to, or stacked on top of other equipment. If the device must be used adjacent to or stacked on top of other equipment, verify that the device operates in an acceptable manner in the configuration in which it will be used.

Fixed, portable, and mobile radio frequency communications equipment can affect the performance of medical equipment. See the appropriate EMC table for recommended separation distances between the radio equipment and the device.

The use of accessories, transducers, and cables other than those specified by Welch Allyn may result in increased emissions or decreased immunity of the equipment.

Guidance and Manufacturer's Declaration: Electromagnetic Emissions

The equipment is intended for use in the electromagnetic environment specified in the table below. The customer or the user of the equipment should ensure that it is used in such an environment.

Emissions Test	Compliance	Electromagnetic Environment: Guidance
RF Emissions CISPR 11	Group 1	The equipment uses RF energy only for its internal function. Therefore, its RF emissions are very low and not likely to cause any interference in nearby electronic equipment. The equipment is suitable for use in all establishments, including domestic establishments and those directly connected to the public low-voltage power supply network that supplies buildings used for domestic purposes.
RF Emissions CISPR 11	Class B	
Harmonic Emissions IEC 61000-3-2	Not Applicable	
Voltage Fluctuations/ Flicker Emissions IEC 61000-3-3	Not Applicable	

Guidance and Manufacturer's Declaration: Electromagnetic Immunity

The equipment is intended for use in the electromagnetic environment specified in the table below. The customer or the user of the equipment should ensure that it is used in such an environment.

Emissions Test	Compliance	Compliance Level	Electromagnetic Environment: Guidance
Electrostatic discharge (ESD) IEC 61000-4-2	+/- 6 kV contact +/- 8 kV air	+/- 6 kV contact +/- 8 kV air	Floors should be wood, concrete, or ceramic tile. If floors are covered with synthetic material, the relative humidity should be at least 30%.
Electrical fast transient/burst IEC 61000-4-4	+/- 2 kV for power supply lines +/- 1 kV for input/output lines	Not Applicable	
Surge IEC 61000-4-5	+/- 1 kV differential mode +/- 2 kV common mode	Not Applicable	
Voltage dips, short interruptions, and voltage variations on power supply input lines IEC 61000-4-11	<5% UT (>95% dip in UT) for 0.5 cycle 40% UT (60% dip in UT) for 5 cycles	Not Applicable	
Power frequency (50/60 Hz) magnetic field	3 A/m	3 A/m	Power frequency magnetic fields should be at levels characteristic of a typical location in a typical commercial or hospital environment.

NOTE: UT is the AC Mains voltage prior to application of the test level.

Guidance and Manufacturer's Declaration: Electromagnetic Immunity

The equipment is intended for use in the electromagnetic environment specified in the table below. The customer or the user of the equipment should ensure that it is used in such an environment.

Emissions Test	IEC 60601 Test Level	Compliance Level	Electromagnetic Environment: Guidance
Conducted RF IEC 61000-4-6	3 Vrms 150 kHz to 80 MHz	3 Vrms 150 kHz to 80 MHz	<p>Portable and mobile RF communications equipment should be used no closer to any part of the equipment, including cables, than the recommended separation distance calculated from the equation applicable to the frequency of the transmitter.</p> <p>Recommended separation distance</p> $d = \left[\frac{3.5}{3V_{rms}} \right] \sqrt{P}$ $d = \left[\frac{3.5}{3V/m} \right] \sqrt{P} \quad 80 \text{ MHz to } 800 \text{ MHz}$ $d = \left[\frac{7}{3V/m} \right] \sqrt{P} \quad 800 \text{ MHz to } 2.5 \text{ GHz}$ <p>Where P is the maximum output power rating of the transmitter in watts (W) according to the transmitter manufacturer and d is the recommended separation distance in meters (m).</p> <p>Field strengths from fixed RF transmitters, as determined by an electromagnetic site survey^a, should be less than the compliance level in each frequency range^b.</p> <p>Interference may occur in the vicinity of equipment marked with the following symbol:</p> 
Radiated RF IEC 61000-4-3	3 Vrms 80 MHz to 2.5 GHz	3 Vrms 80 MHz to 2.5 GHz	

- a. Field strengths from fixed transmitters, such as base stations for radio (cellular/cordless) telephones and land mobile radios, amateur radios, AM and FM radio broadcast, and TV broadcast cannot be predicted theoretically with accuracy. To assess the electromagnetic environment due to fixed RF transmitters, an electromagnetic site survey should be considered. If the measured field strength in the location in which the equipment is used exceeds the applicable RF compliance level above, the equipment should be observed to verify normal operation. If abnormal performance is observed, additional measures may be necessary, such as reorienting or relocating the equipment.
- b. Over the frequency range 150 kHz to 80 MHz, field strengths should be less than [3] V/m.

Recommended Separation Distances Between Portable and Mobile RF Communications Equipment and the Equipment

The equipment is intended for use in the electromagnetic environment in which radiated RF disturbances are controlled. The customer or the user of the equipment can help to prevent electromagnetic interference by maintaining a minimum distance between portable and mobile RF communications equipment (transmitters) and the equipment as recommended in the table below, according to the maximum output power of the communications equipment.

Rated Maximum Output Power of Transmitter W	Separation Distance According to Frequency of Transmitter (m)	
	150 KHz to 800 MHz	800 MHz to 2.5 GHz
	$d = 1.2\sqrt{P}$	$d = 2.3\sqrt{P}$
0.01	0.1 m	0.2 m
0.1	0.4 m	0.7 m
1	1.2 m	2.3 m
10	4.0 m	7.0 m
100	12.0 m	23.0 m

For transmitters rated at a maximum output power not listed above, the recommended separation distance d in meters (m) can be estimated using the equation applicable to the frequency of the transmitter, where P is the maximum output power rating of the transmitter in watts (W) according to the transmitter manufacturer.

NOTE 1: At 800 MHz, the separation distance for the higher frequency range applies.

NOTE 2: These guidelines may not apply in all situations. Electromagnetic propagation is affected by the absorption and reflection from structures, objects, and people.

GENERAL CARE

Service Manual Purpose

The purpose of this manual is to provide information to authorized service personnel to maintain and repair the H3+ Holter Recorder.



WARNING: *No user serviceable parts are inside. Any modification of this device will void Manufacturer's Warranties and/or responsibilities. If you are not able to correct the H3+ Holter Recorder's operation using the Troubleshooting guide in the Operator's Manual, contact an authorized Welch Allyn service representative for repair assistance.*

Periodic Safety Inspections

Follow the recommended maintenance schedule. Inspect the patient cable(s) periodically for fraying or other damage and replace as needed. Broken or frayed wires may cause interference or loss of signal. Pay particular attention to points where wires enter connectors.

Proper Patient Cable

Use only the patient cable specified for this unit.

Recommended Accessories

For the patient's safety and optimum equipment performance, use only the accessories specified by/or that meet Welch Allyn, Inc. specifications.

Sterilizing this Product

Do not sterilize this product or any accessories unless specifically directed by the manufacturer. Sterilization and sterilization environments can seriously damage many components and accessories.

Liquid Spills

Do not set beverages or other liquids on or near the H3+, and/or optional equipment.

Product Information

See the Technical Description section of this manual.

Disposal

This product and its accessories must be disposed of according to local laws and regulations. Do not dispose of this product as unsorted municipal waste. For more specific disposal information see www.welchallyn.com/weee.

MAINTENANCE AND CLEANING

Introduction

This section provides maintenance and cleaning instructions for the H3+ Holter Recorder.

Recommended Cleaning Supplies



- Anti-static mat & wrist band, properly grounded
- Clean, lint-free cloth
- Hospital grade germicidal solution
- DRY, low pressure, compressed air (30 psi)

NOTE: The equipment and solvent mentioned above are standard shop commodities that are available from commercial sources.

Cleaning and Inspecting Techniques

This section contains instructions for periodic cleaning and inspection of the instrument as preventative maintenance measures. It also contains specific cleaning procedures to be conducted. Parts having identical cleaning procedures are grouped under common headings. No special tools are required.



WARNING
Ventilate work area thoroughly when using solvents. Observe manufacturers warnings on solvent containers with regard to personnel safety and emergency first aid. Be sure that first aid equipment is available before using chemicals. Observe shop safety and fire precautions. Ventilate all work areas where solvents are used. Store solvents and solvent-soaked rags in approved containers. Refer to manufacturers' instructions on containers for recommended fire-fighting procedures, and make sure that fire-fighting equipment is available.

Metallic and Plastic Parts Cleaning



CAUTION
Do not wipe over surfaces of nameplates or labels with abrasive cleaners or materials, as this will eventually wear away the nameplate information. Do not use solvents to clean plastic parts.

Exterior Cleaning

Use a cloth with a hospital grade germicidal or a 10% bleach solution (1 part bleach, 9 parts water) to clean the external housing and the patient cable.

Interior Visual Inspection

Check all connectors for loose, bent or corroded contact points

Check wire, harnesses and cables for signs of wear or deterioration.

Inspect leads for security of mounting, or deterioration.

Check terminals and connections for proper installation, loss or wear.

Inspect chassis and covers for warping, bending, surface damage or missing captive hardware.

Check for any other form of mechanical damage, which may indicate a failure.

Preventative Maintenance Schedule

Maintenance to be Performed	Period	Notes
Clean and inspect unit.	6 mo.	Perform every 3 mo. if unit is in heavy use.
Replace Battery Door	2 yrs	May become loose over time, dependent upon use

Battery Removal/Installation

Remove the battery door.



Remove the Battery.



Check battery connection terminals for debris and/or corrosion.



CAUTION

*Be sure that the polarity of the battery is correct.
Use only Welch Allyn approved Alkaline replacement battery (Welch Allyn part #4800-009).*

Install the battery.

TECHNICAL DESCRIPTION

H3+ Overview

System Description

The H3+ Digital Recorder, software version V3.0.0 or newer provides three channels of continuous ECG data recorded over an extended period of time. An LCD screen and Enter button allow for checking the lead quality during patient hook-up and starting the recording.

The H3+ Digital Recorder prior to V3.0.0 has the option to use either a 2 or 3 channel patient cable. The 2 channel, 5 wire patient cable records ECGs for up to 48 hours and displays Channel 1 and Channel 2 during patient hook up. The 3-Channel 5-wire patient cable records 24 hours of data and displays ECG leads I, II and V during patient hook-up.

During recording, the LCD will display R and the time of day as HH:MM:SS indicating that the H3+ is in the recording mode. The Enter button can be used to enter event markers in the patient record.

The H3+ Digital Recorder uses a single AAA alkaline battery and stores acquired ECG data in internal memory. The recorded data will remain in memory until it has been cleared by the clinician.

Stored ECG data will be downloaded for analysis to the H-Scribe Holter Analysis System with a USB interface cable after the H3+ has been disconnected from the patient cable. After the data is downloaded, the memory can then be cleared and the H3+ is ready for use on the next patient.

H3+ Digital Recorder Diagram

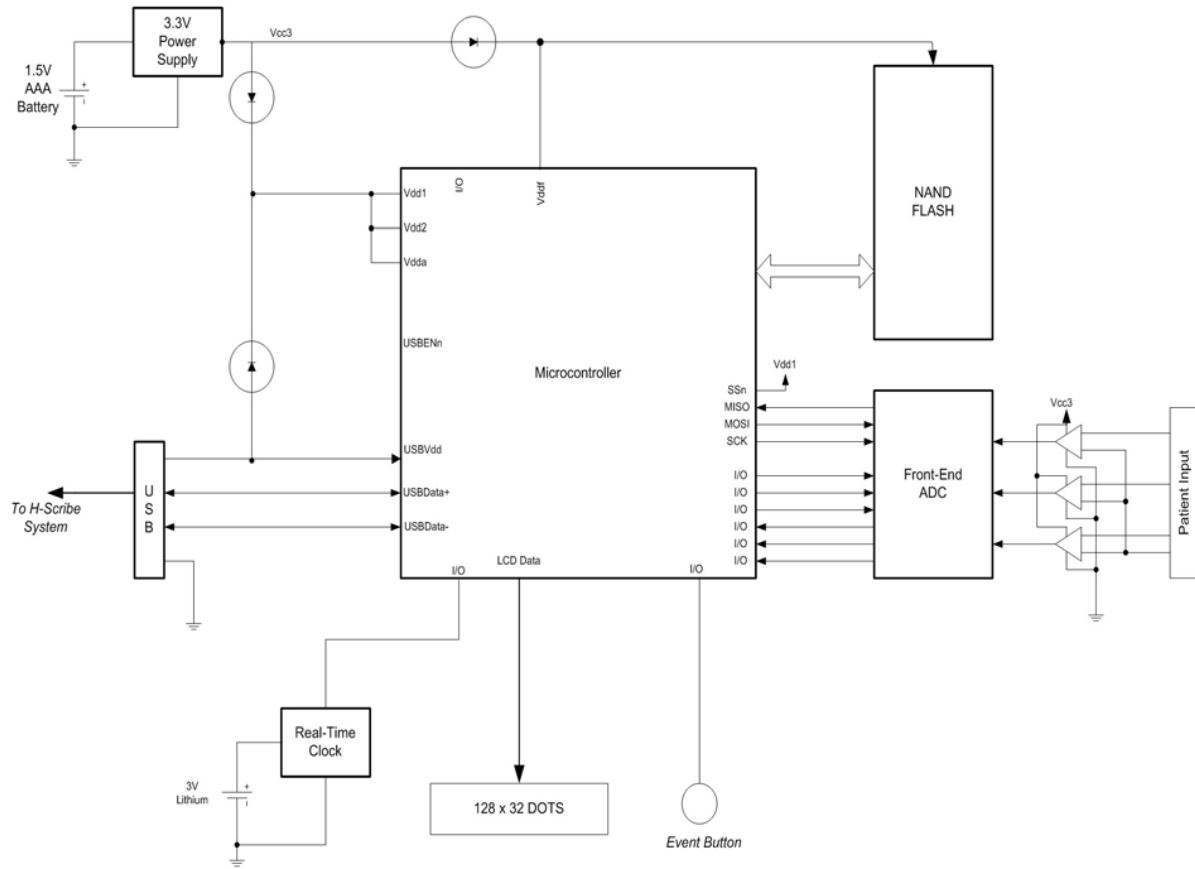

H3+ Specifications

FEATURE	Specifications
INSTRUMENT TYPE	Digital Holter Recorder
INPUT CHANNELS	<ul style="list-style-type: none"> • V3.0.0- Simultaneous acquisition of three channels • Prior to V3.0.0- Simultaneous acquisition of two or three channels
LEADS ACQUIRED	<ul style="list-style-type: none"> • V3.0.0- Modified I, II, III, aVR, aVL, aVF and V Prior to V3.0.0- Modified I, II and V or Bipolar Channel 1 and Channel 2
INPUT IMPEDANCE INPUT DYNAMIC ELECTRODE OFFSET TOLERANCE FREQUENCY RESPONSE	<ul style="list-style-type: none"> • V3.0.0- Meet or exceed the requirements of IEC 60601-2-47 • Prior to V3.0.0- Meet or exceed the requirements of ANSI/AAMI EC38
DIGITAL SAMPLING RATE	180 s/sec/channel used for standard recording and storage.
SPECIAL FUNCTIONS	Pacemaker Detection, ECG Display during hookup
A/D CONVERSION	12-bit
STORAGE	<ul style="list-style-type: none"> • V3.0.0- Internal, non-volatile memory. Prior to V3.0.0- Internal, non-volatile memory up to 48 hr
DEVICE CLASSIFICATION	Type CF defibrillator proof applied parts, internally powered
WEIGHT	1 Ounce (28 g) without battery
DIMENSIONS	2.5 x 1.0 x .75 inches (64 x 25 x 19 mm)
BATTERIES	1 AAA Alkaline Required

DISASSEMBLY



WARNING: No user serviceable parts are inside. Any modification of this device will void Manufacturer's Warranties and/or responsibilities. If you are not able to correct the H3+ Holter Recorder's operation using the Troubleshooting guide in the Operator's Manual, contact an authorized Welch Allyn service representative for repair assistance.

Parts List

H3+ Digital Recorder Assembly

Item Number	Part Number:	Description:	Qty:
1	*36025-139-153	H3+ Digital PCB Assembly – TESTED (V3.x.x SW only)	1
	*compatible with PN: 76165-001-70/71 (H3+ core with cool grey plastic)		
	**26025-058-150	H3+ Digital PCB Assembly (V2.xx SW only)	1
	**compatible only with PN: 76165-001-50 (H3+ core with white plastic)		
2	26025-060-150	H3+ Front End PCB Assembly	1
3	4160-030-50	Keypad Assembly H3+	1
	774585	KEYPAD ASSEMBLY H3+ V2	1
4	774398	LCD MODULE CHIP ON GLASS 128x32	1
5	8348-001-50	H3+ Upper Housing Assembly (white plastic)	1
	8348-001-70	H3+ UPPER HOUSING ASSEMBLY CG1C	1
6	8348-002-50	H3+ Lower Housing Assembly (white plastic)	1
	8348-002-70	H3+ LOWER HOUSING CG1C	1
	774586	H3+ LOWER HOUSING RECESSED	1
7	8348-003-50	H3+ Door Assembly (white plastic)	1
	8348-003-70	H3+ DOOR CG1C	1
8	8348-004-50	H3+ LCD Bezel (white plastic)	1
	8348-004-70	H3+ LCD BEZEL CG1C	1
9	9042-047-01	LABEL BACK H3+ (white plastic)	1
	9042-047-02	LABEL BACK H3+ INMETRO (Mortara)	1
	77315	LABEL BACK H3+ INMETRO (Welch Allyn)	1
	9042-047-03	LABEL BACK H3+ CG1C (Mortara)	1
	749225	LABEL BACK H3+ CG1C (Welch Allyn)	1
10	25019-006-60	CABLE H3+ USB DOWNLOAD GRAY	1

Opening the Unit



Anti-Static equipment should always be worn when working with static sensitive devices and in a static sensitive area.

Opening and Closing the Battery Door

Pictures shown are of the latest Welch Allyn H3+ design. Parts should be ordered based on the model being serviced. Please ensure that the appropriate parts are ordered based on your model color and function (cool grey model shown below).

Locate the battery door, Item 7, on the unit.



Press down slightly and slide the door off the unit until it stops.



Lift battery door to access the battery compartment.



Inserting the Battery

The H3+ Recorder is powered with a single AAA alkaline battery.

To insert a new battery into the battery compartment, open the battery door of the H3+. If a battery is present in the compartment, remove and discard the battery. Insert a new battery, observing proper polarity. Close the battery door of the recorder.

NOTE: The H3+ recorder requires a fully-charged battery to record a monitoring session. If you are not clear as to the status of a battery's voltage, use a new battery to insure operation for the monitoring session.



Attaching the Patient Cable

The patient cable attaches to the unit by sliding onto the input connector of the H3+. Each leadwire terminates in a snap connector.



H3+ Patient Cable

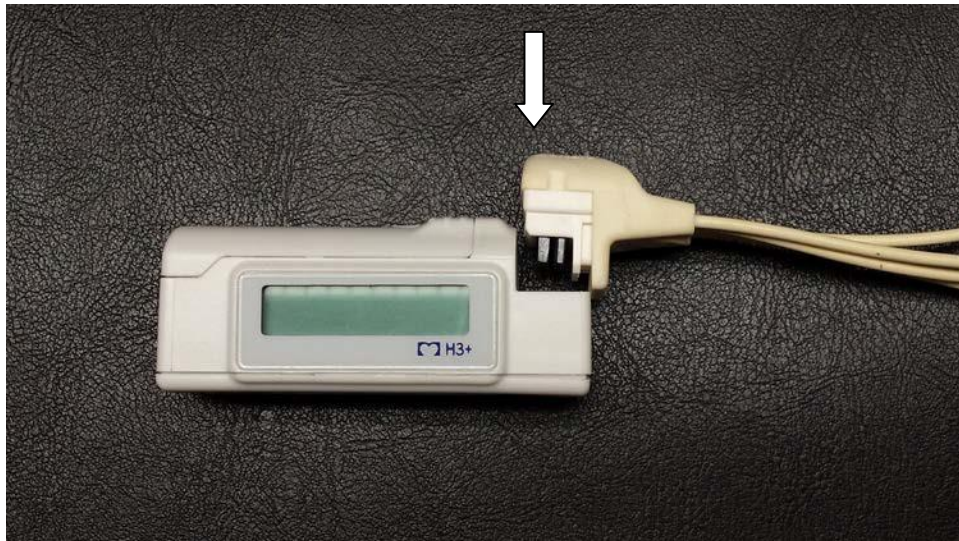

Attaching the USB Download Cable

The USB download cable uses the same connector as the patient cable does.

Remove the patient cable from the H3+.

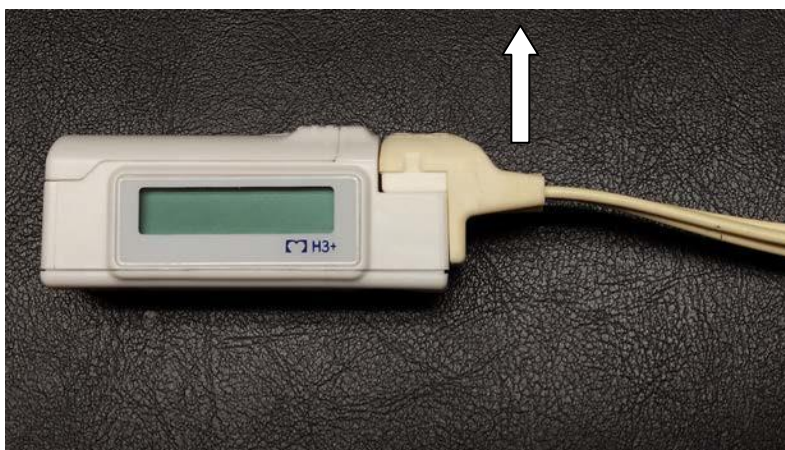

The USB download cable, item 10, attaches to the unit much like the patient cable, sliding onto the input connector of the H3+.

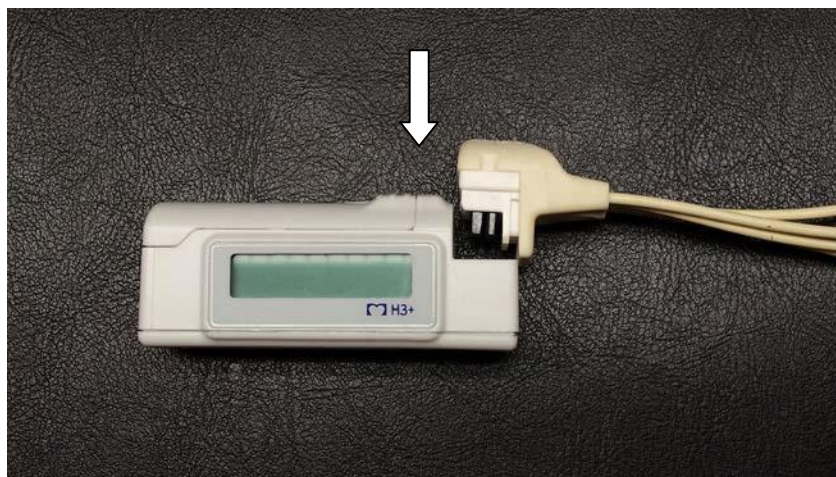

For specifics on downloading the data from the H3+ to a computer please see the H-Scribe user manual.

Cover Removal

NOTE: Some units may be glued together making opening of the unit a destructive process. Inspect the cover to make sure that the cover is not glued to the case. If the cover is glued to the case please contact Welch Allyn Technical Support Group for details about repair.

NOTE: Open the battery door and remove the battery prior to opening the unit.

Locate the locking tab on the side of the unit.



Insert a flat blade screwdriver into this slot and gently push in to release the Lower Housing, item 6.



Remove the Lower Housing, item 6, from the unit by rotating and lifting the cover off.

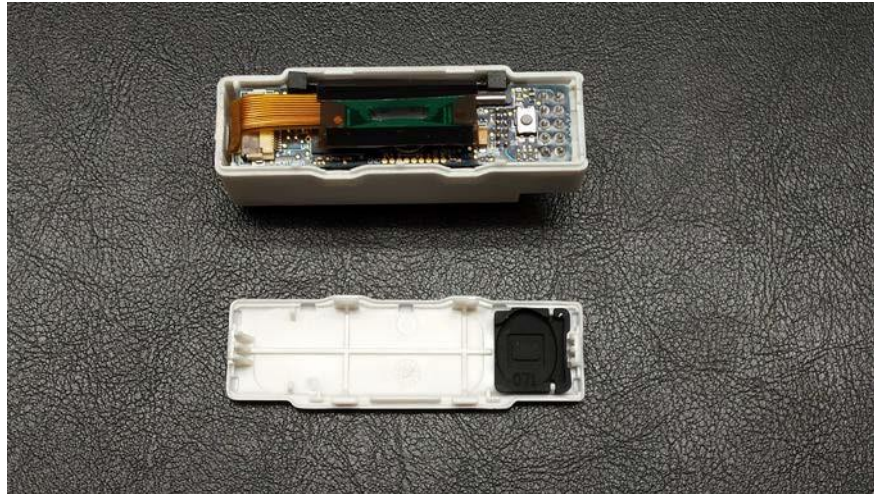

Reassemble in reverse.

Keypad Removal & Back Label

With the Lower housing, item 6, removed press on the keypad, item 3, to release it from the cover.



Reassemble in reverse order.

Back Labels – Legal Entity Change (Item 9) – Like for like replacement label should be used until stock is exhausted, newer Welch Allyn legal entity labels may be used once older labels are no longer available (example of legal entity label change shown below).

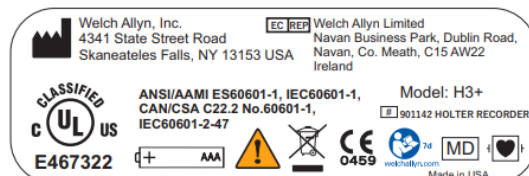
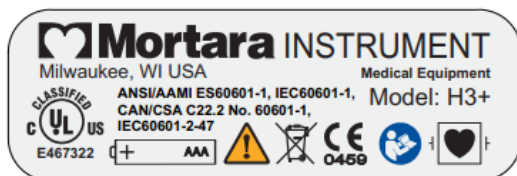

Board Removal

To remove the board and LCD assemblies from the unit first open the unit as described in the Cover Removal section.

Locate the battery spring of the unit and compress this spring and push the board and LCD assemblies through the opening of the Upper Housing, item 5.

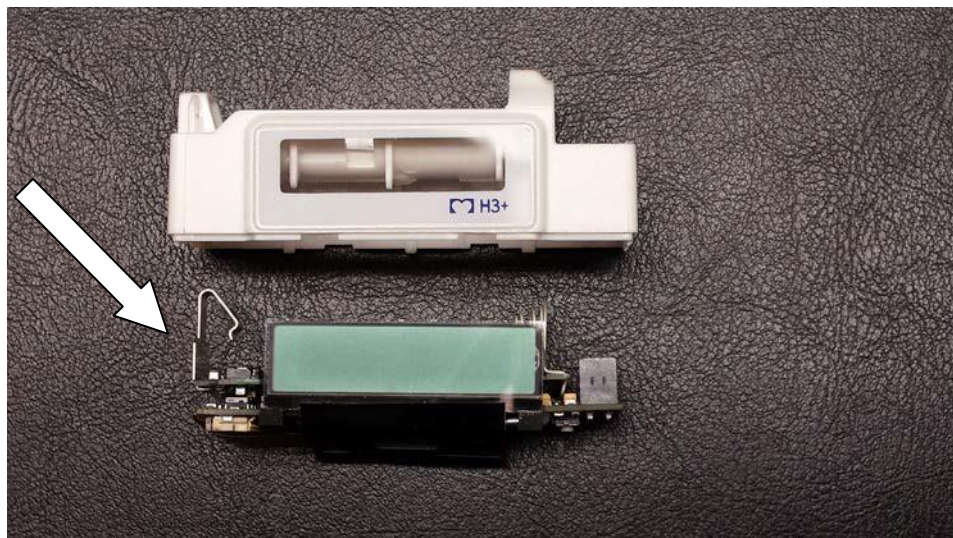

Reassemble unit in reverse order.

NOTE: The battery spring will need to be compressed slightly for the boards and LCD to seat properly into the case.

LCD Removal

With the LCD and Board assemblies removed from the unit the LCD (item 4) can be replaced by locating the cable connector, lifting up on the retaining latch and sliding the LCD cable out of its connector.

IMPORTANT: A new LCD (part # 774398) was introduced in June of 2022. Units manufactured with the new LCD can be repaired by simply replacing this part; if however the unit has an older LCD (part # 5400-015), identified by the comparison pictures below, additional parts will need to be replaced along with the addition of the newer LCD to ensure a proper fit.

The following parts should be replaced when installing a newer LCD (part # 774398) into a unit that has an existing older LCD (part # 5400-015).

- 774398 LCD MODULE CHIP ON GLASS 128x32
- 774585 KEYPAD ASSEMBLY H3+ V2
- 774586 H3+ LOWER HOUSING RECESSED



Caution: The LCD connector on the board is a fragile connector. Care must be taken when removing and installing the LCD cable into this connector.

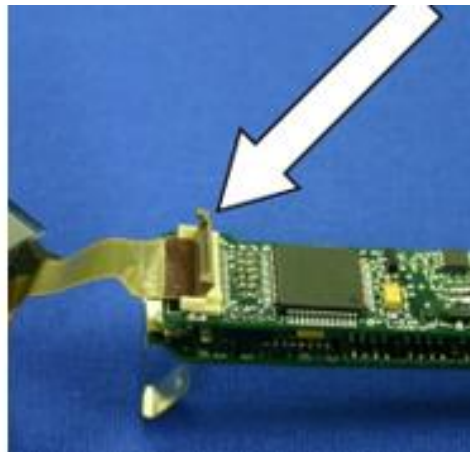

Install replacement LCD in reverse order (old and newer LCD shown below):

Old LCD (part # 5400-015)

New LCD (part # 774398)

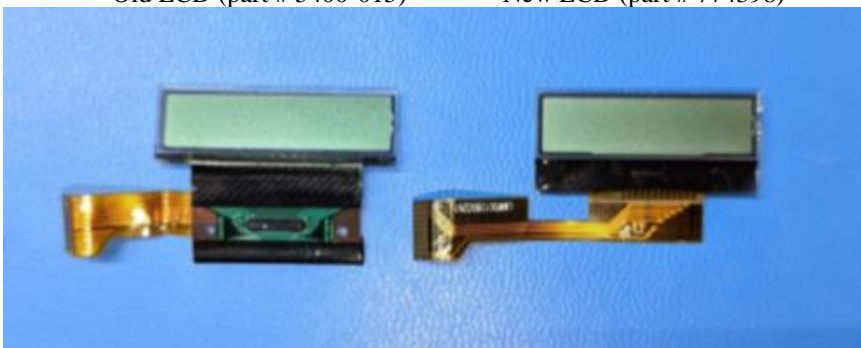

Board Separation

With the LCD, item 4, removed from the board assembly, locate the connectors holding the Front End board (item 2) and Digital Board (Item 1) together.

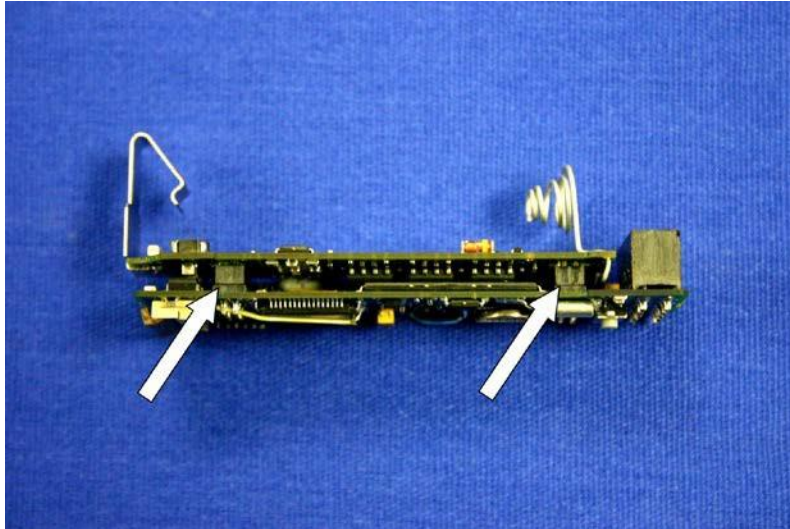

Gently separate the two boards.

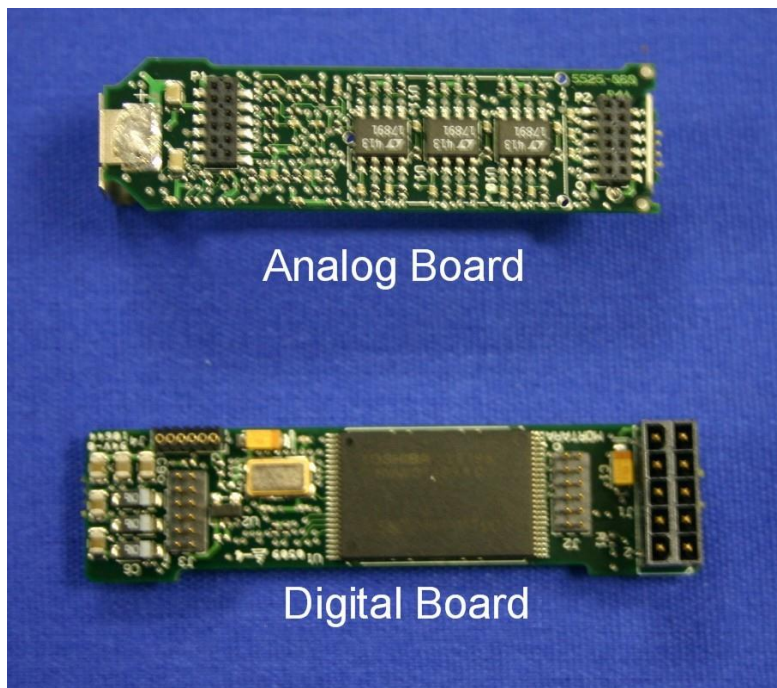

Reassemble unit in reverse order.

PRINTED CIRCUIT BOARDS

Introduction

This section provides block diagram illustrations of the H3+ Holter Recorder Printed Circuit boards. Due to the proprietary nature of this product schematics of the boards are not provided.

There is no user serviceable parts for the H3+, replacement units are available. Please contact Welch Allyn Technical Support via phone at 1-888-667-8272 or via email at mor_tech.support@hillrom.com for details regarding unit replacement.



Anti-Static equipment should always be worn when working with static sensitive devices and in a static sensitive area.

Block Diagram

The following diagram shows how the data is received and stored into the H3+

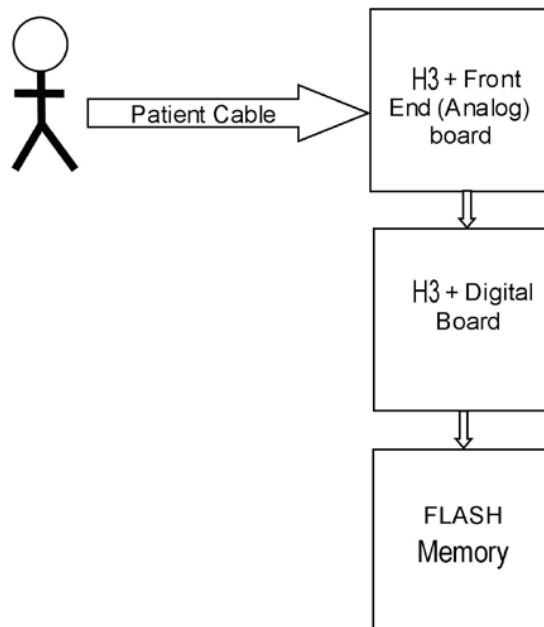

H3+ Front End PC Board

Block Diagram of H3+ Front End Board

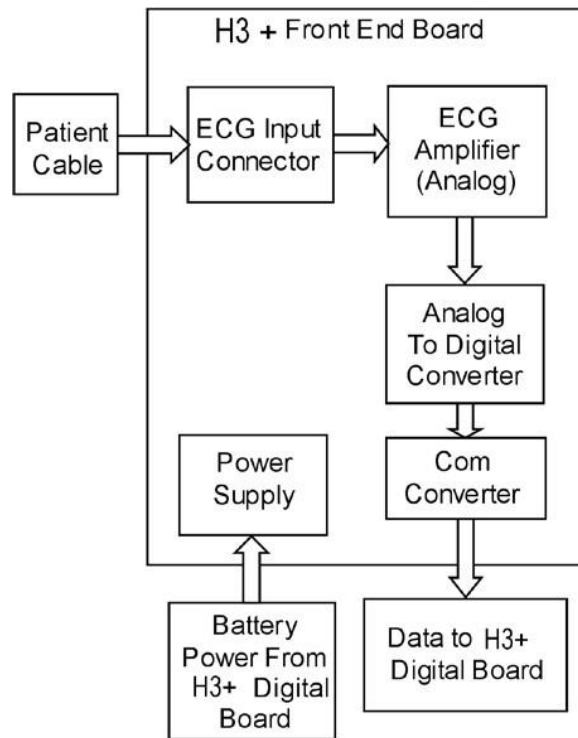

H3+ Digital PC Board

Block Diagram of H3+ Digital Board

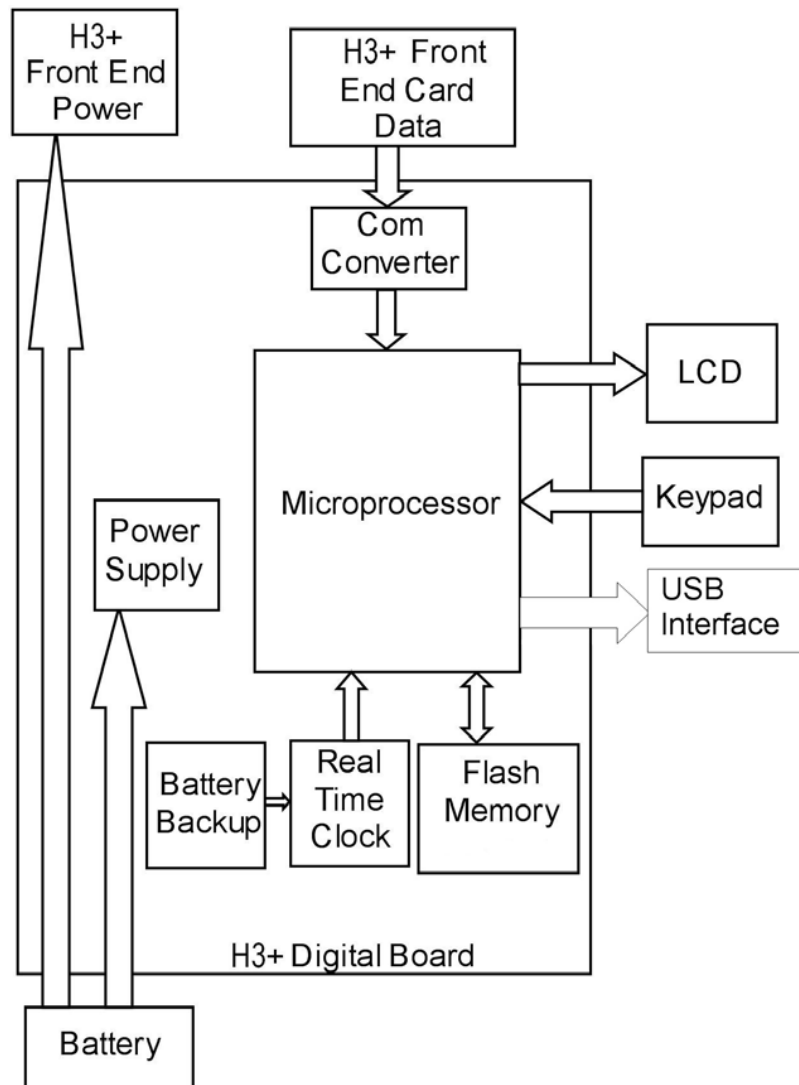

TROUBLESHOOTING

Introduction

This section contains testing and troubleshooting information and procedures. Repair of the H3+ is limited.



WARNING: *No user serviceable parts are inside. Any modification of this device will void any and all Manufacturer's Warranties and/or responsibilities. If you are not able to correct the H12+ Digital Recorder questionable operating state using the Troubleshooting guide in this manual, do not attempt to service the unit, contact Welch Allyn Service at 1-888- 667-8272 or via email at mor_tech.support@hillrom.com.*

The following system information log is provided for your convenience. You will need this information if the H3+ requires servicing. Be sure to update the information log when your device has been serviced.

Manufacturer:

**Welch Allyn, Inc. 4341 State
Street Road
Skaneateles Falls, NY 13153**

Telephone Numbers:

North America: 800-231-7437
European: +39.051.298.7811

Sales Department: 800-231-7437

Service Department: 888-667-8272

Product Information:

Name of Unit/Product:

Date of Purchase: ___ / ___ / ___

Purchased Unit From:

Serial Number: _____



Software Version: _____

For questions and service information, when calling have the serial number and part number available.

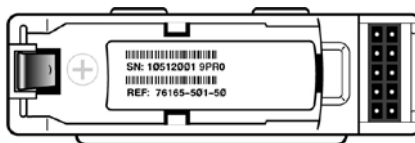
The Serial Number and Part Number (REF) are found under the battery, in the battery compartment of the unit similar to the one pictured below.

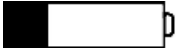

Serial Number (SN) and Part Number (REF) Location

Message	Description/Solution
	Replace existing battery with a fully charged battery.
ID:XXXXXXXXXX XXXXXXXXXXXXXX	Displayed prior to start of recording to confirm the ID has been entered. If the field after the ID: is blank, no ID has been loaded to the H3+. Reverse color (white on dark background) indicates that the recording period is complete and recording has stopped. A new recording cannot begin until the memory is erased.
	Wrong 2-channel patient cable connection. Recording cannot proceed until the proper 3-channel cable is connected.
	Lead fail indication during recording. Check that all lead wires and electrodes are connected. Check that the patient cable is connected to the recorder.
R	Recording indication.
↓	Event marker indication.
USB	Indicates that the H3+ USB download cable is connected to the H3+.
'RA'	RA in fail during hookup. Check if the lead wire is off or the electrode needs to be replaced.
'LA'	LA in fail during hookup. Check if the lead wire is off or the electrode needs to be replaced.
'LL'	LL in fail during hookup. Check if the lead wire is off or the electrode needs to be replaced.
'V'	V in fail during hookup. Check if the lead wire is off or the electrode needs to be replaced.
A combination of 'RA...V'	More than one lead in fail or all leads in fail during hookup. Check the lead wires and electrodes.

Device Log Files

Device log and record logs have been introduced with V3.0.0 software and will not be available on previous models. Service log files containing information for Welch Allyn technical support personnel are written to the recorder and available by viewing the H3+ recorder using Windows Explorer. The files, DEVICE.LOG and RECORD.LOG can be copied and e-mailed to Welch Allyn for troubleshooting purposes. These files are erased when the recorded ECG data is erased in preparation for the next recording.

DEVICE.LOG

```
Serial Number: ENG4
Firmware Version: 3.0.0.21
Hardware Version: 2.0
Config Version: 3.0.0.7
Number of recordings: 2
Recording present: YES
Recording acquired: YES
```

Recorder information to assist Mortara Technical Support during complaint investigations.

```
Encoding algorithm: 0
NAND Chip ID: 0x3600382c
NAND Geometry:
  Page size (bytes): 4096
  Pages per block: 128
  Physical blocks: 2048
  Logical blocks (2-pages each): 896
  Spare logical blocks (2-pages each): 128 (even), 128 (odd)
  Spare area size (bytes): 128
NAND write errors = 0
NAND erase errors = 0
NAND read errors (correctable) = 27
NAND read errors (not correctable) = 0
NAND config block marker = 1
NAND 512-byte sector count = 1835008
NAND bad block count = 0
NAND bad block list:
```

Used for Welch Allyn Engineering level investigations.

```
NAND logical block list (even, odd):
( 0, 1)
( 2, 3)
( 4, 5)
( 6, 7)
( 8, 9)
```

NAND logical block data may continue for many pages. Data can be used to confirm when a NAND block has been skipped and assigned to a spare block.

RECORD.LOG

```

Patient ID: NORBERT04
Programmed record duration: 48 hours
Actual record duration: 16 hours, 46 minutes, 28 seconds
12/20/2014 10:34:17 Power on (record mode)
12/20/2014 10:34:19 3-Channel Cable Detected
12/20/2014 10:34:43 Recording started
Prep button press count = 7
Diary event, ADC saturation, and lead-fail state changes:
Date      Time      ADC1 ADC2 ADC3 RA  LA  LL  V  DE
12/20/2014 10:34:43 Battery: 1.593V, Pace Count: 0
12/20/2014 10:34:43                                     X
12/20/2014 10:34:44
12/20/2014 11:34:43 Battery: 1.581V,
12/20/2014 12:34:43 Battery: 1.563V,
12/20/2014 13:34:43 Battery: 1.556V,
12/20/2014 14:34:43 Battery: 1.551V,
12/20/2014 15:34:43 Battery: 1.532V,
12/20/2014 16:34:43 Battery: 1.543V,
12/20/2014 17:34:43 Battery: 1.539V, Pace Count: 7
12/20/2014 18:22:02                                     X
12/20/2014 18:22:03
12/20/2014 18:34:43 Battery: 1.529V, Pace Count: 3
12/20/2014 19:34:43 Battery: 1.520V, Pace Count: 0
12/20/2014 20:34:43 Battery: 1.525V, Pace Count: 0
12/20/2014 21:34:43 Battery: 1.520V, Pace Count: 1
12/20/2014 22:34:43 Battery: 1.517V, Pace Count: 4
12/20/2014 23:34:43 Battery: 1.509V, Pace Count: 5
12/21/2014 00:34:43 Battery: 1.508V, Pace Count: 1
12/21/2014 01:34:43 Battery: 1.504V, Pace Count: 0
12/21/2014 02:34:43 Battery: 1.501V, Pace Count: 0
12/21/2014 03:34:43 Battery: 1.494V, Pace Count: 0
12/21/2014 04:34:43 Battery: 1.493V, Pace Count: 0
12/21/2014 05:34:43 Battery: 1.495V, Pace Count: 0
12/21/2014 06:34:43 Battery: 1.491V, Pace Count: 3
12/21/2014 07:21:45                                     X
12/21/2014 07:21:46
12/21/2014 07:34:43 Battery: 1.490V, Pace Count: 0
12/21/2014 08:34:43 Battery: 1.486V, Pace Count: 5
12/21/2014 09:34:43 Battery: 1.480V, Pace Count: 4
12/21/2014 10:34:43 Battery: 1.479V, Pace Count: 2
12/21/2014 11:34:43 Battery: 1.472V, Pace Count: 1
12/21/2014 12:11:03      X   X   X
12/21/2014 12:11:04      X   X   X
12/21/2014 12:11:05      X   X   X
12/21/2014 12:34:43 Battery: 1.472V, Pace Count: 2

```

Recorder setup and recording start details.

Data point at each hour interval will be logged to show the date, time and corresponding battery voltage.

Indicates a lead failure during the Holter recording. The corresponding date and time will be logged for each occurrence.

CONFORMANCE TESTING

Introduction

This section contains the conformance test process and the test data record for the H3+recorder.



WARNING: No user serviceable parts are inside. Any modification of this device will void any and all Manufacturer's Warranties and/or responsibilities. If you are not able to correct the H12+ Digital Recorder questionable operating state using the Troubleshooting guide in this manual, do not attempt to service the unit, contact Welch Allyn Service at 1-888- 667-8272 or via email at mor_tech.support@hillrom.com.

1. Definition of Terms

DUT	Device Under Test
DMM	Digital Multi-Meter
USB	Universal Serial Bus
LCD	Liquid Crystal Display

2. Required Equipment

Qty	Tooling ID	Description / Requirements
1	Host PC	PC with Windows XP operating system or newer. Monitor Resolution: 1024x768x16bits or higher
1	11010-015-01	H3+ USB Configuration Utility Application Software used to set/retrieve Date & Time; Patient ID; Serial Number; Erase H3+ Data Memory; and Download ECG data to the PC
1	11010-015-02	H3+ Reviewer Application Software used to review ECG data.
1	TF-0423	H3+ Signal Attenuation Fixture.
1	Agilent 33220A	Arbitrary Waveform Generator (or equivalent) set up to recall states as defined in Appendix A.3
1	9293-036-50/-51	3 Lead H3+ patient Cable
1	25019-006-50	H3+ USB cable
1		Digital Multi-Meter
1		5 Volt DC Power Supply
1		50 ohm Coax Cable with BNC connectors approximately 2'
1	EL422	DC High Voltage Power supply or DC HIPOT Test Equipment
1	TF-0424	H3+ HI-POT Strength Test Fixture
1	20026145	H3+ HIPOT Strength Test Fixture (new back housing)

3. Initial Setup

- 3.1 Set up the test configuration per the instructions in Appendix A.1 Test Configuration Set Up. This includes the Attenuation Box (TF-0423) switch settings.
- 3.2 Ensure the Signal Generator contains the programmed waveforms (or can be configured for appropriate output) as defined in Appendix A.2 Test Signal Waveforms.

4. Initial Power Up, Self-Test

- 4.1 Power on the device using an external power supply set at 1.5VDC \pm 0.1VDC with an ammeter in series to measure the current.
- 4.2 Remove and reapply power to the DUT.
 - Verify the DUT powers on as indicated by the firmware version number being displayed on the LCD.
 - Verify the current is <20mA when the firmware version is being displayed.

5. Patient Cable & Lead-Fail Check

- 5.1 Connect a 3-Lead patient cable from a shorting bar to the DUT.
 - Verify the DUT display indicates 3-CH
- 5.2 Press the EVENT button several times to get to the V-Lead display.
 - Verify the signal is flat-lined.
- 5.3 Remove and reconnect each lead (e.g., LL, LA, RA, V) independently from the shorting bar. RL does not apply.
 - Verify the DUT displays a square wave and the corresponding lead label indicating a lead-off detection.

6. DUT Configuration

- 6.1 Remove the power source/battery from the DUT. Ensure the Host PC is powered on. Connect the DUT to the Host PC via the H3+ USB cable. Ensure an ammeter is connected to the test fixture.
 - Verify the DUT display indicates USB
 - Verify the current is <100mA
- 6.2 Open the USB Configuration Utility by clicking on the applicable DESKTOP ICON. Select the Get Status button.

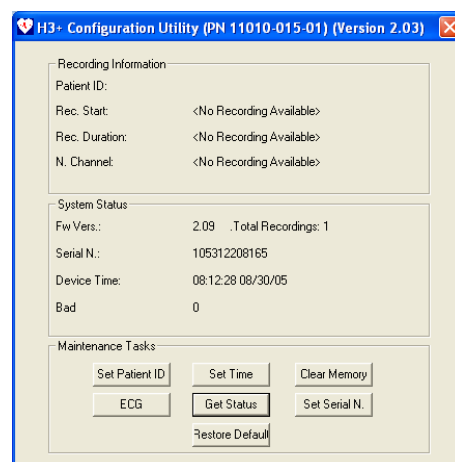

Verify the following items:

- There is “No Recording Available”. If there is, select the Clear Memory button to erase the recording.
- System Status: “FwVers”- Applicable released firmware version.
- System Status: “Bad” is typically 0 or 1 bad blocks. Limit <80

Note: “Total Recordings” is a running count of all recordings. Total recordings and serial number may be cleared/reset by selecting the Restore Default button.

6.3 Set the DUT Date/Time by selecting the Set Time button.

Note: The Date and Time will be populated with the Host PC data.

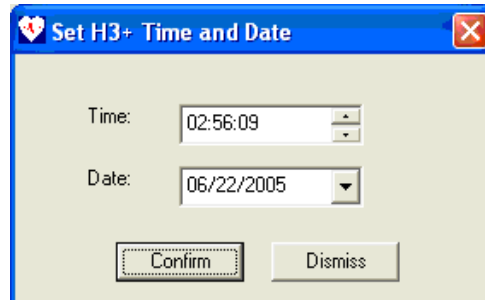

Ensure the date/time are correct, then select Confirm. Select OK
Remove the H3+ USB cable.

7. Record Mode

7.1 Insert a AAA battery into the DUT and close the battery cover.

- Verify the DUT powers ON and the firmware version is displayed on the LCD.

7.2 Connect the 3-Lead Patient Cable to the DUT.

- Verify “3-CH” is displayed on the DUT LCD indicating the cable is detected.

7.3 Press the DUT Event Button to advance to the TIME display.

7.4 Press the DUT Event Button to advance to the ID: display.

7.5 Press the DUT Event button a few times to advance through the “Display Loop” (Lead I, Lead II, V-Lead, Time).

- Verify the signal is a square wave in each channel.

7.6 Set the DUT in record mode.

- Press the Event Button as needed to get to the time display. At the time display, press and hold the Event button (approximately 10 seconds) until the “Time” is prefixed with an “R” indicating the DUT is recording.

Note: Once in the “Display Loop” (i.e., Lead I, Lead II, V, Time) the DUT will automatically go into the record mode after 10 minutes.

7.7 Press the Event button

- Verify a “down arrow” is displayed associated with the press.

8. Test Data Acquisition

- 8.1 Induce each of the test waveform signals (e.g., Flat line, 0.5Hz Sine Wave, 20Hz Sine Wave, Pace Pulses, DC Offset). This is approximately 2 minutes of test data.
- 8.2 Connect the signal generator to the Attenuation box (TF-0423) as described in appendices A.1 and A.2. Connect the 3-CH patient cable from TF-0423 to the DUT. Turn the signal generator ON.
 - Flat Line
 - Signal Generator: Output OFF
 - Allow DUT to acquire about 10 seconds of Flat line data.
 - Low-Frequency Gain Signal
 - Refer to Appendix A.2
 - Acquisition Duration: Approximately 10 seconds
 - High-Frequency Gain Signal
 - Refer to Appendix A.2
 - Acquisition Duration: Approximately 10 seconds
 - Pace Pulse Detection
 - Refer to Appendix A.2
 - Acquisition Duration: Approximately 10 seconds
 - DC Recovery
 - Refer to Appendix A.2
 - Acquisition Duration: Approximately 30-40 seconds
 - Stop Recording
 - Turn the Signal Generator output OFF.
 - Remove the battery from the DUT to stop the recording.
 - Remove the 3-Lead Patient Cable from the DUT.

9. Performance Verification

- 9.1 Connect the DUT to the Host PC via the H3+ USB cable. The Host PC should provide an audio signal indicating the DUT was connected or disconnected.
- 9.2 Open the USB Configuration Utility application by clicking on the applicable DESKTOP ICON.
- 9.3 Select the Get Status button.
 - Verify the Software Version, Date & Time and serial number are correct.
 - Verify the Rec. Duration: Indicates the correct amount of time for the recorded data.
- 9.4 Acquire the ECG by selecting the ACQUIRE ECG button.

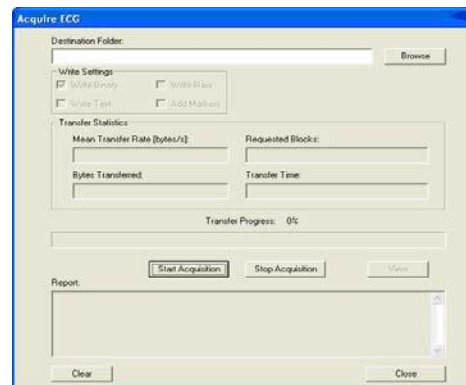

Select the Browse button and highlight the desired folder.

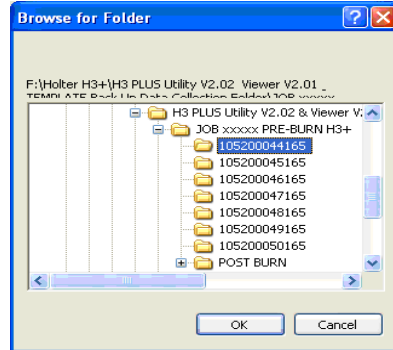

Select OK

9.5 Select Start Acquisition to get the data from the DUT.

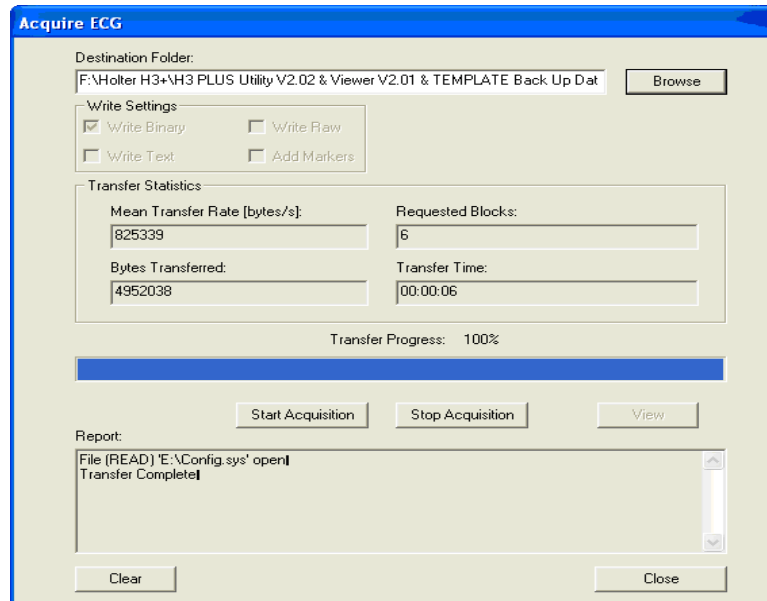

The "Report" field should indicate "Transfer Complete" when done.

Select Close.

- 9.6** Open the ECG Viewer by clicking on the applicable DESKTOP ICON.
 Select File; Open.
 Leave the P.M. File Name, File Format, Sample Format and Rec. Mode settings at the default values.

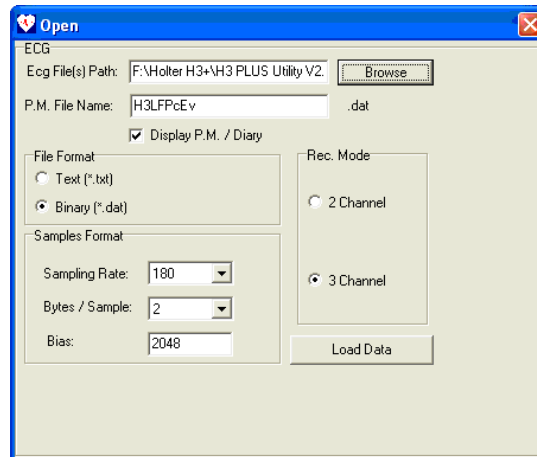

- 9.7** Get the Data for review.
 Select the Browse button.

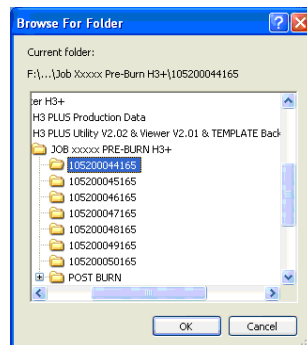

Highlight the desired date folder and Select OK. Then select the Load Data button to read the files. The viewer displays 3 channels of data with the folder name at the top.

- 9.8** Using the navigation buttons at the lower left tool bar of the ECG Viewer application, go to the end of the data. Review the data by scrolling backwards in time. It is suggested to use a 5 second time increment.

Note: The test signals will be reviewed in the reverse order of how they were acquired.

9.9 DC Recovery Verification

Scroll to the 0.05 DC Recovery Data

Settings- Samples/Pxl: 1; Gain (mm/mV): 10; Scroll by: 5 Seconds

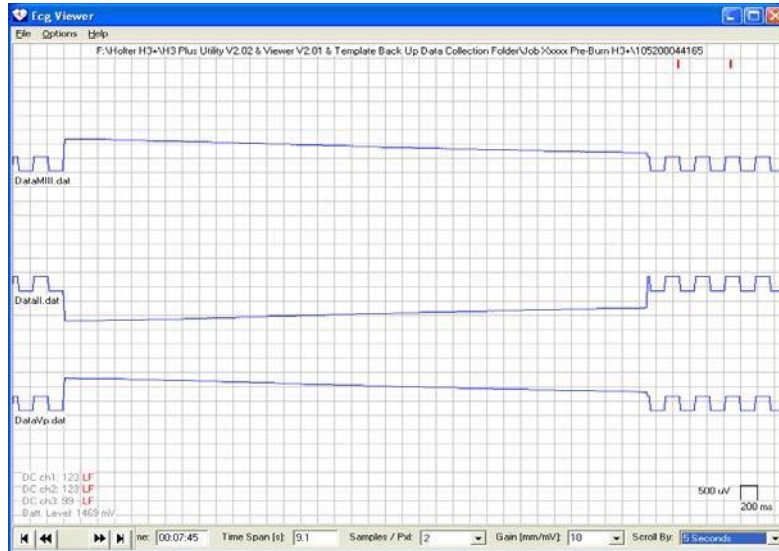

- Verify each channel: The signal does not exceed ± 4 division from the center of the square wave.
- Verify each channel: The signal recovers towards the baseline.

9.10 Pace Pulse Detect Verification

Scroll to the PACE data

Settings- Samples/Pxl: 1; Gain (mm/mV): 10; Scroll by: 5 Seconds

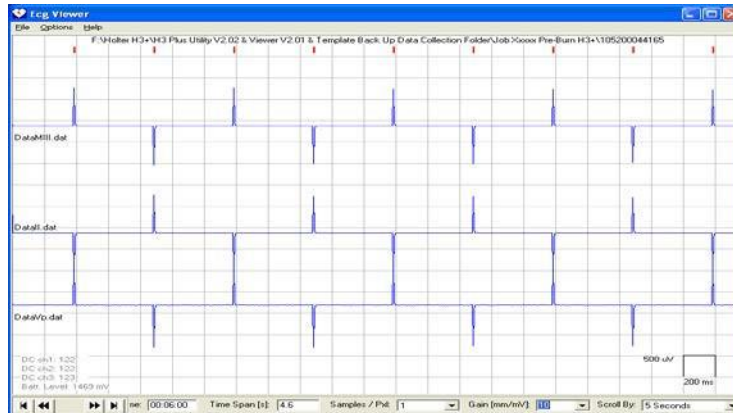

- Verify each channel: Contains pace spikes every 0.25 seconds alternating positive and negative.
- Verify PACE detected as indicated by the RED MARK above each pulse at the top of the display.

9.11 High-Frequency Gain Verification
 Scroll to the 20.0 Hz data.

Settings- Samples/Pxl: 1; Gain (mm/mV): 10; Scroll by: 5 Seconds

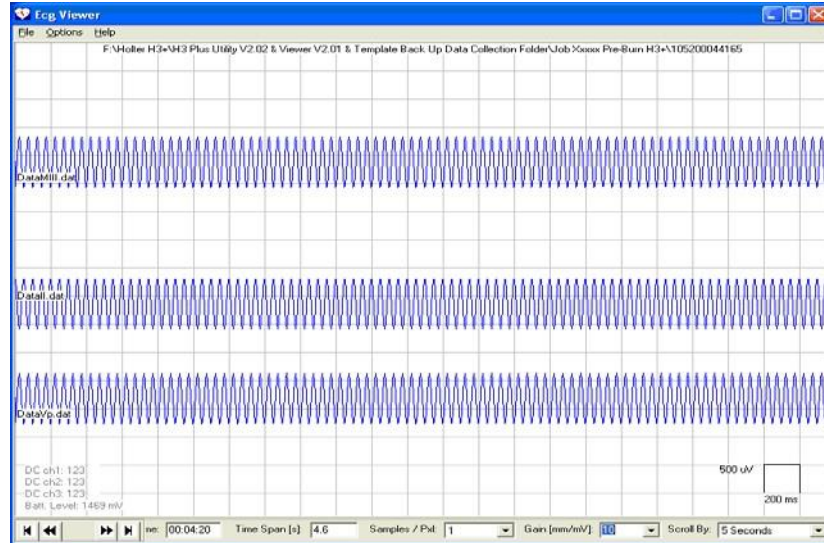

- Verify each channel: 20Hz Sine Wave, 1mV (within 1.5-2.5 divisions).

9.12 Low-Frequency Gain Verification

Scroll to the 0.5 Hz data.

Settings- Samples/Pxl: 1; Gain (mm/mV): 10; Scroll by: 5 Seconds

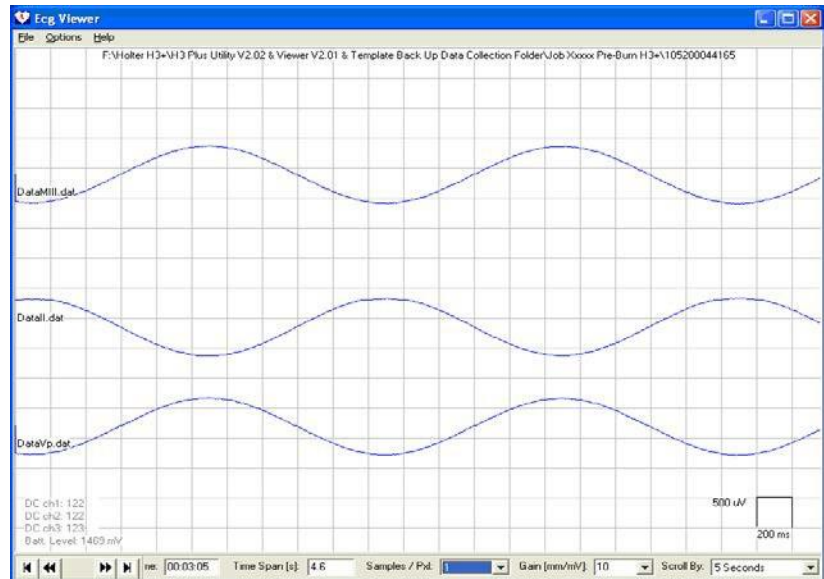

- Verify each channel: 0.5 Hz Sine Wave, 1mV (2 divisions +/- 1/2 division).

9.13 Signal Noise & Event button test

Settings- Samples/Pxl: 1; Gain (mm/mV): 160; Scroll by: 5 Seconds

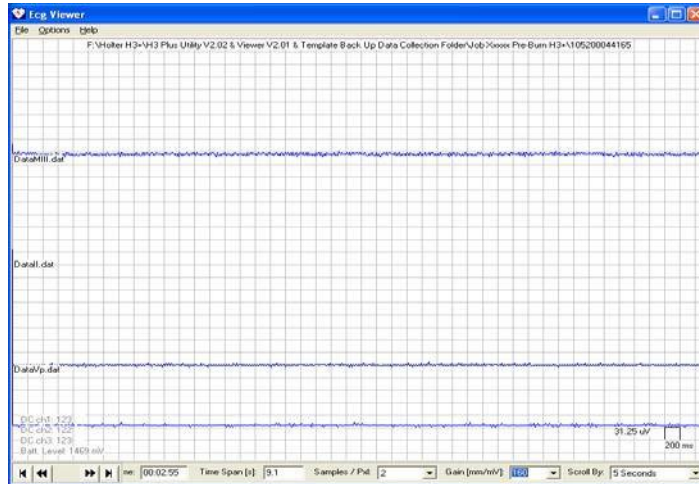

- Verify the noise in each channel is less than 30uV (within 1 division
- ie. 0uV +/- 15uV)
- Verify EVENT button detection as indicated by the GREEN MARK at the top display at the time the event button was pressed.

9.14 Close the ECGViewer Application.

10. Clear DUT Memory

- 10.1** From the USB Configuration Utility, erase the DUT memory by selecting the Clear Memory button and select OK.
Select Get Status

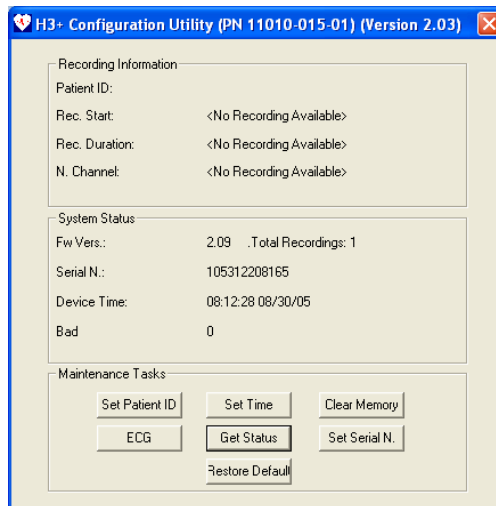

- Verify recording was erased <No Recording Available>.

11. Battery Current Check

- 11.1** Connect the DUT to an external power source (1.5 ± 0.1 VDC) with an Amp Meter in series with the positive output of the power source.

Turn the power source output ON.

- Verify the DUT powers ON to the Version screen and the current is <20 mA.

Safety Testing - Dielectric Strength (patient Input to enclosure)

Required Equipment

	Shorting Bar for ECG Patient Cable
	H3+ 3-Lead Patient Cable
	DC High Voltage Power supply or DC HIPOT Test Equipment
TF-0424	H3+ HI-POT Strength Test Fixture
20026145	H3+ HIPOT Strength Test Fixture (new back housing)

Test Criteria:

Item	Value	Unit of Measure	Boundary
Applied Potential	5K	Volts DC	Minimum
Frequency	DC	Hz	
Ramp Time	3.0	Seconds	Minimum
Dwell Time	1.0	Seconds	Minimum
Current High	0.20 (200 uA)	mA	Maximum
Current Low	0.0	mA	Minimum

IMPORTANT: A change to the H3+ LCD and lower housing made during 2022 required a new HI-POT tool to be used for these newer units to accommodate the minor change in physical size in the H3+ unit. Based on the size of the unit being tested, use the appropriate tool and procedure defined below.

Testing process (Units with 8348-002-x0 lower housing - use TF-0424):

- Connect ALL leads of the ECG cable to a shorting bar and insert the cable into the UUT.
- Connect (+ Red Lead) to the ECG shorting bar
- Connect (- Black Lead) to TF-0424.
- Initiate Dielectric Strength Test and record results on TDR.

Testing process (Units with 774586 lower housing - use TF-20026145):

- Connect the patient cable portion of tool 20026145 to the UUT and insert the UUT into the fixture.
- Connect (+ Red Lead) to the portion of the fixture that is designed to provide contact to the UUT housing.
- Connect (- Black Lead) to the patient cable portion of tool 20026145.
- Initiate Dielectric Strength Test and record results on TDR.

Disconnect process:

- Ensure the output of the HIPOT test equipment is disabled (OFF).
- Remove the HIPOT test leads from the UUT using only one hand, one lead at a time for safety purposes, then remove the ECG cable from the UUT.

H3+ Conformance Test Data Record

UNIT SERIAL # _____

Perform Visual Inspection of Unit Pass Fail

Initial Power Up, Self Test

4.2 Firmware Version _____

4.2 Operating Current (<20mA) _____ mA Pass Fail

Patient Cable & Lead-Fail Check

5.1 3-Lead Patient Cable Detected Pass Fail

5.2 Shorting Bar Flat Line Observed Pass Fail

5.3 Lead Fail Test (All Leads tested excluding RL) Pass Fail

DUT Configuration

6.1 USB Communication Pass Fail

6.1 USB Current Draw (<100mA) _____ mA Pass Fail

6.3 Date/Time Set Pass Fail

Performance Verification

9.9 Verify Waveforms

DC Recovery Pass Fail

Pace Pulse Detection Pass Fail

High-Frequency Gain Signal Pass Fail

Low-Frequency Gain Signal Pass Fail

Signal Noise & Event Button Pass Fail

10.1 Clear Memory Pass Fail

11.1 Operating Current (<20mA) _____ mA Pass Fail

Safety Test - Dielectric Strength (patient Input to enclosure) Pass Fail

Performed by: _____ Date: ____ / ____ / ____

A.0 Appendices

A.1 Test Configuration Set Up

A.1.1 Connect Signal Generator (Agilent 33220A (20MHz Function/Arbitrary Waveform Generator or equivalent) output to the Attenuation Box TF-0423 via a 50ohm Coax Cable. A scope may be connected in-line using a T-splitter.

Note: The Attenuation box (TF-0423) must be at the end of the connection as it contains a 50ohm matching impedance to properly load the Signal Generator output. If this is not done the amplitude of the output signals will be double the desired values.

Connect H3+ 3-lead Patient Cable to the applicable banana jack/snap outputs of TF-0423.

Attenuation Box (TF-0423) Switch Settings

- Attenuation 10:1
- V1-V6 & LL= Signal
- RL; RA; LA= Ground

A.2 Test Signal Waveforms

A.2.1 Test Waveforms should be programmed into the Agilent 33220 Signal Generator or equivalent prior to performing the conformance testing.

Signal	Description	Attenuation	Effective Amplitude	Signal Generator	Application Time
1 Noise	Form: Flatline	10:1	0mV pp	Output OFF	10 seconds
2 Low-Freq Gain	Form: Sine-Wave Freq: 0.5 Hz Amplitude: 10mVpp DC offset 0	10:1	1mV pp	RecallState 1	10 seconds
3 High Freq Gain	Form: Sine Wave Freq: 20Hz Amplitude: 10mVpp DC offset: 0	10:1	1mV pp	RecallState 2	10 Seconds
4 Pace Pulse	Form: 2ms pulses alternating POS/ NEG every 0.5 seconds. Freq: 1 Hz Amplitude: 60mVpp DC Offset: 0	10:1	2mVp Pos. 2mVp Neg.	RecallState 3	10 Seconds
5 DC Recovery	0.05Hz Square Wave 50% Duty Cycle Amplitude: 2Vpp DC Offset: 0	10:1	100mVp Pos. 100mVp Neg.	RecallState 4	30-40 Seconds