

# Vital Signs Monitor 300 Series

---



---

## Directions for use

Software version 1.2X

**WelchAllyn**<sup>®</sup>

Advancing Frontline Care<sup>™</sup>

© 2014 Welch Allyn. All rights are reserved. To support the intended use of the product described in this publication, the purchaser of the product is permitted to copy this publication, for internal distribution only, from the media provided by Welch Allyn.

Welch Allyn assumes no responsibility for any injury to anyone, or for any illegal or improper use of the product, that may result from failure to use this product in accordance with the instructions, cautions, warnings, or statement of intended use published in this manual.

Welch Allyn is a registered trademark of Welch Allyn.

Nellcor is a registered trademark of Nellcor Puritan Bennett Inc.

Software in this product is copyright Welch Allyn or its vendors. All rights are reserved. The software is protected by United States of America copyright laws and international treaty provisions applicable worldwide. Under such laws, the licensee is entitled to use the copy of the software incorporated with this instrument as intended in the operation of the product in which it is embedded. The software may not be copied, decompiled, reverse-engineered, disassembled or otherwise reduced to human-perceivable form. This is not a sale of the software or any copy of the software; all right, title and ownership of the software remains with Welch Allyn or its vendors.

For information about any Welch Allyn product, visit [www.welchallyn.com/en/about-us/locations.html](http://www.welchallyn.com/en/about-us/locations.html).

DIR 80019418 Ver A



Welch Allyn Protocol Inc.  
8500 SW Creekside Place  
Beaverton, OR 97008  
USA

EC REP

Regulatory Affairs Representative  
Welch Allyn Limited  
Navan Business Park  
Dublin Road, Navan  
County Meath, Republic of Ireland

[www.welchallyn.com](http://www.welchallyn.com)



**WelchAllyn**<sup>®</sup>

# Contents

---

<b>1 - General Information</b> .....	<b>1</b>
About This Manual .....	1
Intended Use .....	1
Symbols .....	2
Product Overview .....	3
Warnings and Cautions .....	4
Displays, Indicators, Controls, and Connections .....	6
<b>2 - Setup</b> .....	<b>9</b>
Connections .....	9
Power On, Power-on Self-Test, and Power Off .....	15
Configuring Operating Parameters .....	16
<b>3 - Patient Monitoring</b> .....	<b>29</b>
Monitoring Blood Pressure .....	29
Monitoring Pulse Rate .....	36
Monitoring SpO <sub>2</sub> .....	37
Monitoring Temperature .....	40
<b>4 - Alarms and Alerts</b> .....	<b>51</b>
Responding to a Patient Alarm .....	51
Responding to an Equipment Alert .....	52
Alarm Indicators .....	54
Setting Alarms .....	54
Nurse Call .....	57
Error Codes .....	58
<b>5 - Reviewing Patient Data</b> .....	<b>59</b>
Displaying Stored Patient Data .....	59
Printing Patient Data .....	59
Erasing Patient Data .....	65
Replacing the Printer Paper Supply .....	66
<b>6 - Operator Maintenance</b> .....	<b>67</b>
Cleaning .....	67
Storage .....	67
Recycling Monitor Components .....	68

**7 - Reference . . . . . 69**  
    Battery Operation . . . . . 69  
    Monitor Specifications . . . . . 71  
    Factory Default Settings . . . . . 80

**Limited Warranty . . . . . 81**

**Index . . . . . 83**

## 1

# General Information

---

## About This Manual

This manual contains information about the Welch Allyn® Vital Signs Monitor 300 Series monitor. The series includes the following models:

<b>Model</b>	<b>Features</b>	<b>Model</b>	<b>Features</b>
<b>53000</b>	Standard (NIBP, Pulse Rate, and MAP)	<b>53N00</b>	Standard + Nellcor® SpO <sub>2</sub>
<b>5300P</b>	Standard + Printer	<b>53NT0</b>	Standard + Nellcor SpO <sub>2</sub> + Temperature
<b>530T0</b>	Standard + Temperature	<b>53N0P</b>	Standard + Nellcor SpO <sub>2</sub> + Printer
<b>530TP</b>	Standard + Temperature + Printer	<b>53NTP</b>	Standard + Nellcor SpO <sub>2</sub> + Temperature + Printer

All operators must read and understand this manual before using the monitor.

All technicians and other service personnel must read and understand this manual before attempting to set up, configure, troubleshoot, or service the monitor.

All information in this manual, including the illustrations, is based on a monitor configured with the Temperature, SpO<sub>2</sub>, and Printer options. If your monitor configuration lacks any of these options, then some information in this manual does not apply.

## Intended Use











The VSM series of monitors are intended to be used by clinicians and medically qualified personnel for monitoring of noninvasive blood pressure, pulse rate, body temperature, noninvasive functional oxygen saturation of arteriolar hemoglobin (SpO<sub>2</sub>), and body temperature in normal and axillary modes of neonatal, pediatric and adult patients.

The most likely locations for patients to be monitored are general med/surg. floors, general hospital and alternate care environments. This device is available for sale only upon the order of a physician or licensed health care professional.







# Symbols

The symbols illustrated on the following pages appear on the monitor or in this document.







**Table 1. Symbols: Certification and Operation**

	This device has been tested and certified by the Canadian Standards Association International to comply with applicable U.S. and Canadian medical safety standards.		Urgent alarm notification (output to Nurse Call system)
	The CE Mark and Notified Body Registration Number signify that the device meets all essential requirements of the European Medical Device Directive 93/42/EEC.		Recycle used batteries properly and in accordance with local regulations. Do not dispose of batteries in refuse containers.
	WELCH ALLYN PTY LTD 508-46 SOUTH STREET PYRALMERE, NSW 2116 AUSTRALIA		Sealed lead-acid battery, 6V 4 Ah
	Recycle the monitor and battery separately from other disposables. (See “Recycling Monitor Components” on page 68.)		
	Patient connections are Type BF, and protected against defibrillation.		
	<b>WARNING</b> Indicates conditions that could lead to illness, injury, or death.		
	<b>Caution</b> In this manual, indicates conditions that could damage equipment or other property.		
	<b>Caution</b> On the product, means “Consult accompanying documentation.”		

**Table 2. Symbols: Shipping, Storing, and Environment**

	Keep this end of the package or shipping crate up.		Protect the monitor from exposure to rain.
	Fragile contents—handle with care.		Do not subject the monitor to altitudes outside these limits.
	Do not expose the monitor to relative humidity above this limit.		Limit stacking to this number of units.
	Do not expose the monitor to temperatures outside these limits.		

**Table 3. Symbols: Connectors**











	Temperature Probe Cable Connector		SpO <sub>2</sub> Sensor Cable Connector
	RS232 Cable Connector		AC Power Adapter Cable Connector 8V 740mA
	Nurse Call Cable Connector		NIBP Hose Connector

**Table 4. Symbols: Printer Door**











	Press to open the printer door		Load paper this direction
---	--------------------------------	---	---------------------------

The functions of the monitor front panel controls illustrated here are described in detail elsewhere in this document.

**Table 5. Front Panel Controls**

 Set alarm limits	 Power on/off
 Silence alarms	 Print patient data
 Scroll up/down Scroll forward/back Increase/decrease value	 Review patient data
 (The scroll icon appears as these two arrows in the documentation.)	
 Set an NIBP automatic measurement interval	 Start/stop an NIBP cycle (AUTO button)
 Cycle to the next menu selections	

**Table 6. Front Panel Displays and Indicators**

<b>SYS</b> Systolic pressure	 Temperature
<b>DIA</b> Diastolic pressure	
<b>SpO2</b> Arterial hemoglobin oxygen saturation	
 /min Pulse rate	 Pulse strength
message window MAP (mean arterial pressure)	 Neonatal
 Degrees Celsius	 Pediatric
 Degrees Fahrenheit	 Adult
 Monitored temperature	 AC power
 Battery discharged	Battery charging (flashing) Battery charged (steady)

## Product Overview

The monitor can monitor systolic and diastolic noninvasive blood pressure (NIBP), pulse rate, and MAP (mean arterial pressure). Units configured with the appropriate options can also simultaneously monitor temperature and SpO<sub>2</sub>, and can continuously monitor pulse rate.

All vital-sign measurements are displayed on the front panel of the monitor. These measurements can also be printed, using the optional integrated thermal printer.

The monitor provides programmable audible and visual alarms and automatic NIBP measurements at selectable intervals. It can also be configured to provide an alarm-activated Nurse Call function.

Accessory equipment connected to the analog and digital interfaces must be certified to the respective IEC standards (IEC 60950 for data-processing equipment, IEC 60601-1 for

medical equipment). All such configurations must comply with system standard IEC 60601-1-1.



**Caution** Anyone connecting additional equipment to the signal input part or signal output part of this monitor **configures a medical system** and is responsible for verifying that the system complies with the requirements of the system standard IEC 60601-1-1. Changes or modifications not expressly approved by Welch Allyn could void the purchaser's authority to operate the equipment.

## Warnings and Cautions

All operating and service personnel must be familiar with the information presented here, and with other warnings and cautions which appear throughout this document.

Warning and caution labels can appear on the monitor, the packaging, the shipping container, or in this document.

## General Warnings



**WARNING** Many environmental variables, including patient physiology and clinical application, can affect the accuracy and performance of the device. The clinician must verify all vital signs information prior to patient intervention.

**WARNING** The monitor is for use only by medical clinicians. Although this document might illustrate medical monitoring techniques, the monitor must be used only by trained clinicians who know how to take and interpret a patient's vital signs.

**WARNING** During defibrillation, keep the defibrillation discharge paddles away from any conductive parts that might already be in contact with the patient.

**WARNING** Use only accessories approved by Welch Allyn. Visit [www.welchallyn.com](http://www.welchallyn.com). The use of any other accessories can result in inaccurate patient data, can damage the equipment, and can void your product warranty.

**WARNING** Do not operate the monitor in the presence of magnetic resonance imaging (MRI) or hyperbaric chambers.

**WARNING** Do not operate the monitor in the presence of a flammable anesthetic mixture with air, oxygen, or nitrous oxide, or in oxygen-enriched environments, or in any other potentially explosive environment.

**WARNING** It is the clinician's responsibility to set or verify alarm limits appropriate to each patient.

**WARNING** Never allow any liquid to enter any monitor connector. If a connector does come in contact with liquid:

1. Remove the monitor from service.
2. Use warm, dry air to dry the connector.
3. Thoroughly test and verify operation before returning the monitor to service.





**WARNING** Do not connect more than one patient to a monitor.

**WARNING** If the monitor is dropped or damaged, it must be thoroughly tested by a qualified service person before it is returned to service.

**WARNING** Periodically check all cords and cables for damage, wear, or fraying; replace as needed.

**WARNING** The monitor contains no operator-serviceable parts, other than the replaceable paper roll.

**WARNING** If the battery shows any signs of damage, leakage, or cracking, it must be replaced immediately, by a qualified service person, and only with a battery approved by Welch Allyn.

**WARNING** Always recycle batteries according to local regulations. Never dispose of batteries in refuse containers.

**WARNING** Do not use the monitor on patients who are linked to a heart machine or a lung machine.

**WARNING** Do not use the monitor on patients who are experiencing convulsions or tremors.

**WARNING** Do not use the pulse oximeter as a replacement or substitute for ECG-based arrhythmia analysis.

## General Cautions



**Caution** If the accuracy of any measurement is in doubt, verify the patient's vital sign by another method. If the monitor is not measuring accurately, have it inspected by a qualified service person.

**Caution** Be sure that the monitor is securely located on a flat surface or properly suspended by means of appropriate mounting equipment.

**Caution** Do not autoclave the monitor.

**Caution** Do not place cups, glasses, or other fluid containers or vessels on the monitor.

**Caution** Users should check for audible alarm function every time the VSM 300 is used. During the normal power-up cycle, two audible tones are emitted immediately after the self-test is complete. If these tones do not sound, the audio has failed. Remove the device from service and contact Welch Allyn.

The loss of the audible alarm could cause a delay in a clinician learning of an alarm condition for the following conditions: 1) hypotension or hypertension, 2) low blood oxygen content (SpO<sub>2</sub>), 3) low or high pulse rate, 4) other alarm conditions relating to the loss of monitoring of a patient (e.g., a "sensor off" condition). Such delay could potentially result in injury to the patient.

# Displays, Indicators, Controls, and Connections

This section describes the measurement displays, status indicators, function controls, and connections of the monitor.

## Numeric Measurement and Message Displays

### **SYS, DIA, and SpO<sub>2</sub>.**

Displays systolic and diastolic blood pressure and SpO<sub>2</sub>, or related alarm thresholds and error codes. (See "Error Codes" on page 58.)

♥/min  Displays pulse rate and temperature, or related alarm thresholds and error codes.

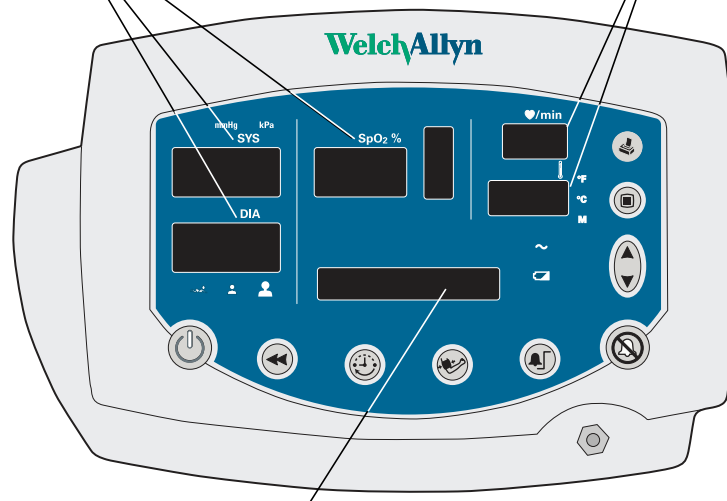

(Message window)

Displays the current date and time, MAP measurements, and alarm thresholds. Displays configuration settings, error codes, software version numbers, and printer status.

# Status Indicators

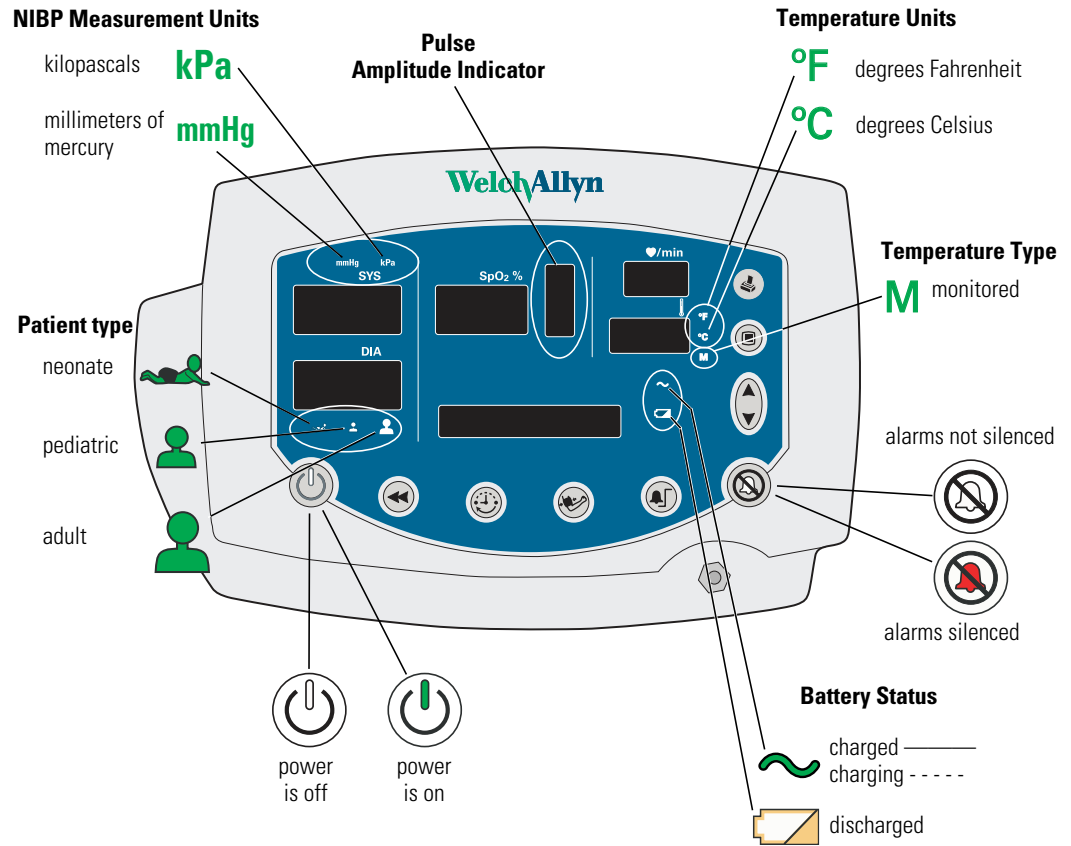

## Function Controls

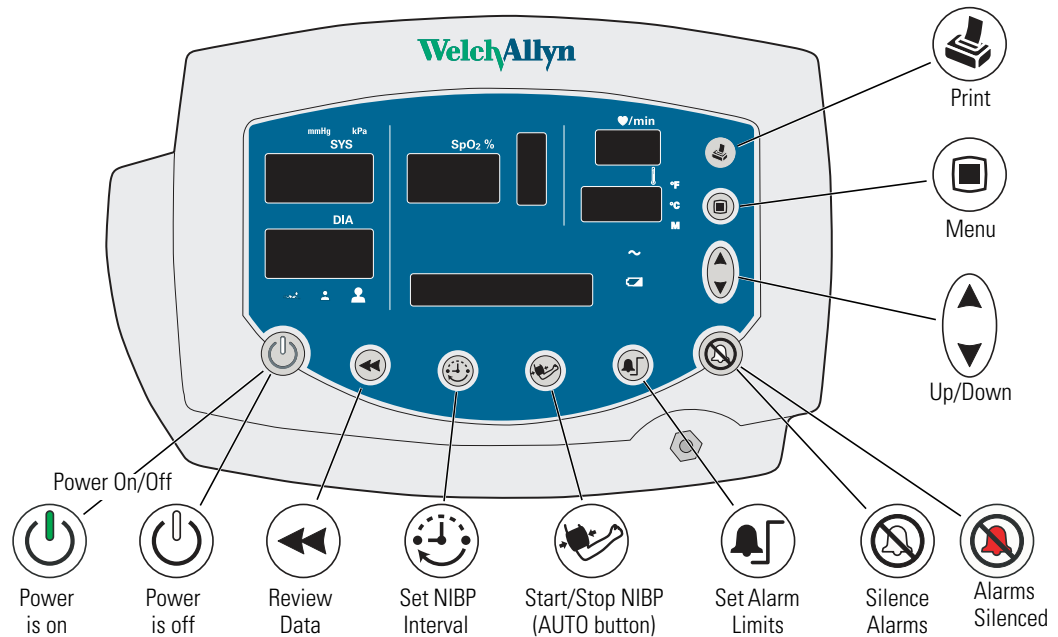

## Connections

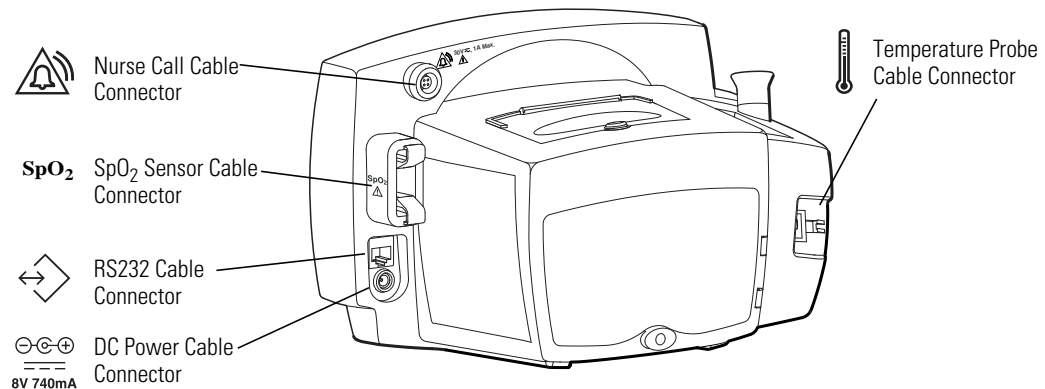

For information on the connections, refer to the following:

<b>AC Power Adapter</b>	"Connecting AC Power" on page 9
<b>Temperature Probe</b>	"Connecting the Temperature Probe Cable" on page 12
<b>SpO<sub>2</sub> Sensor</b>	"Connecting and Disconnecting the SpO <sub>2</sub> Sensor Cable" on page 13
<b>NIBP Cuff Hose</b>	"Connecting the NIBP Cuff Hose" on page 11
<b>Nurse Call Cable</b>	"Nurse Call" on page 79

# 2

## Setup

---

This chapter describes the set-up procedures for patient monitoring.

### Connections

Use the procedures described below to connect components to the monitor.

#### Connecting AC Power

The monitor operates on DC power, supplied by either the internal battery or the AC power adapter. (For information on the battery, refer to “[Battery Operation](#)” on page 69 and “[Electrical](#)” on page 74.)

When the AC power adapter is connected, it simultaneously powers the monitor and charges the internal battery. When the AC power adapter is not connected, the monitor operates on the internal battery.



**WARNING** Use only accessories approved by Welch Allyn. Visit [www.welchallyn.com](http://www.welchallyn.com). The use of any other accessories can result in inaccurate patient data, can damage the equipment, and can void your product warranty.



**Caution** Using an unqualified power adapter can violate isolation requirements.

To use the AC power adapter:

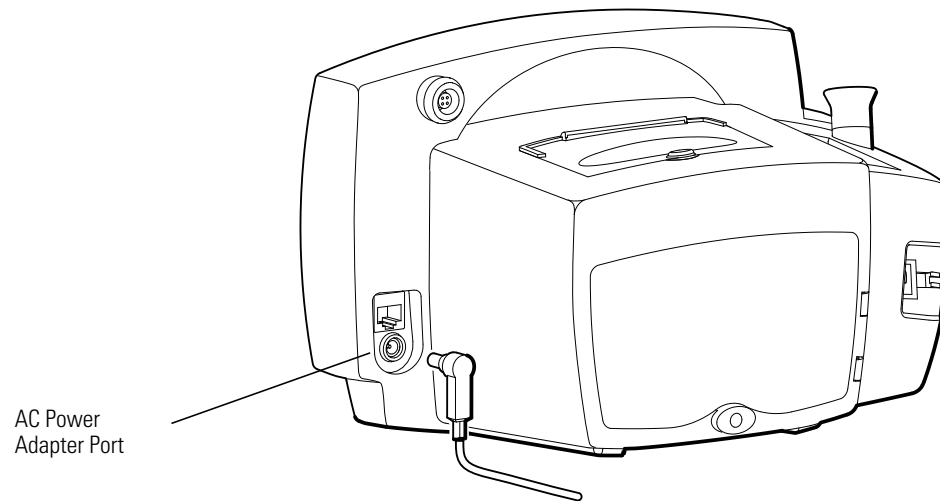

1. Plug the power adapter into the AC power source.
2. Plug the power adapter connector into the monitor DC port.



Use the AC power adapter to fully charge the battery before using the monitor. (This can take up to 12 hours.)



**Caution** Fully charge the battery before using the monitor for the first time. Failure to do so will result in poor battery performance and reduced battery life.

- While the monitor is charging, the AC/charging indicator  flashes.
- When the monitor is 90% charged, the AC/charging indicator  is steady. To fully charge the battery, leave the AC power adapter connected for a few more hours.
- After the monitor is fully charged for the first time, the monitor can be powered by the AC power adapter or by the internal battery.

## Connecting the NIBP Cuff Hose

Attach the hose to the monitor and the cuff as follows, referring to the illustration below:

1. Screw the hose connector onto the NIBP connector on the monitor.
2. Connect the monitor hose connector to the mating connector on the cuff.

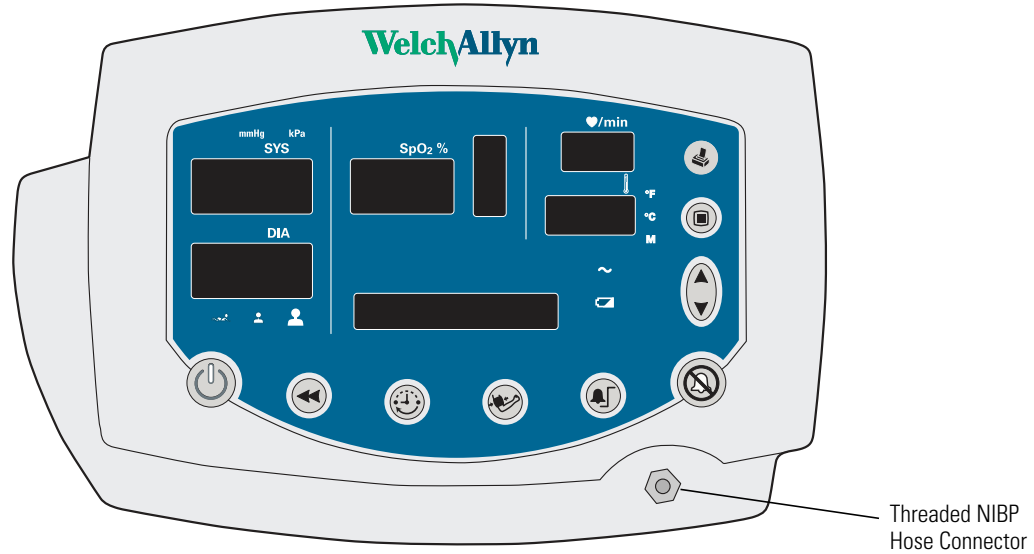

For information on NIBP measurements, see “[Patient Monitoring](#)” on page 29.

## Connecting the Temperature Probe Cable

Follow these steps to connect the temperature probe cable to the monitor.

1. Locate the temperature probe connector port  on the back of the monitor.
2. Holding the temperature probe cable connector with the spring tab on the right, carefully insert it into the monitor temperature probe connector port. The spring tab clicks out when the connector halves are fully and correctly mated.
3. To disconnect the temperature probe cable, depress the spring tab and withdraw the cable connector.

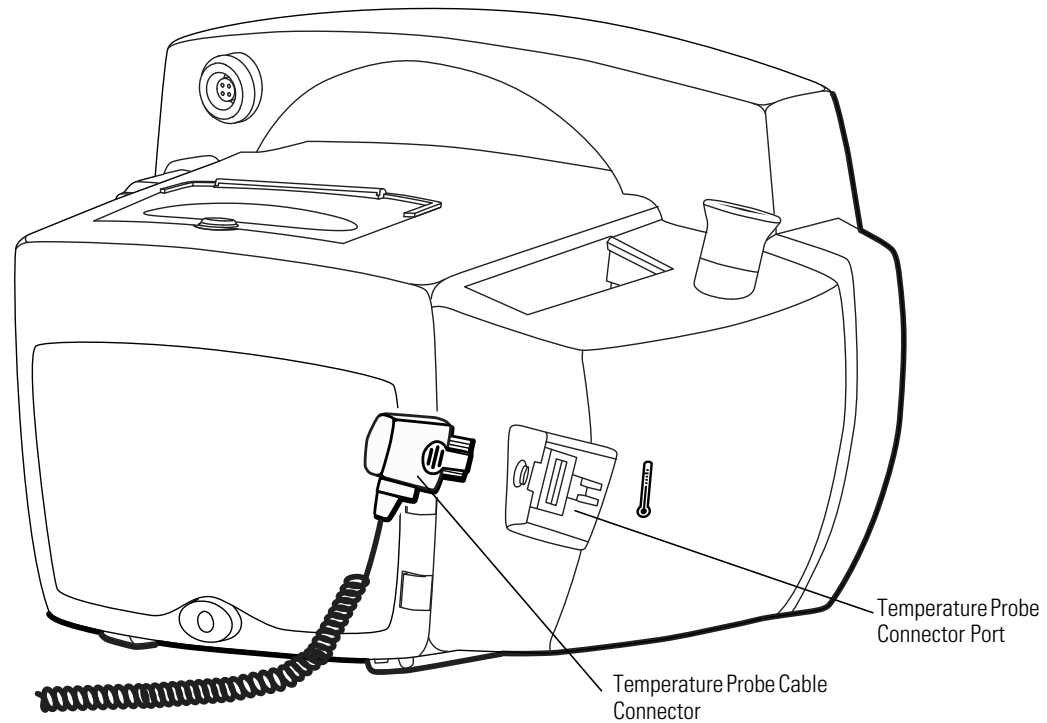

For information on temperature measurements, see [“Patient Monitoring”](#) on page 29.



## Connecting and Disconnecting the SpO<sub>2</sub> Sensor Cable

To connect the SpO<sub>2</sub> sensor cable:

1. Locate the SpO<sub>2</sub> sensor cable connector (labeled **SpO2**) on the side of the monitor.
2. Note the hole patterns of the connector halves, and align the cable connector accordingly.

**Note** Verify that the sensor cable connector has slots on both sides. If the cable connector has a slot on only one side, then the sensor is not compatible with the monitor.

The SpO<sub>2</sub> connectors are notched and flanged to ensure proper fit. If the connectors do not join easily, stop and verify the following:

- You have the correct SpO<sub>2</sub> sensor.
- The cable connector is aligned correctly.

3. Carefully insert the SpO<sub>2</sub> cable connector into the SpO<sub>2</sub> monitor connector.

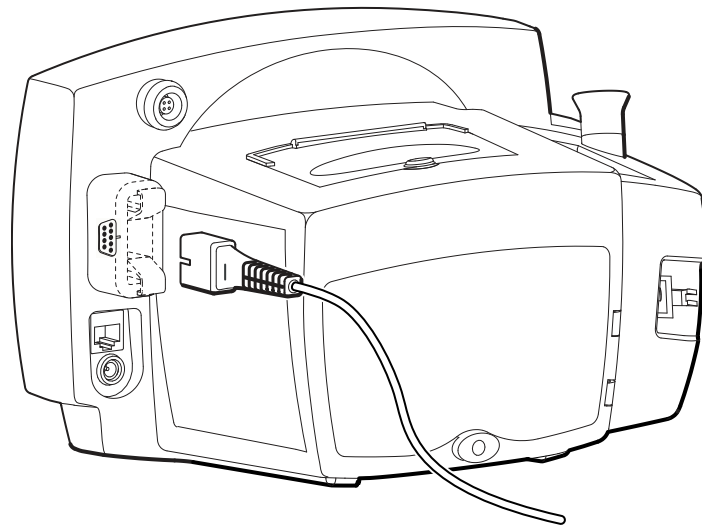

If you are using a sensor extension cable, plug the sensor into the extension cable and plug the extension cable into the monitor.

To disconnect the SpO<sub>2</sub> cable, refer to the instructions shown in the illustration below.

**Note** Always grasp the cable by the connector shoulder. Do not pull on the cable itself.

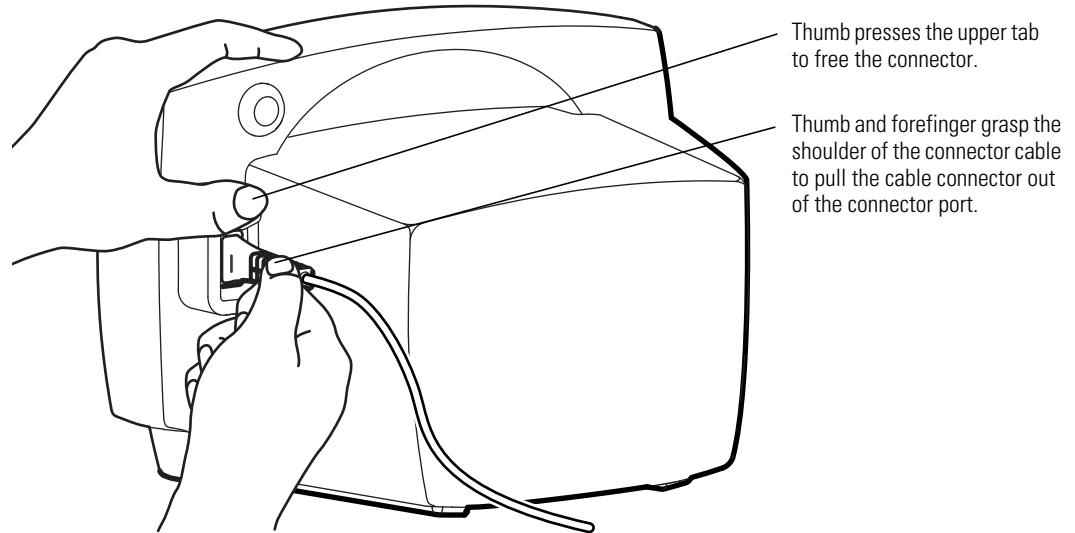

For information on SpO<sub>2</sub> measurements, see ["Patient Monitoring"](#) on page 29.

## Power On, Power-on Self-Test, and Power Off

When the battery is charged, press  to turn on the monitor.

The monitor runs a diagnostic self-test each time it powers up.

- If all tested functions are working normally, the various windows briefly display start-up values ('8' and '- -') and a short tone sounds twice.



**Caution** Users should check for audible alarm function every time the VSM 300 is used. During the normal power-up cycle, two audible tones are emitted immediately after the self-test is complete. If these tones do not sound, the audio has failed. Remove the device from service and contact Welch Allyn.

The loss of the audible alarm could cause a delay in a clinician learning of an alarm condition for the following conditions: 1) hypotension or hypertension, 2) low blood oxygen content (SpO<sub>2</sub>), 3) low or high pulse rate, 4) other alarm conditions relating to the loss of monitoring of a patient (e.g., a "sensor off" condition). Such delay could potentially result in injury to the patient.

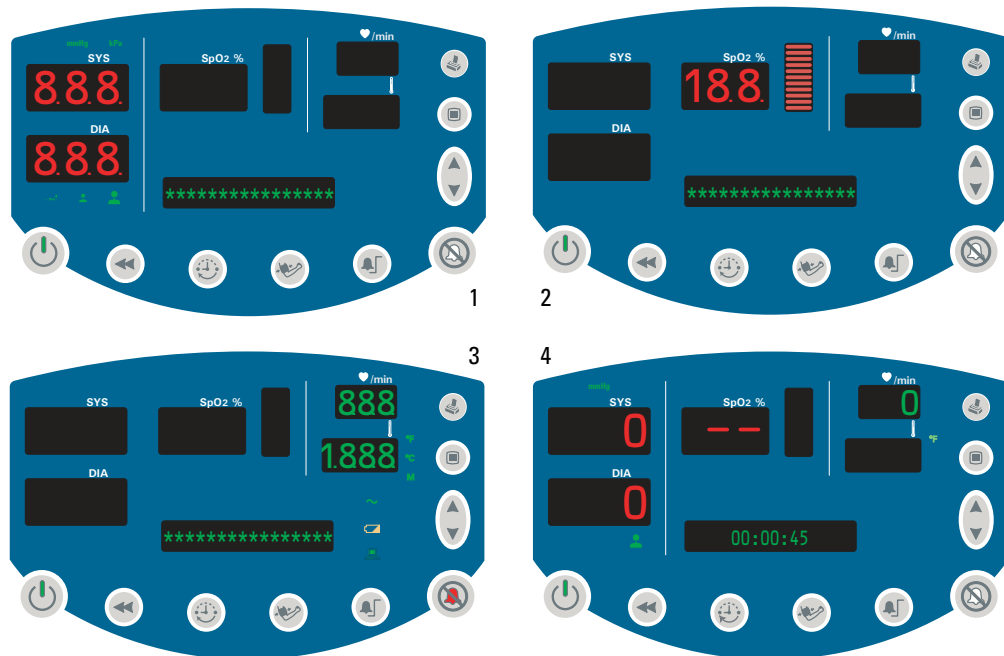

- If the self-test fails, an error code appears in the SYS window.

When the self-test is complete, the software version appears briefly in the message window, followed by the current time of day.



**Caution** Always observe the monitor during power-up. If any display fails to illuminate properly, or if an error code appears in the systolic window, inform your biomedical engineering department immediately, or call your nearest Welch Allyn Customer Service or Technical Support facility. Do not use the monitor until the problem is corrected.

To shut off the monitor, press .

**Note** Shutting off the monitor erases all stored patient data but does not erase settings or configuration parameters.



# Configuring Operating Parameters

You can change several monitor operating parameters. When changed, these settings become the default power-up settings.

## How to Use the Menu System

The monitor menu system contains three sets of menus—settings, configuration, and service.





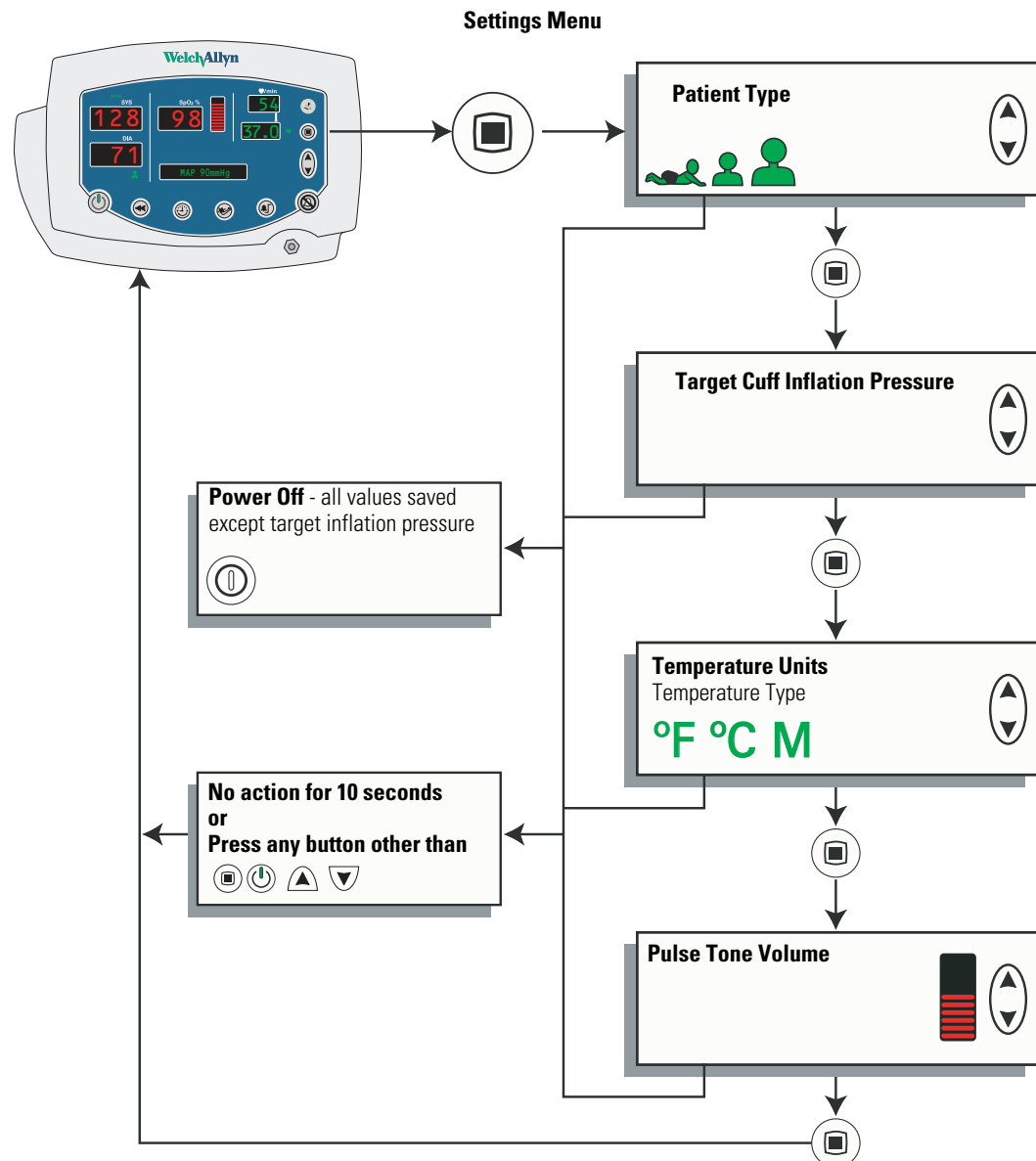

### Settings Menu

Access the settings menu by pressing the menu button  while in normal operation. Then press  repeatedly to reach the setting of interest.









Use the settings menu to select and set the following parameters:

---



Patient Type		Neonate	Term birth through 28 days, or up to 44 gestational weeks
		Pediatric	29 days through 12 years
		Adult	13 years and older
Target Pressure			The initial cuff inflation pressure (set individually for each patient type)
Temp Modes		Fahrenheit Predictive	
		Fahrenheit Monitored	
		Celsius Predictive	
		Celsius Monitored	
Pulse Tone Volume			From 0 (silent) to 5 (loudest)

---

To change a settings parameter:

1. Select the parameter as indicated above.
2. Change the value by pressing  or .
3. Set the displayed new value either by doing nothing for 10 seconds or by pressing any button other than  or . If you press a function button (such as ) , the monitor returns to normal operation with that function () activated.

## Configuration Menu

The configuration menu is accessed by pressing  and keeping it depressed for three seconds. You then press  repeatedly until you reach the setting of interest.

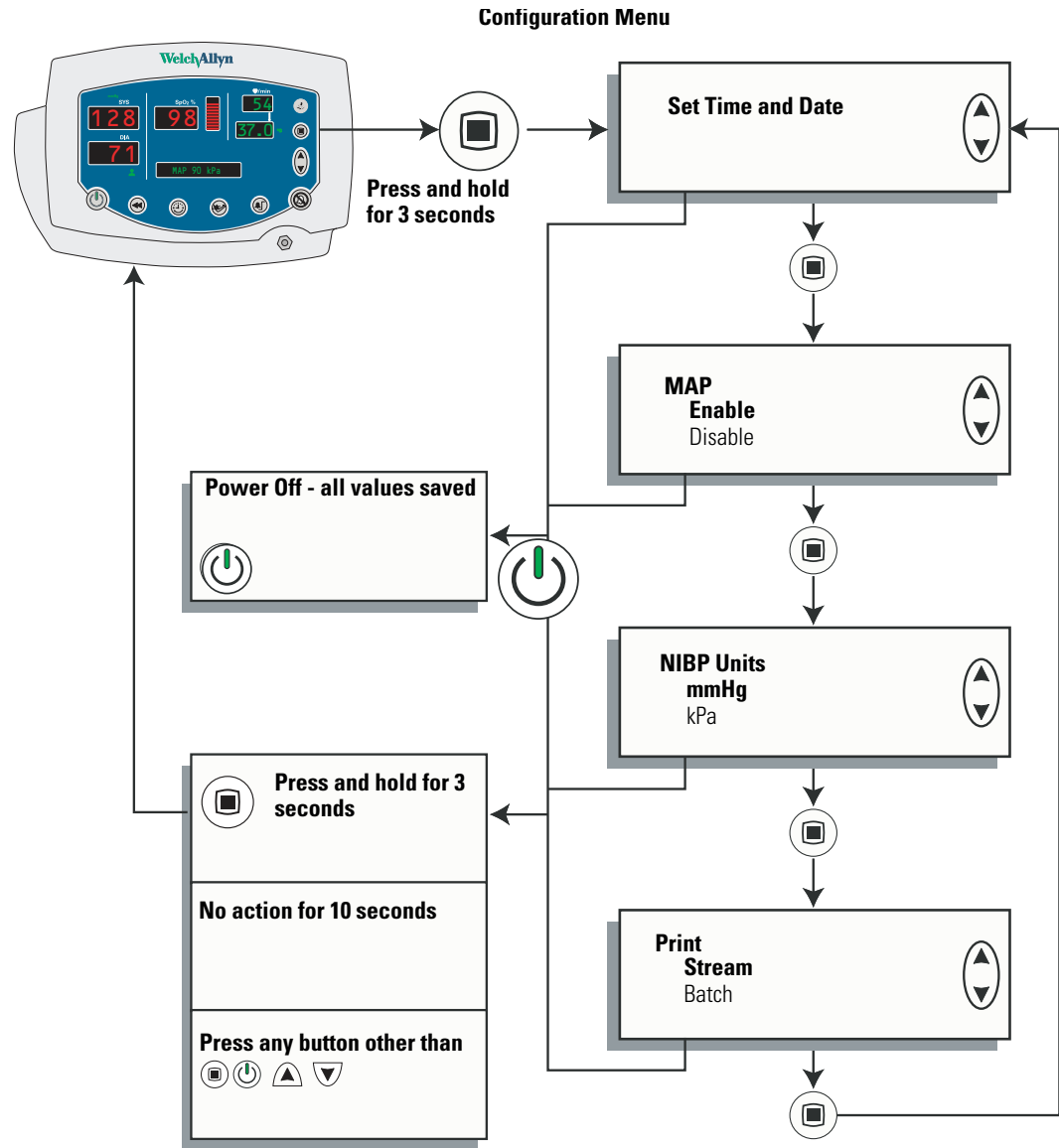







Use the configuration menu to select and set the following parameters:

---

Time and Date	hour minute year month day
MAP Measurement	Enabled Disabled
Blood Pressure Measurement Units	mmHg (millimeters of mercury) kPa (kilopascals)
Print Mode	Batch Stream

---

To change a configuration parameter:









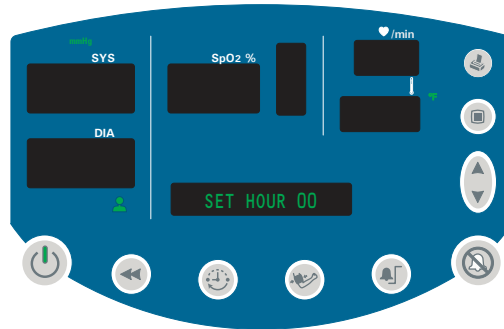





1. Select the parameter as indicated above.
2. Change the value by pressing  or .
3. Set the displayed new value either by doing nothing for 10 seconds or by pressing any button other than  or . If you press a function button (such as ) , the monitor returns to normal operation with that function () activated.

## Changing the Time and Date





Follow these steps to change the time and date settings of the monitor internal clock.

1. Press and hold  for 3 seconds. **SET HOUR XX** appears in the message window.



2. Press  or  as needed to change XX to the current hour.
3. Press  once to set the hours and change the display to **SET MINUTE XX**.
4. Press  or  as needed to change XX to the current minute.
5. Press  once set the minutes and to change the display to **SET YEAR XX**.
6. Press  or  as needed to change XX to the current year.
7. Press  once to set the year and change the display to **SET MONTH XXX**.
8. Press  or  as needed to change XXX to the current month.
9. Press  once to set the month and change the display to **SET DAY XX**.
10. Press  or  as needed to change XX to the current day.



11. To save the displayed time and date settings, either do nothing for 10 seconds or press any button other than  or . If you press a function button (such as ) , the monitor returns to normal operation with that function () activated.

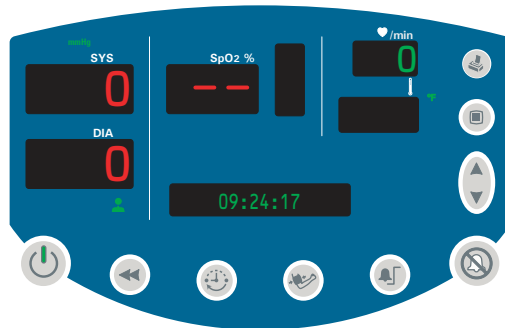

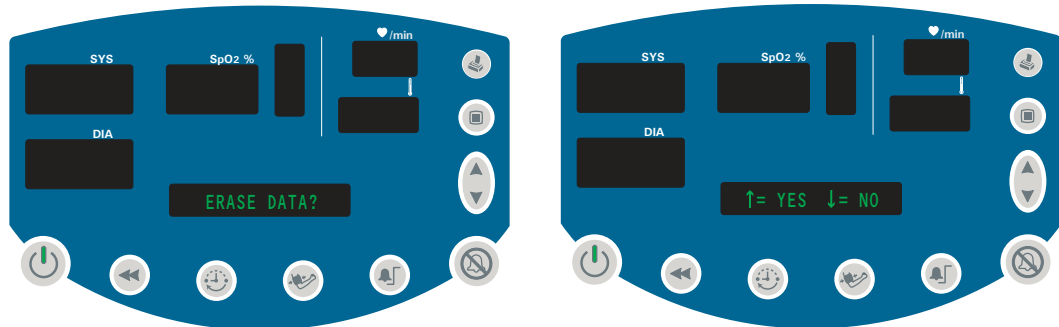

You cannot change the date and time while memory contains stored vital-signs data. If you attempt to change the date and time setting while data is stored, the question **ERASE DATA?** appears in the message window. If you confirm the data erasure, the monitor erases the data from memory and returns you to the date-set function. If you select **NO**, the stored data is retained in memory and the monitor returns to normal operation.















## Changing the Patient Type

The age range for each patient type is defined as follows:

Neonatal		Term birth through 28 days, or up to 44 gestational weeks
Pediatric		29 days through 12 years
Adult		13 years and older

Default setting: **ADULT**.

Follow these steps to change the patient type setting.

1. Press . The current patient type (, , or ) appears below the DIA window, and **NEONATE**, **PEDIATRIC**, or **ADULT** appears in the message window.
2. Press  or  to display , , or .
3. To select the displayed patient type and return to normal operation, either do nothing for 10 seconds or press any button other than  or . If you press a function button (such as ) , the monitor returns to normal operation with that function () activated.

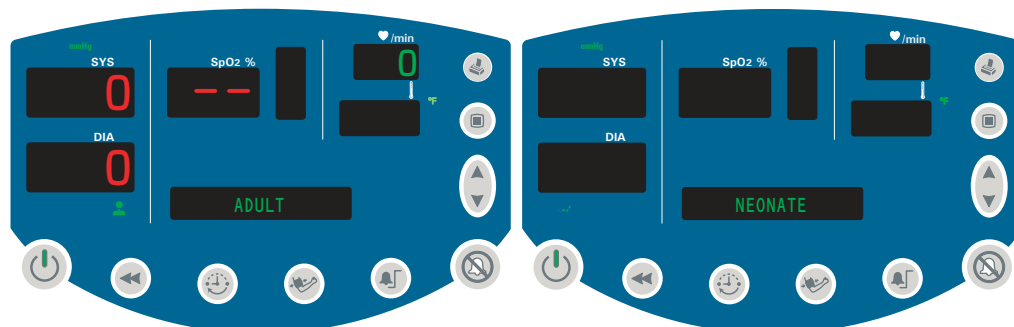



Changing the patient type has the following effects:

- Alarm limits are reset to the default limits for the new patient type
- Cuff inflation target pressure is reset to the default for the new patient type



If you cycle through the patient types but do not change the setting, the alarm limits and the cuff inflation target pressure settings do not change.

## MAP Measurement Enable and Disable



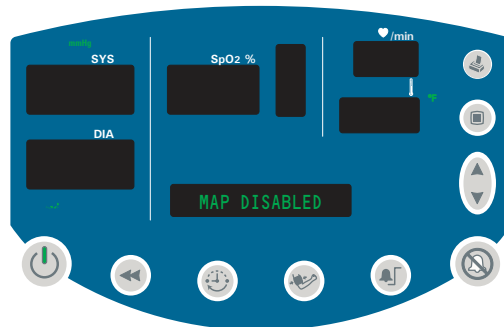

Default setting: **MAP ENABLED** for neonate; **MAP DISABLED** for adult and pediatric.

1. Depress  for 3 seconds. **SET HOUR XX** appears in the message window.
2. Press  repeatedly until **MAP ENABLED** or **MAP DISABLED** appears in the display window.



3. Press  or  to enable or disable MAP measurement.

**Note** If you change the MAP enabled/disabled setting, refer to [“How Changing the Patient Type Affects MAP Defaults”](#) on page 36.

4. To select the displayed state and return to normal operation, either do nothing for 10 seconds or press any button other than  or . If you press a function button (such as ) , the monitor returns to normal operation with that function () activated.

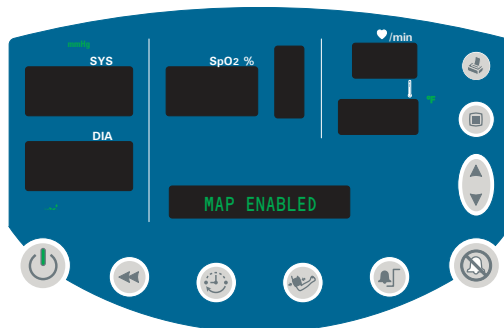



For information about MAP measurements, see [“Patient Monitoring”](#) on page 29.





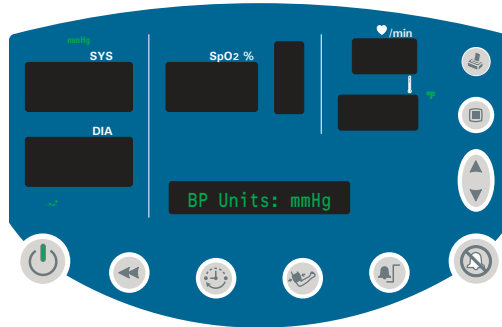

## Changing the NIBP Measurement Units

Default setting: **mmHg**.

To change the NIBP measurement units:

1. Depress  for 3 seconds. **SET HOUR XX** appears in the message window.
2. Press  repeatedly until **BP Units: mmHg** or **BP Units: kPa** appears in the display window.



3. Press  or  as needed to display the desired NIBP measurement units.
4. To select the displayed units and return to normal operation, either do nothing for 10 seconds or press any button other than  or . If you press a function button (such as ) , the monitor returns to normal operation with that function () activated.

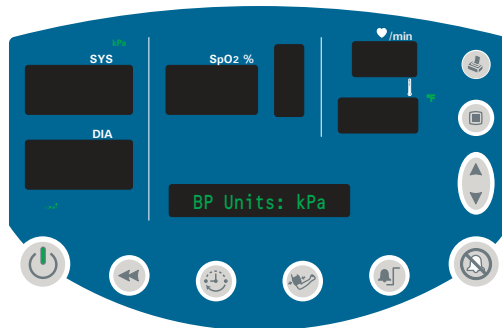

For information on NIBP measurements, see “Patient Monitoring” on page 29.



## Changing Temperature Type and Measurement Units

Default setting: **F** (Fahrenheit predictive).

To change the temperature type and the temperature measurement units:

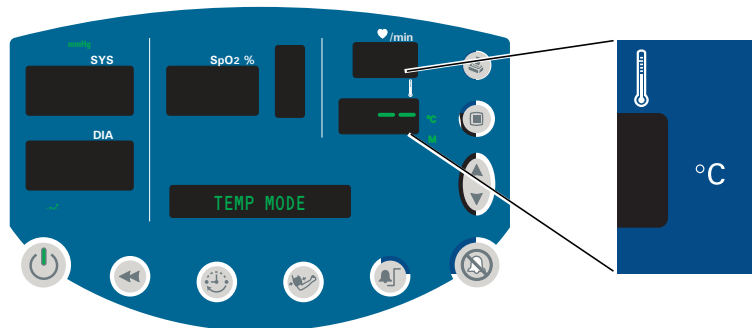



1. With the monitor on, press  repeatedly until **TEMP MODE** appears in the display window. One or two green LEDs to the right of the temperature window illuminate to indicate the selected temperature type.

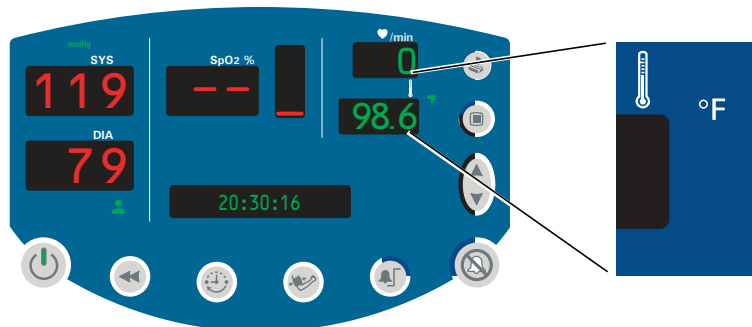

2. Press  or  as needed to cycle to the desired display:

- F** (Fahrenheit Predictive)
- F M** (Fahrenheit Monitored)
- C** (Celsius Predictive)
- C M** (Celsius Monitored)



3. To select the displayed units and return to normal operation, either do nothing for 10 seconds or press any button other than  or . If you press a function button (such as ) the monitor returns to normal operation with that function () activated.

For information on temperature measurements, see “[Patient Monitoring](#)” on page 29.

## Changing the Volume of the Pulse Tone



Default setting: **03**.

The pulse tone can be set from level **00** (volume off) to level **05** (volume on full).



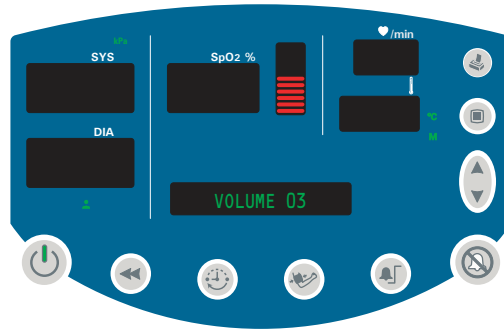

To adjust the volume of the SpO<sub>2</sub> pulse tone, do the following:

1. Press  repeatedly until **VOLUME XX** appears in the display window and the pulse tone sounds continuously.

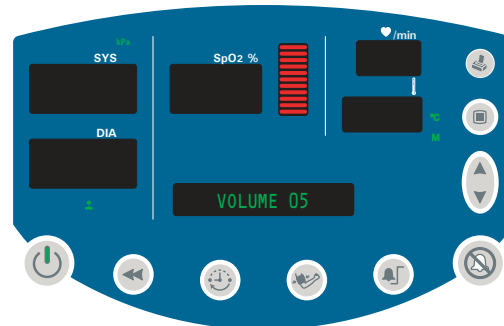

2. Press  or  to raise or lower the volume level.



3. To set the displayed volume level and return to normal operation, either do nothing for 10 seconds or press any button other than  or . If you press a function button (such as , the monitor returns to normal operation with that function () activated.

**Note** Changing the volume of the pulse tone has no effect on the volume of the alarm tones.





**Caution** Users should check for audible pulse tones in conjunction with the SpO<sub>2</sub> function. If these tones do not sound, the audio has failed. Remove the device from service and contact Welch Allyn.

The loss of the audible alarm could cause a delay in a clinician learning of an alarm condition for the following conditions: 1) hypotension or hypertension, 2) low blood oxygen content (SpO<sub>2</sub>), 3) low or high pulse rate, 4) other alarm conditions relating to the loss of monitoring of a patient (e.g., a "sensor off" condition). Such delay could potentially result in injury to the patient.





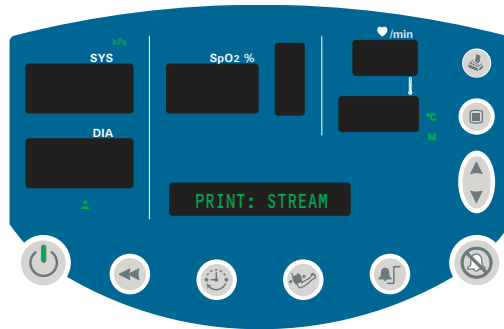

## Selecting Stream or Batch Printing

Default setting: **BATCH**.

For monitors configured with the optional thermal printer:

1. Press  and hold for three seconds.
2. Press  until the message window reads **PRINT: BATCH** or **PRINT: STREAM**.



3. Press  or  to alternate between **PRINT: BATCH** and **PRINT: STREAM** display.
4. To set the displayed printing method and return to normal operation, do nothing for 10 seconds or press any key other than  or . If you press a function button (such as ) , the monitor returns to normal operation with that function () activated.

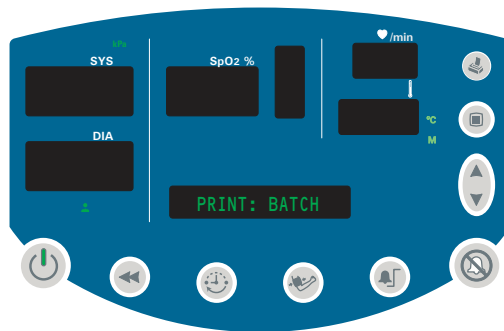

For information on using the printer, see “Patient Monitoring” on page 29.





## 3

## Patient Monitoring

---

### Monitoring Blood Pressure

#### Warnings — NIBP



**WARNING** To ensure safe and accurate NIBP measurements, use only cuffs and hoses approved by or supplied by Welch Allyn.

**WARNING** Never use an adult or pediatric monitor setting or cuff for an NIBP measurement on a neonatal patient. Adult and pediatric inflation limits can be excessive for neonatal patients, even if a neonatal cuff is used.

**WARNING** NIBP readings may be inaccurate for patients experiencing moderate to severe arrhythmia.

**WARNING** When patients are being monitored frequently or monitored for a prolonged period, regularly remove the cuff to inspect it and to inspect the patient's cuffed extremity for ischemia, purpura, or neuropathy.

**WARNING** To avoid the risk of intravenous line misconnection and possible introduction of air into a patient's blood, do not fit the NIBP system with Luer Lock adapters.

**WARNING** Do not place the cuff on an extremity already being used for intravenous infusions or SpO<sub>2</sub> monitoring.

**WARNING** Do not place the cuff where it can affect proper circulation.

**WARNING** NIBP measurements may be inaccurate in the presence of excessive motion artifact.



**Caution** Pulse rate measurements generated through the blood pressure cuff or through SpO<sub>2</sub> are subject to artifact and might not be as accurate as heart rate measurements generated through ECG or through manual palpation.

## NIBP Preparation

Before you start any NIBP measurement, always follow the steps described in these procedures:

- “Changing the Target Pressure” on page 30
- “If the following actions and conditions occur in sequence, monitor behavior is as follows, which differs from what is described in “Changing the Target Pressure” .” on page 30
- “Positioning the Cuff” on page 31





### Changing the Target Pressure

Follow these steps to change the target pressure (default initial pressure for cuff inflation) for the current patient type:

1. Press  until the message window displays **TARGET PRESSURE**.

The SYS window displays the current setting for initial inflation pressure.

2. Press  or  to raise or lower the preset pressure value to the target level.

To set the displayed pressure level and return to normal operation, either do nothing for 10 seconds or press any button other than  or . If you press a function button (such as ) , the monitor returns to normal operation with that function () activated.

**Note** Target pressure is a nominal starting point. If it is too low to take a measurement, the monitor takes another measurement using a higher initial pressure.

If the following actions and conditions occur in sequence, monitor behavior is as follows, which differs from what is described in “Changing the Target Pressure” .

Action 1. You select a **nondefault** target pressure.

Action 2. You start an NIBP measurement.

Condition 1. The pump reaches the target pressure and the pressure starts to bleed off.

Condition 2. The pressure bleed-off is interrupted (motion artifact or NIBP start/stop button press) and the measurement cycle does not complete.

Action 3. You select the **default** target pressure.

Action 4. You restart the NIBP measurement.

Under these conditions, the monitor does not use the default target pressure; instead, it uses the target pressure set in Action 1 above.

- Following a successful NIBP measurement, the monitor adjusts subsequent NIBP attempts to pump up to the lowest target that works.
- Following an unsuccessful measurement, however, the monitor increases target pressure and then pumps up for one, two, or three attempts before it stops.

If Action 1 and Action 2 lead to Condition 1 and Condition 2, do the following to restore the monitor to normal operation:

1. Power the monitor off.
2. Power the monitor on.

Start the blood-pressure measurement using the default target pressure.

### Selecting a Cuff

You can tell whether the cuff size is appropriate by putting the cuff on the patient and then inspecting the fit. If the edge marking lies somewhere between the two range markings, then the fit is correct.

You can also find the correct cuff by measuring the circumference of the patient’s arm at the biceps:

Cuff Size	Circumference (inches)	Circumference (centimeters)	Cuff Size	Circumference (inches)	Circumference (centimeters)
Neonate #1	1.3 - 2.2	3.3 - 5.6	Small Child	4.9 - 6.6	12.4 - 16.8
Neonate #2	1.6 - 2.8	4.2 - 7.1	Child	6.2 - 8.4	15.8 - 21.3
Neonate #3	2.1 - 3.6	5.4 - 9.1	Small Adult	7.9 - 10.6	20.0 - 27.0
Neonate #4	2.4 - 4.6	6.9 - 11.7	Adult	10.0 - 13.5	25.3 - 34.4
Neonate #5	3.5 - 5.9	8.9 - 15.0	Large Adult	12.6 - 17.1	32.1 - 43.4
Infant	3.9 - 5.2	9.8 - 13.3	Thigh	16.0 - 21.7	40.7 - 55.0

### Positioning the Cuff

For the most accurate measurement, do the following:

1. Position the cuff on the bare arm, midway between the shoulder and the elbow.

Typical cuff positions are shown in this illustration:

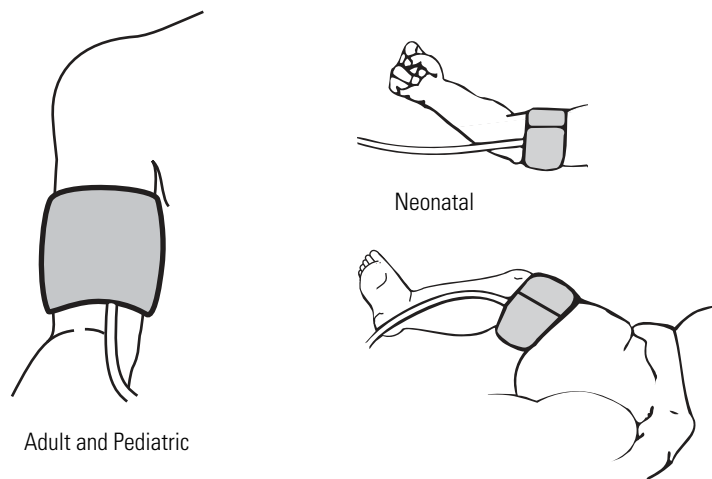

2. Position the alignment mark on the cuff directly over the brachial artery.

**Note** Be sure that the cuff is neither too tight nor too loose. When putting it on the patient, wrap it so that you can comfortably fit two fingers between the cuff and the arm.

Be sure that the air hose has no kinks or twists.

During an NIBP measurement, limit the movement of the cuff and the cuffed extremity.

If the cuff is not level with the heart, add 1.8 mmHg to the displayed reading for each inch of elevation above the heart, or subtract 1.8 mmHg from the displayed reading for each inch of elevation below the heart.

Always use the appropriate cuff size for each patient.

## Manual NIBP Measurement

Follow these steps to take a single NIBP measurement.

1. Attach the cuff to the patient's arm.
2. Press .
  - The monitor inflates the cuff.
  - The SYS window dynamically displays the current cuff pressure.

**Note** If the message 'CAL' appears in the message window when you attempt to start an NIBP cycle, it means that the NIBP measurement system is self-calibrating to a zero baseline and is temporarily unavailable (for up to 30 seconds). The requested NIBP cycle begins when the calibration is complete. However, the cuff must remain stationary for at least 15 seconds for the calibration to complete.

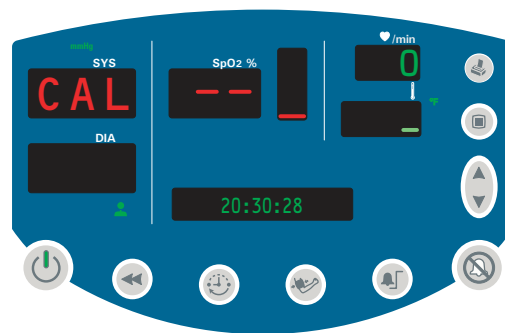

- When the NIBP cycle is completed, a tone sounds and the NIBP measurement results are displayed in the SYS, DIA, and pulse rate windows.

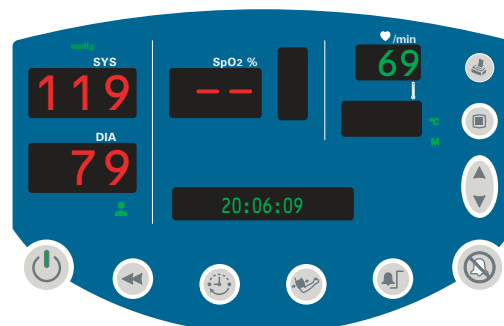

- If MAP is enabled, MAP results are displayed in the message window.

**Note** If the SpO<sub>2</sub> sensor is attached and generating valid pulse rate data, then the displayed pulse rate is derived from the SpO<sub>2</sub> sensor reading.

The measurement display persists for two minutes or until another NIBP cycle is initiated. If an error is detected, an error tone sounds and an error code appears in the SYS window.

## Automatic NIBP Measurement

Automatic NIBP measurements repeat continuously at programmed intervals.



**Note** The interval is the time from the beginning of one measurement cycle to the beginning of the next measurement cycle.

To set up an automatic NIBP measurement, do the following:

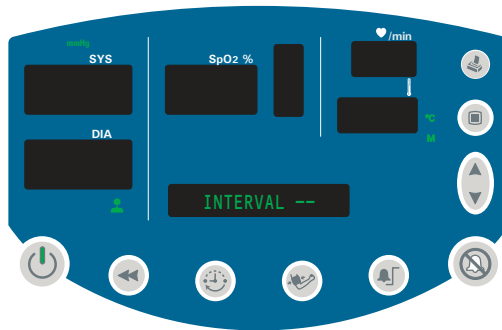

1. Attach the cuff to the patient's arm.
2. Press  to set the measurement interval.

The two dashes (- -) in the message window indicate that automatic measurement is turned off.



3. To set an interval, press  or  to cycle through the options, which include --, ST, and a range of intervals: 1, 3, 4, 5, 10, 15, 30, 45, 60, 90, 120, and 240 minutes.

**Note** The **ST** interval selection works differently from the other intervals. For information on using these settings, please refer to “[STAT Measurement](#)” on page 36.

4. To select the currently displayed interval, press any button other than ,  or .

Ten seconds after you select an interval, and assuming that safe venous return pressure (SVRP) has been maintained for at least 30 seconds, the monitor starts the first automatic NIBP cycle and the following occurs:

- The cuff inflates to the default pressure level.
- The SYS window dynamically displays the current cuff pressure.
- If MAP is enabled, the MAP measurement value alternates with the time display in the message window.

**Note** If a MAP alarm occurs, the MAP is displayed steadily in the message window.

When the NIBP cycle ends, a tone sounds and the monitor displays the measurement results, including pulse rate in the /min window. (If the SpO<sub>2</sub> sensor is attached to the patient, the pulse rate is derived from the SpO<sub>2</sub> sensor.)

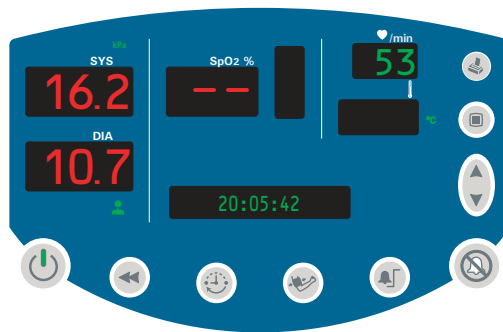

The measurement display persists until one of the following occurs:

- the next cycle begins, if the monitor is still in automatic NIBP mode
- two minutes pass
-  is pressed again

**Note** If the first cycle does not produce a measurement, the monitor retries the measurement using a target pressure calculated from the results of the previous cycle.

The automatic NIBP cycles continue until one of the following occurs:

- The monitor reaches the 5-minute limit for a STAT measurement. (The current cycle continues to completion, even if it goes beyond the 5-minute limit.)
- The monitor halts because  is pressed.
- The monitor halts because of an alarm, alert, or error condition.
- The interval code is changed to '--'.

If an error is detected during the measurement, an error tone sounds and an error code appears in the SYS window.

**Note** The latest NIBP measurement is displayed until one of the following occurs:

- the next NIBP cycle starts
- an alarm, alert, or error occurs
- the monitor shuts down

## MAP Measurement

MAP is available for adult, pediatric, and neonatal patients. The monitor is set at the factory to enable MAP display and alarm limit checking for neonatal patients, and to disable those functions for adult and pediatric patients.

If MAP is enabled, the monitor displays MAP readings in the message window at the end of NIBP measurements.

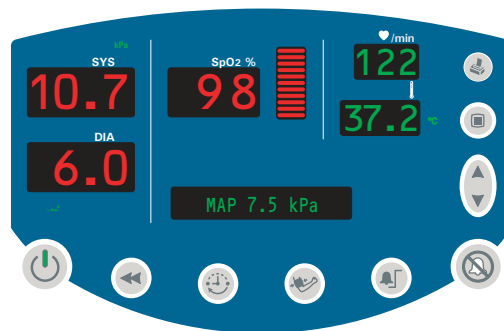

## How Changing the Patient Type Affects MAP Defaults

When you cycle power to the monitor, the monitor stores all current settings before shutting down. It then uses these saved settings when it powers up again. (This does not affect the factory default settings.)

Whenever you enable or disable MAP for a given patient type—Adult, Pediatric, Neonatal—the current enabled/disabled setting becomes the default power-up setting for that patient type.

For example: If the monitor is set to Neonatal and you set MAP Disabled, MAP Disabled becomes the default setting for neonatal patients until you change the enabled/disabled setting again.

## Enabling and Disabling MAP Measurement

See “MAP Measurement Enable and Disable” on page 23.

## STAT Measurement

If the selected interval is STAT, the monitor takes repeated NIBP measurements for 5 minutes, starting a new cycle each time the cuff deflates below safe venous return pressure (SVRP) for two seconds.

Current cuff pressures are not dynamically displayed during a STAT reading. The message window displays the NIBP reading from the previous cycle until the current cycle finishes. (Before the first cycle finishes, the display reads '0'.)

## Monitoring Pulse Rate

The monitor displays the pulse rate at the end of all NIBP or SpO<sub>2</sub> measurements. It displays NIBP pulse information only if no SpO<sub>2</sub> reading is available.

If the SpO<sub>2</sub> sensor is connected to the patient during the measurement period, the pulse amplitude indicator rises and falls in rhythm with the monitored heart rate. The higher the display rises, the stronger the measured pulse; however, the height of the indicator display is not mathematically proportional to the volume of the pulse.



# Monitoring SpO<sub>2</sub>

## Warnings and Cautions — SpO<sub>2</sub>



**WARNING** Always follow the manufacturer's instructions for care and use of the SpO<sub>2</sub> sensor.

**WARNING** The accuracy of the SpO<sub>2</sub> measurement can be affected by any of the following:

- the presence of significant amounts of dysfunctional hemoglobin, such as carboxyhemoglobin or methemoglobin
- the presence of concentrations of some intravascular dyes, sufficient to change the patient's usual arterial pigmentation
- patient movement
- patient conditions such as shivering and smoke inhalation
- painted nails
- poor oxygen perfusion
- anemia or low concentrations of hemoglobin
- hypotension or hypertension
- severe vasoconstriction
- shock or cardiac arrest
- venous pulsations or sudden and significant changes in pulse rate
- proximity to an MRI environment
- moisture in the sensor
- excessive ambient light, especially fluorescent
- wrong sensor or sensor too tight

**WARNING** If there is any question of the accuracy of an SpO<sub>2</sub> measurement, verify the measurement using another clinically accepted measurement method.



**WARNING** Do not use the SpO<sub>2</sub> sensor as an apnea monitor.

**WARNING** During prolonged, continuous SpO<sub>2</sub> monitoring, check the sensor site often, in compliance with the sensor manufacturer's directions. Inspect the patient's skin integrity and circulation, and relocate the sensor if necessary. Tissue damage can result from improper or prolonged sensor attachment.

- Use only sensors and accessories recommended by Welch Allyn.
- Do not use damaged sensors or cables.
- Do not use a sensor with exposed optical components.
- Do not immerse or wet the sensor.



**Caution** Some sensors might not work with some patients. If, after 20 seconds, a properly functioning sensor fails to discern a pulse, do the following:

1. Adjust or reposition the sensor. If the failure continues:
2. Use a different type of sensor.

## SpO<sub>2</sub> Monitoring Procedure

1. Verify that the SpO<sub>2</sub> sensor cable is connected to the monitor.
2. Attach the SpO<sub>2</sub> finger clip sensor to the end of the patient's index finger, as shown below. The sensor can be attached to the patient when the monitor is on or off, and during an NIBP cycle.

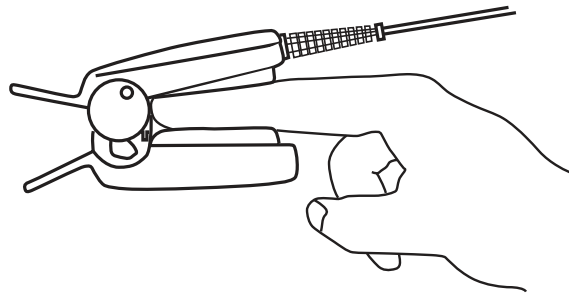

**WARNING** Do not use an SpO<sub>2</sub> finger clip sensor and a blood pressure cuff simultaneously on the same limb. To do so will result in inaccurate pulse rate and perfusion readings, and could cause erroneous pulse rate alarms.

Within a few seconds, the pulse amplitude indicator reflects the rate and strength of the pulse.

Within less than 20 seconds, the SpO<sub>2</sub> window displays the SpO<sub>2</sub> measurement and a numeric pulse rate value appears in ♥/min.

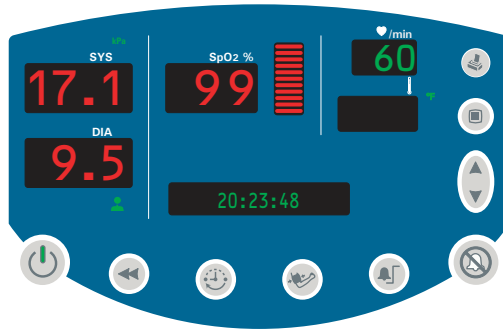

**Note** During an SpO<sub>2</sub> measurement, the displayed pulse rate is derived from the SpO<sub>2</sub> sensor. Otherwise, the pulse rate is derived from NIBP.

Detaching the sensor during an SpO<sub>2</sub> measurement triggers an alarm.

If alarms are set for SpO<sub>2</sub> or pulse rate, a condition of no pulse for between 5 and 10 seconds causes an alarm.

If SpO<sub>2</sub> is being measured continuously on a patient over an extended period, change the location of the sensor at least every three hours or as indicated by the directions supplied with the sensor.

To adjust the volume of the SpO<sub>2</sub> pulse tone, see [“Changing the Volume of the Pulse Tone”](#) on page 26.



**Caution** Users should check for audible pulse tones in conjunction with the SpO<sub>2</sub> function. If these tones do not sound, the audio has failed. Remove the device from service and contact Welch Allyn.

The loss of the audible alarm could cause a delay in a clinician learning of an alarm condition for the following conditions: 1) hypotension or hypertension, 2) low blood oxygen content (SpO<sub>2</sub>), 3) low or high pulse rate, 4) other alarm conditions relating to the loss of monitoring of a patient (e.g., a “sensor off” condition). Such delay could potentially result in injury to the patient.

# Monitoring Temperature

## Warnings and Cautions — Temperature



**WARNING** To ensure patient safety and to obtain accurate and reliable temperature results, read this section thoroughly before using the temperature instrument.

**WARNING** Always put a single-use probe tip cover on the probe tip before taking a temperature measurement. Failure to use a probe tip cover can cause patient discomfort, patient cross-contamination, and erroneous temperature readings.

**WARNING** Use only Welch Allyn single-use disposable probe covers. The use of any other probe cover can cause patient cross-contamination and erroneous temperature readings.

**WARNING** Never re-use a probe cover.

**WARNING** Using a probe at the wrong site produces inaccurate measurements and can cause patient injury.

- Use only oral probes, identified by a blue ejection button at the top of the probe, to take oral and axillary temperatures.
- Use only rectal probes, identified by a red ejection button at the top of the probe, to take rectal temperatures.

**WARNING** Use only the oral probe well with the oral probe, and use only the rectal probe well with the rectal probe. Using the wrong probe well can result in patient cross-contamination.

**WARNING** Always verify direct probe-cover-to-skin contact. Do not take an axillary temperature through the patient's clothing.

**WARNING** Use extreme caution when taking rectal temperatures on children. Insert the probe tip only 3/8-inch (~1 cm) to avoid risk of bowel perforation.

**WARNING** The thermometer case is not waterproof. Do not immerse it in fluids or drip fluids onto it.

**WARNING** The thermometer consists of high-quality precision parts. Protect it from severe impact or shock. Do not use the thermometer if you notice any signs of damage to the probe or the instrument. If the thermometer probe is dropped or damaged, remove it from service and have it inspected by a qualified service person.

**WARNING** Do not use the thermometer for any purpose other than those described in this document. Doing so will invalidate the product warranty.

## Setting the Temperature Measurement Type

The monitor, if configured with the temperature option, can provide both predictive and monitored temperature measurements.

A **predictive measurement** is a one-time measurement that takes only a few seconds. It results in a single temperature reading which is displayed at the end of the brief measurement period. The monitor sounds three short tones to indicate the end of a predictive measurement.

A **monitored measurement** is a continuous temperature monitoring, used when the situation prevents accurate predictive measurement. For oral and rectal measurements, three minutes of monitoring is recommended. For axillary measurements, five minutes of monitoring is recommended.







**WARNING** Do not exceed the recommended measurement periods of 3 minutes for oral and rectal measurements and five minutes for axillary measurements.

During a monitored measurement, the temperature is displayed dynamically throughout the measurement period. Unlike a predictive measurement, the monitor does not indicate the end of any elapsed time for a monitored measurement.

To select the temperature measurement type:

1. Press  repeatedly until **TEMP MODE** appears in the display window.
2. Press  or  to cycle to the option you wish to select:

<b>°F</b>	Fahrenheit predictive	<b>°C</b>	Celsius predictive
<b>°F</b>	Fahrenheit monitored	<b>°C</b>	Celsius monitored
<b>M</b>		<b>M</b>	

3. To set the temperature measurement type and return the monitor to normal operation, do nothing for 10 seconds or press any button other than  or . If you press a function button (such as ) , the monitor returns to normal operation with that function () activated.

## Loading a Probe Cover

1. Holding the probe handle with your thumb and two fingers on the indentations of the probe handle, withdraw the probe from the probe well.
2. Insert the probe into a probe cover and press the probe handle down firmly. The probe handle moves slightly to engage the probe cover.

## Ejecting a Used Probe Cover

Do not touch the used probe cover.

1. Position the probe over an appropriate disposal receptacle.
2. While holding the probe securely, push the probe cover ejector button (blue or red) to remove the probe cover into the disposal receptacle.

## Predictive Temperature Measurement

**Note** Verify that the temperature measurement type is set to predictive.  
(The display is either °F or °C; the letter 'M' is *not* illuminated.)



To set up for predictive temperatures, please refer to the procedure described in [“Changing Temperature Type and Measurement Units”](#) on page 25.

To take a predictive temperature, follow these steps:

## Oral Predictive

When used correctly, the monitor produces an accurate oral temperature measurement in less than 6 seconds.

**Note** For oral temperatures, use only the oral probe (blue ejection button) and the blue probe well.

1. Remove the temperature probe from the probe well.

The temperature probe runs a self-test, displaying **188.8** for a few seconds. When it is ready for use, the temperature window clears, and then **OrL** appears in the temperature window.

2. Load a new probe cover by inserting the probe into a probe cover and pressing the probe handle down firmly. The probe handle moves slightly to engage the probe cover.

 **Caution** Use only Welch Allyn probe covers. The use of any other probe cover, or failing to use a probe cover, can produce measurement errors or inaccuracies.

3. Place the probe tip under the patient's tongue, on either side of the mouth and deep in the rear sublingual pocket.

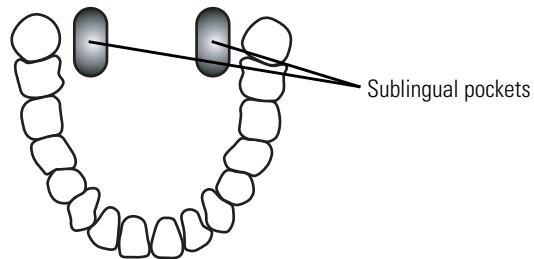

4. Have the patient close his/her lips around the probe.

 **Caution** If the patient bites the probe, the probe can be damaged.

5. Hold the probe in place to assure continuous contact with the oral tissue until the measurement is complete.

Rotating segments appear in the temperature window, indicating that the measurement is in progress.

**Note** The probe must remain in steady contact with the sublingual pocket throughout the measurement period; otherwise, the monitor fails to accurately predict the temperature.

During the measurement period, the temperature window displays a “walking box” — a box with the sides illuminated sequentially. When the temperature prediction is complete, the monitor sounds three short tones and displays the temperature reading, which persists for one minute.

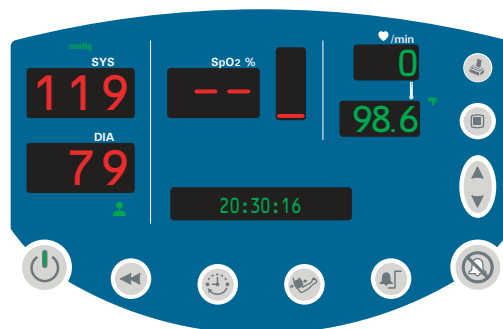

6. Eject the probe cover by pressing the ejection button; hygienically dispose of the probe cover.
7. Return the probe to the probe well.

If the monitor cannot make a predicted measurement within 60 seconds, it switches to monitored temperature measurement and continues to monitor the patient's temperature. (See “[Monitored Temperature Measurement](#)” on page 48.)



**Caution** Do not monitor temperature continuously for more than 5 minutes.

**Note** A probe position error (P) indicates that the probe was moved after making tissue contact. If a probe position error occurs during the temperature determination, the temperature display alternates between the measured temperature and 'P'.



**WARNING** If the probe becomes contaminated, follow the instructions under “[Thermometer and Probe Cleaning Procedure](#)” on page 49.



## Axillary Predictive

When used correctly, the monitor produces an accurate axillary temperature measurement in less than 15 seconds for adults and in less than 13 seconds for pediatric patients.



**Note** For axillary temperatures, use only the oral probe (blue ejection button) and the blue probe well.

Use Axillary Pediatric (**AP**) measurements for patients up to 17 years old.

Use Axillary Adult (**AA**) measurements for patients 18 years old and older.

1. Remove the temperature probe from the probe holder.

The temperature probe runs a self-test, displaying **188.8** for a few seconds. When it is ready for use, the temperature window clears, and then **OrL** appears in the temperature window.

2. Press  or  to change the display to **AP** or **AA**.
3. Load a new probe cover by inserting the probe into a probe cover and pressing the probe handle down firmly. The probe handle moves slightly to engage the probe cover.



**Caution** Use only Welch Allyn probe covers. The use of any other probe cover, or failing to use a probe cover, can produce measurement errors or inaccuracies.

**Note** Be sure that nothing touches the probe tip before you place it in the axillary measurement site.

4. Lift the patient's arm to fully expose the axilla.

**Note** Do not allow the probe tip to make contact with the patient until the probe is placed in the measurement site. Any such contact can cause an inaccurate reading.

5. Place the probe tip as high as possible in the axilla, and then bring the patient's arm down to make maximum contact with the probe tip. Hold the patient's arm in this position, keeping the patient as still as possible, for the duration of the measurement.

**Note** Be sure that the probe tip is fully covered by the axilla and the arm, and that it is not touching any clothing. Do not attempt to take an axillary temperature reading through the patient's clothing.

During the measurement period, the temperature window displays a "walking box" — a box with the sides illuminated sequentially. When the temperature prediction is complete, the monitor briefly sounds a tone and displays the temperature reading, which remains on the display for one minute.

6. Remove the probe from the patient's axilla.
7. Eject the probe cover by pressing the ejection button; hygienically dispose of the probe cover.
8. Return the probe to the probe well.

If the monitor cannot make a predicted measurement within 60 seconds, it switches to making a monitored temperature measurement. (See "[Monitored Temperature Measurement](#)" on page 48.)



**Caution** Do not monitor temperature continuously for more than 5 minutes.

**Note** If a probe position error occurs during the temperature determination, the temperature display alternates between the measured temperature and 'P'.



**WARNING** If the probe becomes contaminated, follow the instructions under "[Thermometer and Probe Cleaning Procedure](#)" on page 49.

## Rectal Predictive

When used correctly, the monitor produces an accurate rectal temperature measurement in less than 13 seconds.

**Note** For rectal temperatures, use only the rectal probe (red ejection button) and the red probe well.

1. Remove the temperature probe from the probe holder.

The temperature probe runs a self-test, displaying '**188.8**' for a few seconds. When it is ready for use, a double tone sounds, the temperature window clears, and then **rEC** appears in the message window.

2. Load a probe cover onto the probe.
3. Apply a thin coat of water-based lubricant to the tip of the probe cover.
4. Separate the patient's buttocks with one hand.
5. Insert the probe tip 1.5 centimeter (5/8-inch) inside the rectal sphincter. Tilt the probe slightly to ensure good tissue contact, and keep the buttocks separated throughout the duration of the measurement.



**WARNING** Use extreme care to avoid any risk of bowel perforation.

During the measurement period, the temperature window displays a "walking box"—a box with the sides illuminated sequentially. When the measurement is complete, the monitor sounds a tone and displays the measurement in the temperature window.

The monitor displays the temperature reading for one minute.

**Note** If a probe position error occurs during the temperature determination, the temperature display alternates between the measured temperature and 'P'.

6. Remove the probe.
7. Eject the probe cover by pressing the ejection button, and hygienically dispose of it.
8. Return the probe to the probe well.



**WARNING** If the probe becomes contaminated, follow the instructions under "[Thermometer and Probe Cleaning Procedure](#)" on page 49.

## Monitored Temperature Measurement



**Caution** Do not monitor temperature continuously for more than 5 minutes.

**Note** Verify that the temperature measurement type is set to monitored. (The letter **M**, to the right of the temperature display window and below **°F** or **°C**, is illuminated.)



The procedures for monitored and predictive temperature measurements are the same, with the following exceptions:

For monitored measurements:

- The monitor must be set to take a monitored temperature. (See [“Changing Temperature Type and Measurement Units”](#) on page 25.)
- The monitor displays the temperature continuously.
- The measurement continues until the probe is replaced in the probe holder.

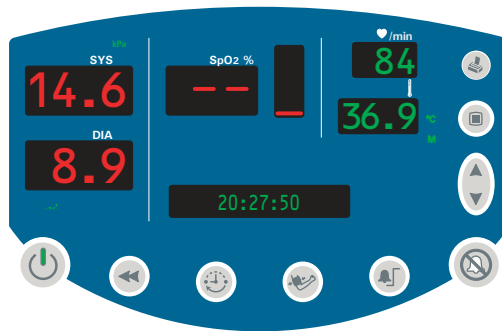

## Thermometer and Probe Cleaning Procedure

1. Wipe the thermometer regularly with a cloth dampened with warm water and a mild detergent solution.
2. Occasionally clean the thermometer and probe as necessary with either a 70% isopropyl alcohol or a 10% solution of chlorine bleach.



**Caution** Do not immerse or soak the thermometer or probe in any type of fluid.

**Caution** Do not use steam, heat, or gas sterilization on the thermometer or probe.

**Caution** Do not autoclave the thermometer or probe.

## Removable Probe Well Cleaning Procedure

1. Remove the probe from the probe well, remove the probe well from the monitor, and unplug the thermometer cable connector from the monitor.
2. Clean the inner and outer surfaces of the probe well by swabbing with a cloth dampened with 70% isopropyl alcohol or a 10% solution of chlorine bleach. The probe well can be immersed during cleaning.



**Caution** Do not use hard, sharp, or abrasive objects to clean the probe well.

**Caution** Do not use steam, heat, or gas sterilization on the probe well.

**Caution** Do not autoclave the probe well.

3. Thoroughly dry all surfaces.
4. Reassemble the thermometer components.
5. Reconnect the thermometer cable to the monitor, making sure it clicks into place.
6. Reinstall the probe well into the monitor.
7. Insert the probe into the probe well.

**Note** You can replace any components of the thermometer, including the probe well.



**WARNING** Use only accessories approved by Welch Allyn. Visit [www.welchallyn.com](http://www.welchallyn.com). The use of any other accessories can result in inaccurate patient data, can damage the equipment, and can void your product warranty.



## 4

## Alarms and Alerts

---



**WARNING** If you turn off any alarm limits while responding to an alarm, verify alarm limits before you resume patient monitoring.

### Responding to a Patient Alarm



**WARNING** If a patient alarm and an equipment alert occur at the same time, take care of the patient alarm first.

A patient alarm occurs when a vital-sign measurement falls outside of programmed limits.

During a patient alarm, the monitor sounds the alarm tone—a repeating series of intermittent short tones—and flashes the associated numerics in the appropriate window. The alarm also activates the Nurse Call relay if the Nurse Call cable is connected.

Respond as follows:

1. Press  to immediately silence the alarm tone.
  - For SpO<sub>2</sub>-related alarms, the alarm resumes 90 seconds later if the alarm condition has not been corrected.
  - For NIBP-related alarms, the alarm is reset.
  - For MAP-related alarms, the MAP measurement readings are displayed in flashing text on the message display.
2. Check the patient and provide appropriate care.

## Responding to an Equipment Alert



**WARNING** If a patient alarm and an equipment alert occur at the same time, take care of the patient alarm first.

### Recoverable Temperature, NIBP, or SpO<sub>2</sub> Alert—Not Escalated

Most recoverable equipment alerts are not escalated to the level of patient alarms. When an unescalated alert occurs, take the necessary steps to correct the equipment problem and then resume patient monitoring.

For an unescalated equipment alert for Temperature, NIBP, or SpO<sub>2</sub>, the monitor does the following:

- Beeps once
- Displays an error code (Cxx) in the relevant window—Temp, SYS, DIA, or SpO<sub>2</sub>

### Recoverable SpO<sub>2</sub> Alert—Escalated

An SpO<sub>2</sub> equipment alert is always escalated immediately to the level of a patient alarm if it occurs when **both** of the following conditions exist:

- SpO<sub>2</sub> monitoring has begun and the monitor has recorded an SpO<sub>2</sub> measurement
- An SpO<sub>2</sub> or Pulse Rate alarm limit has been set

See [“Responding to a Patient Alarm”](#) on page 51.

### Recoverable NIBP Alert—Escalated

An NIBP equipment alert is escalated to the level of a patient alarm whenever both of the following conditions exist:

- Two consecutive NIBP equipment alerts occur while the monitor is taking automatic NIBP/PR measurements
- Alarms are enabled

See [“Responding to a Patient Alarm”](#) on page 51.

**Note** For information about a **battery alert**, see [“Battery Low Warning”](#) on page 69 and [“Battery Failure”](#) on page 69.



## Nonrecoverable Alerts

When the monitor detects a nonrecoverable equipment problem, it does the following

- Displays an error code in the SYS window, and shuts off the display to all other windows
- Stops patient monitoring
- Stops the pump and opens the air valve
- Activates the Nurse Call relay (if connected)
- Produces an audible tone
- Shuts down as soon as  is pressed or one minute has elapsed

### Response

For both recoverable and nonrecoverable equipment alerts, respond as follows:

1. Press  to immediately silence the alert tone.
2. Determine what caused the alert and correct the problem.

## Alarm Indicators

The monitor alarm indicators are as follows:

Event	Audible Indicator	Visual Indicator
<b>Patient Alarm</b>	Three short tones in quick succession, followed by a short silence, and then two short tones in quick succession, followed by a long silence; repeated until action is taken.	Flashing display of the violating value. For a MAP violation, the monitor repeatedly flashes the MAP numerics in the message display.
<b>Equipment Alert, Nonrecoverable</b>	Three short tones in quick succession, followed by a short silence, and then two short tones in quick succession, followed by a long silence; repeated for one minute or until power is shut off.	Flashing display of the violating value for one minute or until power is shut off.
<b>Error</b>	Two short tones	Continuous display of the error code in the appropriate window.
<b>Equipment Alert, Recoverable, NIBP</b>	Two short tones	Continuous display of the error code in the appropriate window.
<b>Equipment Alert, Recoverable, SpO<sub>2</sub>, after valid reading</b>	Two short tones	Flashing display of the last SpO <sub>2</sub> and Pulse Rate, followed in some cases by a Patient Alarm tone.



**Caution** Users should check for audible alarm function every time the VSM 300 is used. During the normal power-up cycle, two audible tones are emitted immediately after the self-test is complete. If these tones do not sound, the audio has failed. Remove the device from service and contact Welch Allyn.

The loss of the audible alarm could cause a delay in a clinician learning of an alarm condition for the following conditions: 1) hypotension or hypertension, 2) low blood oxygen content (SpO<sub>2</sub>), 3) low or high pulse rate, 4) other alarm conditions relating to the loss of monitoring of a patient (e.g., a “sensor off” condition). Such delay could potentially result in injury to the patient.

## Setting Alarms

During patient monitoring, an alarm occurs when a measurement falls outside the programmed alarm limit. Alarms can be set or turned off for the following vital signs:





- Systolic high and systolic low
- Diastolic high and diastolic low
- Pulse rate high and pulse rate low
- SpO<sub>2</sub> high and SpO<sub>2</sub> low
- MAP high and MAP low

**Note** For patient safety, all alarms are reset to the factory default levels whenever the patient type is changed. This means that you must either accept the default alarm limits or set new limits every time you change patient type (👤, 👤, or 👤).

The 'high' alarm for any vital sign is always higher than the 'low' alarm for the same vital sign. For example, the alarm limit for systolic high is always higher than the alarm limit for systolic low.

A reading that exactly reaches the alarm threshold without crossing the alarm threshold does not qualify as an alarm condition.

Set alarms for systolic and diastolic blood pressure, pulse rate, and SpO<sub>2</sub> as follows:

1. Press .
  - All display windows are blanked, other than the message window and the SYS window.
  - The message window displays **HIGH ALARM**.
  - The SYS window displays the current alarm setting for the upper limit of systolic blood pressure. This setting is a numeric blood pressure level or it is '- -', indicating that no alarm is set for the selected vital sign.
2. For the selected vital sign, do one of the following:
  - Leave the limit unchanged or
  - Press  or  as needed to change the limit to another value or to '- -' to disable the alarm.
3. Press  to accept the displayed alarm limit and advance to the next vital sign.
 

The display moves to the next window (for example, from **SYS HIGH** to **SYS LOW**, or from **SYS LOW** to **DIA HIGH**).
4. To continue changing alarm limits, repeat from [step 2](#); to return to normal operation, *do nothing* for 10 seconds.
 

To set the MAP alarm limits, if MAP is enabled:
5. Continue from ([step 3](#)) until you have cycled through all of the display windows; that is, until you have cycled through **SpO<sub>2</sub> LOW**.

The display moves to the message window, which displays the current MAP high alarm limit, as follows:

**MAP ↑ XXX mmHg or MAP ↑ XXX kPa**

**MAP ↓ XXX mmHg or MAP ↓ XXX kPa**

6. Change or accept the MAP high alarm limit as described above (from [step 2](#)).
7. Press  to step to the MAP low alarm limit.
8. Change or accept the MAP low alarm limit.

The range of high and low alarm limits for each vital sign is shown here:

<b>Alarm Limits for Vital Signs</b>			
<b>Vital Sign</b>	<b>Low Limit (Default)</b>	<b>High Limit (Default)</b>	<b>Resolution</b>
<b>Systolic (mmHg)</b>			
Neonatal	30 - 110 (50)	35 - 115 (100)	5 mmHg (0.5 kPa)
Pediatric	35 - 150 (75)	40 - 155 (145)	5 mmHg (0.5 kPa)
Adult	35 - 250 (75)	40 - 255 (220)	5 mmHg (0.5 kPa)
<b>Diastolic (mmHg)</b>			
Neonatal	15 - 95 (30)	20 - 100 (70)	5 mmHg (0.5 kPa)
Pediatric	20 - 120 (35)	25 - 125 (100)	5 mmHg (0.5 kPa)
Adult	25 - 225 (35)	30 - 230 (110)	5 mmHg (0.5 kPa)
<b>Mean Arterial Pressure (mmHg)</b>			
Neonatal	15 - 100 (35)	20 - 105 (80)	5 mmHg (0.5 kPa)
Pediatric	20 - 130 (50)	25 - 135 (110)	5 mmHg (0.5 kPa)
Adult	25 - 245 (50)	30 - 250 (120)	5 mmHg (0.5 kPa)
<b>Pulse Rate (beats per minute)</b>			
Neonatal	35 - 210 (100)	40 - 215 (200)	5 bpm
Pediatric	35 - 210 (50)	40 - 215 (150)	5 bpm
Adult	35 - 210 (50)	40 - 215 (120)	5 bpm
<b>SpO<sub>2</sub> (%)</b>			
Neonatal	50 - 98 (85)	51 - 99 (95)	1%
Pediatric	50 - 98 (85)	51 - 99 (---)	1%
Adult	50 - 98 (85)	51 - 99 (---)	1%

## Nurse Call

The monitor can be connected to a Nurse Call system through a customized cable that connects to the Nurse Call connector. When the cable is connected and operational, the monitor immediately notifies the Nurse Call system when a patient alarm occurs.

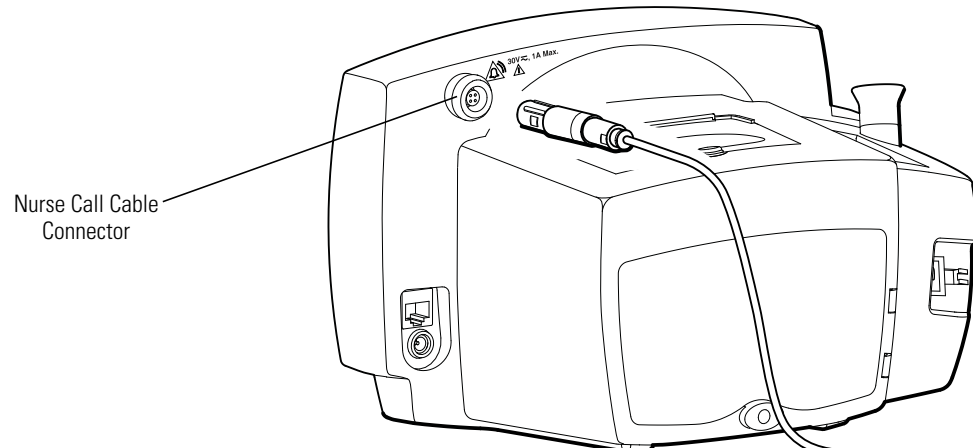

To connect the monitor to a Nurse Call system, you must have a cable (Welch Allyn part number 008-0634-XX or equivalent) that has been adapted to your Nurse Call system. This cable can be built or customized by a biomedical engineering department or other appropriate technical resource, using the specification described on “Nurse Call” on page 79.



**WARNING** Although the Nurse Call option enables remote notification of an alarm condition, it is not intended to replace appropriate bedside patient surveillance by trained clinicians.

**Note** When a patient alarm occurs, pressing  silences the monitor alarm tone and the Nurse Call alarm for 90 seconds, but does not suspend the visual alarm indicator on the monitor.

# Error Codes

<b>Error Code</b>	<b>Description</b>
<b>Blood Pressure</b>	
<b>C01</b>	NIBP cycle cancelled by operator.
<b>C02</b>	Unable to calibrate. Either the cuff is being moved excessively during the calibration or the NIBP unit is not working.
<b>C03</b>	Inflation too rapid. Check for hose constriction. Verify patient type setting.
<b>C04</b>	Inflation too slow. Check for hose leak. Verify patient type setting.
<b>C05</b>	Excessive noise or air leak. Check patient condition, cuff placement and connection. Limit patient motion.
<b>C06</b>	Pressure measurement outside monitor range.
<b>C10</b>	Cuff pressure was too high. Check the patient's condition.
<b>SpO<sub>2</sub></b>	
--	Sensor problem. Check patient condition and sensor position/contact. Verify SpO <sub>2</sub> and pulse rate using an alternative method.
<b>C7</b>	The sensor is broken, missing, or incompatible. Contact customer service.
<b>Temperature</b>	
<b>C20</b>	The probe is broken or missing or the probe well is missing. Contact customer service.
<b>P</b>	The temperature probe has poor tissue contact.
<b>General</b>	
<b>C13</b>	Battery failure. Use the AC power adapter.
<b>E20-E50</b>	Internal failure. Contact customer service.







# 5

## Reviewing Patient Data

---

You can review stored patient data either by viewing it on the monitor or by printing it.

### Displaying Stored Patient Data



1. Press  to display the most recent stored set of patient vital-signs data.
  - The monitor interrupts the dynamic display of any current vital-sign measurement.
  - The message **READING** appears in the message window, with a data-set sequence number and the time of the displayed reading. (During a patient data review, if MAP is enabled, this display alternates every two seconds with the MAP display.)
2. Press  or  to cycle through the stored measurement data sets. (The monitor stores 99 measurement cycles.)
3. To return to normal operation, press any button other than  or . If you press a function button (such as ) , the monitor returns to normal operation with that function () activated.

### Printing Patient Data

**Note** The information in this section pertains only to monitors configured with the optional thermal printer.

The printer provides a way to view and save patient vital-signs data. It can be configured to print all stored data as a single batch or to print a continuing stream of data as the data is recorded in memory. (See [“Selecting Stream or Batch Printing”](#) on page 27.)



## To Start and Stop Printing

- If the monitor is not printing, press  to start printing.
- If the monitor is printing, press  to stop printing. (If the monitor is set to Stream printing, the printer prints a footer before stopping.)

**Note** The print button is not enabled during an NIBP cycle or during a nonrecoverable equipment alert.

## Batch Printing

After a patient has been continuously monitored over some period, a clinician can use the monitor's **batch** printing capability to print all of the measurements that were stored in the monitor's memory over the monitoring period.

When the monitor is configured for batch printing, and while it is in normal operating mode, press  to print all readings stored in memory (up to 99 cycles), starting with the oldest measurement cycle and working forward. The message **PRINTING** is displayed during the batch print, and all monitor controls other than  and  are disabled. Batch printing continues until one of the following occurs:

- All stored data has been printed.
-  is pressed again.
- A battery failure condition.
- A nonrecoverable error condition is detected.

In any of these cases, printing stops immediately.

**Note** If the monitor is configured for **Stream** printing but printing is disabled, you can press and hold  for 3 seconds to immediately start a **Batch** print job. When this **Batch** job ends, the monitor is still configured for **Stream** printing.

## Stream Printing

Alternatively, a clinician can choose to print a continuous **stream** of vital signs, where the measurement information is printed as soon as the results of each cycle are recorded.

When the monitor is configured for stream printing, and while it is in normal operating mode, press  to immediately begin stream printing. Stream printing continues until one of the following occurs:



-  is pressed again; the monitor prints an error log (if any errors occurred) and a footer, and then printing stops.
- A nonrecoverable error condition is detected; printing stops immediately.
- A battery failure condition is detected. Printing is suspended as long as the battery failure continues; if the AC power adapter is connected before the monitor shuts down, printing resumes.

## Printer Output

The printer standard report consists of a header, patient information, patient data (table heading, date, time, range and alarm flags, and measurement readings), an error legend and a footer. If the monitor receives a print request and no data is available, it prints only the header and footer.

### Header

```
|          (R)Welch Allyn          |
|  Vital Signs Monitor          |
|                               |
```

### Patient Information

```
| Patient Name: _____ |
| Patient ID:  _____ |
| Physician:  _____ |
| Procedure:  _____ |
| Comments:  _____ |
| _____ |
| _____ |
| _____ |
```

### Patient Data

The contents of the Patient Data block reflect the configuration of the monitor; that is, with or without the SpO<sub>2</sub> option and with or without the temperature option.

For a single cycle, all data except temperature is printed on one line; the temperature data, if it exists, is printed on a second line. If the data for a single parameter is not available, nothing is printed in the space provided for that parameter.

The patient data is displayed in a table consisting of a table heading, the current date, and rows of patient vital-sign data.

## Table Heading

The Table Heading contains some or all of the following column headings (depending on monitor configuration):

```
| Time Sys Dia MAP PR SpO2 |
| ---- mmHg ---- BPM % |
| ----- |
or
```

```
| Time Sys Dia MAP PR SpO2 |
| ---- kPa ---- BPM % |
| ----- |
or
```

```
| Time Sys Dia MAP PR |
| ---- kPa ---- BPM % |
| ----- |
or
```

```
| Time Sys Dia MAP PR |
| ---- mmHg ---- BPM % |
| ----- |
```

## Date

```
| DD-MMM-YYYY |
```

## Time

The recording time is printed for each record, in the form **hh:mm** (using a 24-hour clock), at the beginning of the first line of the record.

In the illustration below, the first record (21:45) contains systolic and diastolic pressure, MAP, pulse rate, and SpO2 readings; the second record (21:52) contains systolic and diastolic pressure, MAP, pulse rate, and temperature; and the third record (22:12) contains only a temperature reading. When temperature is the only recorded vital sign, the time is printed on the same row as the temperature reading.

```
| Time Sys Dia MAP PR SpO2 |
| ---- mmHg ---- BPM % |
| ----- |
| 21:45 125 69↓ 90 72 98 |
| 21:52 125 69↓ 90 72 98 |
| Temp 99.2F NOR/ORL |
| 22:12 Temp 110.0F↑ NOR/ORL |
```

## Range and Alarm Flags

Flag characters (↑ and ↓) indicate a data value that falls outside of a defined range or violates a programmed alarm threshold. In the illustration above, 69↓ indicates a diastolic pressure value below the programmed alarm limit, and 110.0F↑ indicates a temperature value above the monitor's temperature measurement limit.

## Temperature

The temperature notation includes information about the type and location of the measurement, and can include error notation:

<b>Type</b>			
<b>F</b>	Fahrenheit	<b>C</b>	Celsius
<b>NOR</b>	Normal (predictive)	<b>MON</b>	Monitored
<b>Location</b>			
<b>OrL</b>	Oral	(Oral probe)	
<b>AP</b>	Axillary Pediatric	(Oral probe)	
<b>AA</b>	Axillary Adult	(Oral probe)	
<b>rEC</b>	Rectal	(Rectal probe)	
<b>Error</b>			
<b>(P)</b>	Discontinuity in tissue contact during the measurement period. The displayed temperature measurement is not necessarily accurate.		
<b>C20</b>	Broken or missing temperature probe.		

## Pulse Rate

The pulse rate notation does not include error information.

## SpO<sub>2</sub>

SpO<sub>2</sub> notation can include error information:

<b>C7</b>	Malfunctioning sensor.
--	Sensor error.

## NIBP

NIBP notation can include error information:

---

<b>C01</b>	NIBP cycle cancelled by operator.
<b>C02</b>	Unable to calibrate.
<b>C03</b>	Cuff inflation too rapid.
<b>C04</b>	Excessive cuff inflation time.
<b>C05</b>	Excessive noise or air leak.
<b>C06</b>	Measurement out of range.
<b>C10</b>	Cuff overpressure.

---

## Error Legend

If any error indicators appear in the printed data, the monitor prints an error legend. The error legend contains a two-line header followed by a brief explanation of each error type encountered in the data. The illustration below shows the error legend for a batch of data containing at least one temperature **(P)** error, at least one NIBP **C04** error, and no other errors.

```
| Error Codes:           |
| -----             |
| (P) Loss of tissue contact |
| C04 Excessive inflation time |
|                       |
```

## Footer

The printout footer consists of a line containing the monitor serial number, a line containing the monitor software version, two separator lines, and four blank lines:

```
| Unit S/N: JA736455    |
| S/W Ver.: 1.00.00 00005 |
| -----             |
| -----             |
|                       |
|                       |
|                       |
|                       |
```

## Erasing Patient Data

All patient vital-sign data is erased when the monitor is powered off or when you change the time and date settings. You can also erase data at any time during normal monitor operation.





### Erasing Data Before Changing the Date and Time

If you attempt to change the date and time, the monitor prompts you to confirm that you also want to erase all stored patient data.

**Note** You cannot change the date and time without also erasing all stored patient data.

To erase patient data, press ; the monitor erases the data and enables the date/time adjustment. (For information on changing the time and date settings, see “[Changing the Time and Date](#)” on page 20.)

### Erasing Data During Normal Operation

To erase patient data during normal operation, press and hold  for three seconds. When the monitor prompts for confirmation, press  to confirm or  to cancel. When the erasure is complete, the monitor returns automatically to normal operation. If you cancel the erasure, you can then press any button other than  or  to return to normal operation.

## Replacing the Printer Paper Supply

**Note** Use only the thermal paper (part number 7052-25) supplied by Welch Allyn. The use of any other paper can result in poor printer performance.

To replace the printer paper supply, follow these steps.

1. Press  to open the printer door.
2. Insert a new roll of paper.

**Note** The paper roll must be installed as shown in the illustration below. If the paper roll is not installed correctly, the printer will not print.

3. Thread the end of the roll over the roller and through the slot in the printer door, as shown.

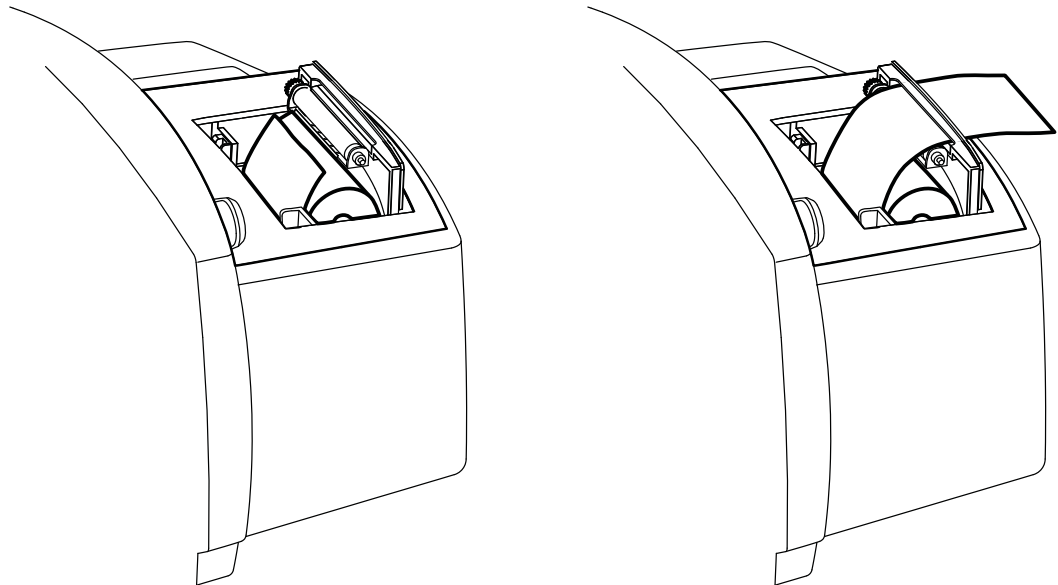

4. With one hand, pull lightly on the paper to take up any slack. With the other hand, close the printer door by pushing it down and into place until it clicks.

**Note** Be certain that the paper does not catch in the printer door.

# 6

## Operator Maintenance

---

This chapter describes the operator maintenance procedures.

### Cleaning

Wipe the monitor with a cloth **slightly dampened** with warm water and a mild detergent or appropriately diluted, nonstaining disinfectant solution.



**Caution** Never wet the monitor or immerse it in fluid of any kind. Never allow water to enter any connector ports.

**Caution** Never immerse any monitor components, such as the NIBP hose or cuff, the temperature probe, or the SpO<sub>2</sub> sensor.

Wipe the temperature probe with a cloth dampened with alcohol, warm water, or an appropriately diluted, nonstaining disinfectant solution.

NIBP hose and any reusable cuffs: See the manufacturer's instructions.

SpO<sub>2</sub> sensor: See the manufacturer's instructions.

### Storage

For maximum monitor life and optimum performance, store the monitor at room temperature in a dry environment.

For prolonged storage, keep the monitor in the original container or in some other dust-proof container.

Before storing the monitor, verify that the printer contains paper.

# Recycling Monitor Components

## Within the EU

Do not dispose of this product as 'unsorted municipal waste'. Prepare it for reuse or separate collection as specified by Directive 2002/96/EC of the European Parliament and the Council of the European Union on Waste Electronic and Electrical Equipment (WEEE).



**Note** If the monitor or the battery is contaminated, this directive does not apply.

For more specific disposal information, see [www.welchallyn.com/weee](http://www.welchallyn.com/weee), or contact Welch Allyn Customer Service.

## Outside the EU

When the monitor or the battery reaches end of life, recycle it locally according to national, state, and local regulations, or return it to Welch Allyn.





# 7 Reference

---

## Battery Operation

### Battery Low Warning



When the battery charge is low, a warning tone sounds and the Low Battery indicator  flashes continuously. From the time  comes on, the battery has enough charge remaining to perform at least one of the following over the next hour:

- 20 NIBP cycles
- 30 minutes of SpO<sub>2</sub> monitoring
- 20 predictive temperature determinations
- a single printing of 99 stored data sets

To avoid a shutdown of the monitor due to battery failure, plug in and connect the AC power adapter.

### Battery Failure

If the monitor continues to run on battery power after  comes on, the battery eventually fails. Battery failure is indicated by the following:

-  flashes continuously.
- A short tone repeats continuously. Pressing  does not suppress this tone.
- The message **LOW BATTERY** is displayed in the message window.
- An error code is displayed in the systolic window (SYS) for 10 seconds, and then all monitor displays are blanked.
- An error signal—2 short tones—sounds once.

Battery failure causes the immediate suspension of all monitoring and print functions. If the wall charger is not plugged in, then the monitor shuts off 15 minutes after the battery discharge reaches failure level. If automatic NIBP is selected, and if the wall charger is plugged in before the monitor shuts down, then automatic measurement cycles resume as soon as the battery voltage rises above the failure threshold.

## Battery Replacement

When the battery has reached end of life, replace it with an identical battery from Welch Allyn (reorder number 501-0015-XX).



**Caution** Always recycle batteries according to local regulations. Never dispose of batteries in waste receptacles.

# Monitor Specifications

The monitor is an FDA Class II non-critical device and, according to Council Directive 93/42/EEG, Annex IX, a Class IIB device.

## Performance

Characteristic	Specification	
	<b>General</b>	
Recovery from Defibrillation Discharge	Per IEC 60606-2-30:1999(E) The monitor returns to normal function within 1 minute after the discharge of a cardiac defibrillator. (Actual recovery time = 0 seconds)	
	<b>NIBP</b>	
Cuff Pressure Range	0 to 300 mmHg (0 to 40 kPa)	
Initial Cuff Inflation	Adult	160 mmHg (21.3 kPa)
Factory Default	Pediatric	120 mmHg (16 kPa)
	Neonate	90 mmHg (12 kPa)
Blood Pressure Accuracy	<ul style="list-style-type: none"> <li>Blood pressure measurement meets or exceeds ANSI/AAMI SP10: 2002 for manual, electronic, or automated sphygmomanometers.</li> <li>Blood pressure accuracy is validated for pressure measurement using the upper arm only, with the patient seated.</li> <li>Blood pressure is validated against manual auscultatory readings for adults and children older than 3 years.</li> <li>Blood pressure is validated against intra-arterial readings for children 3 years and younger.</li> </ul>	
Blood Pressure Determination Time	20 - 45 seconds typical; 165 seconds maximum.	
Overpressure Cutoff	295 to 330 mmHg (39.3 to 44 kPa)	
Systolic Range	Adult	30 to 260 mmHg (4 to 34.5 kPa)
	Pediatric	30 to 160 mmHg (4 to x 21.3 kPa)
	Neonate	25 to 120 mmHg (3.3 to 16 kPa)
Diastolic Range	Adult	20 to 235 mmHg (2.7 to 31.3 kPa)
	Pediatric	15 to 130 mmHg (2 to 17.3 kPa)
	Neonate	10 to 105 mmHg (1.3 to 14 kPa)
MAP	Adult	20 to 255 mmHg (2.7 to 30 kPa)
	Pediatric	15 to 140 mmHg (2 to 18.7 kPa)
	Neonate	10 to 110 mmHg (1.3 to 14.7 kPa)
Pulse Rate Range	30 to 220 bpm	
Pulse Rate Accuracy	± 3 bpm or 3%	

**Note** NIBP specifications are tested by Welch Allyn using the BIO-TEK BP Pump NIBP Monitor Tester.

Characteristic	Specification			Notes
<b>Temperature</b>				
Temperature	80 °F to 110 °F			
Measurement Range	26.7 °C to 43.3 °C			
Temperature Calibration Accuracy	± 0.2 °F (± 0.1 °C); meets or exceeds ASTM E1112-00; EN12470-3:2000			
Temperature Determination Time	predictive (typical)	oral		4 seconds
		axillary		10 seconds
		rectal		15 seconds
<b>SpO<sub>2</sub></b>				
Characteristic	Specification			Notes
				All sensors have a measurement range of 70% - 100%. SpO <sub>2</sub> complies with EN ISO 9919:2005.
Saturation (% SpO <sub>2</sub> )				
Range	1% to 100%, but limited by sensors and by sensor manufacturers' technology			
Resolution	1%			
Alarm limits	50% to 98% (lower) 52% to 100% (upper)			
Probe accuracy (adult, pediatric, neonate)	Accuracy for saturation levels below 70% is unspecified.			
Pulse rate alarm limits	25 to 298 beats/min (lower) 27 to 300 beats/min (upper)			
Pulse rate accuracy	± 3 beats/min typical; varies with sensor model			
Display update interval at the monitor	1 second			
Alarm hold-off period	10 seconds; resets if the sensor reports levels within limits before 10 seconds elapses.			
Circuitry	Microprocessor controlled Automatic self-test of oximeter when powered on Automatic setting of default parameters Automatic alarm messages			
Electrosurgery interference suppression	Yes			
Sensor compatibility	For a complete list of compatible sensors refer to <a href="http://www.welchallyn.com">www.welchallyn.com</a> .			
Nellcor	For probe/sensor compliance to EN ISO 9919:2005, see the Nellcor directions for use.			
Sensor lights (Nellcor)				
Red wavelength	660 nm (nominal), 31.3 mW (max)			
Infrared wavelength	920 nm (nominal), 28.8 mW (max)			
Risk mitigation: Software in this device is developed under the FDA guidance of Part 802.3 design controls and the international standard EN 14971 risk management. These mitigate and minimize any risk associated with potential software errors to a level as low as reasonably possible (ALARP).				

**Note** SpO<sub>2</sub> specifications are published by the SpO<sub>2</sub> component manufacturer and tested by Welch Allyn using the BIO-TEK Index 2 SpO<sub>2</sub> simulator.

## Physical

<b>Characteristic</b>	<b>Specification</b>	
Dimensions		
height	6.6 inches	16.8 cm
width	10.0 inches	25.4 cm
depth	6.0 inches	15.2 cm
Weight	Approximately 5.4 lbs (2.4 kg)	
Color, Temperature Probe		
Oral/Axillary	Blue	
Rectal	Red	

<b>Characteristic</b>	<b>Specification</b>
Support	Self-supporting on rubber feet Mountable (with available accessories) to the following: IV pole Mobile stand Wall
Portability	Recessed carry handle Mounted on a pole or mobile stand, can be rolled from patient to patient

## Electrical

### Power Requirements

The medical-rated isolation AC power adapter connected to the AC supply must supply 8 volts DC and 0.74 amperes.

### Battery

The monitor uses a (supplied) sealed lead-acid, 6V, 4 Ah battery with external recharge capability.

The battery charges to at least 90% capacity in 12 hours. The AC power adapter, when connected, simultaneously operates the monitor and charges the battery; it charges the battery more rapidly if it is not simultaneously operating the monitor.

Using a new, fully charged battery, the monitor can be operated continuously for at least 8 hours of Adult NIBP monitoring, at 3-minute intervals, with simultaneous and continuous monitoring of temperature and SpO<sub>2</sub> values.

In other words, a new, fully charged battery supports at least 165 Adult NIBP readings at 3-minute intervals while simultaneously and continuously monitoring and displaying temperature and SpO<sub>2</sub> values.

### Leakage Current

For maximum patient electrical isolation, connect a computer to the monitor only when the monitor is not connected to a patient or when the computer is outside the patient field running on battery power.

### Electrical rating descriptions

Power option	Specification
1	Input: 120VAC 60Hz , 130mA Output: 8VDC, 750mA
2	Input: 240VAC 50Hz , 65mA Output: 8VDC, 750mA Input: 230VAC 60Hz , 65mA Output: 74VDC, 750mA
4	Input: 240VAC 50Hz , 65mA Output: 8VDC, 750mA Input: 230VAC 60Hz , 65mA Output: 74VDC, 750mA
6	Input: 240VAC 50Hz , 65mA Output: 8VDC, 750mA Input: 230VAC 60Hz , 65mA Output: 74VDC, 750mA
7	Input: 220VAC 50-60Hz , 70mA Output: 8VDC, 750mA

## Environmental

### EMC Compliance

The monitor complies with all applicable and required standards for electromagnetic interference.

- It does not normally affect nearby equipment and devices.
- It is not normally affected by nearby equipment and devices.
- It is safe to operate the monitor in the presence of high-frequency surgical equipment.
- However, it is good practice to avoid using the monitor in extremely close proximity to other equipment.

---

#### **Guidance and manufacturer's declaration—electromagnetic emissions**

---

The Vital Signs Monitor 300 Series monitor is intended for use in the electromagnetic environment specified below. The customer or the user of the monitor should assure that it is used in such an environment.

<b>Emissions test</b>	<b>Compliance</b>	<b>Electromagnetic environment—guidance</b>
RF emissions CISPR 11	Group 1	The Vital Signs Monitor 300 Series monitor uses RF energy only for its internal function. Therefore, its RF emissions are very low and are not likely to cause any interference in nearby electronic equipment.
RF emissions CISPR 11	Class B	The Vital Signs Monitor 300 Series monitor is suitable for use in all establishments, including domestic establishments and those directly connected to the public low-voltage power supply network that supplies buildings used for domestic purposes.
Harmonic emissions IEC 61000-3-2	Class A	
Voltage fluctuations/flicker emissions IEC 61000-3-3	Complies	

---

---

**Guidance and manufacturer's declaration—electromagnetic immunity**

---

The Vital Signs Monitor 300 Series monitor is intended for use in the electromagnetic environment specified below. The customer or the user of the monitor should assure that it is used in such an environment.

---

<b>Immunity test</b>	<b>IEC 60601 test level</b>	<b>Compliance level</b>	<b>Electromagnetic environment— guidance</b>
Electrostatic discharge (ESD) IEC 61000-4-2	±6 kV contact ±8 kV air	±6 kV contact ±8 kV air	Floors should be wood, concrete, or ceramic tile. If floors are covered with synthetic material, the relative humidity should be at least 30%.
Electrical fast transient/burst IEC 61000-4-4	±2 kV for power supply lines ±1 kV for input/output lines	±2 kV for power supply lines ±1 kV for input/output lines	Mains power quality should be that of a typical commercial or hospital environment.
Surge IEC 61000-4-5	±1 kV differential mode ±2 kV common mode	±1 kV differential mode ±2 kV common mode	Mains power quality should be that of a typical commercial or hospital environment.
Voltage dips, short interruptions, and voltage variations on power-supply input lines IEC 61000-4-11	<5% $U_t$ (>95% dip in $U_t$ ) for 0.5 cycle 40% $U_t$ (60% dip in $U_t$ ) for 5 cycles 70% $U_t$ (30% dip in $U_t$ ) for 25 cycles <5% $U_t$ (>95% dip in $U_t$ ) for 5 sec	<5% $U_t$ (>95% dip in $U_t$ ) for 0.5 cycle 40% $U_t$ (60% dip in $U_t$ ) for 5 cycles 70% $U_t$ (30% dip in $U_t$ ) for 25 cycles <5% $U_t$ (>95% dip in $U_t$ ) for 5 sec	Mains power quality should be that of a typical commercial or hospital environment. If the user of the VSM 300 Series monitor requires continued operation during power mains interruption, it is recommended that the monitor be powered from an uninterruptible power supply or a battery.
Power frequency (50/60 Hz) magnetic field IEC 61000-4-8	3 A/m	3 A/m	Power frequency magnetic fields should be at levels characteristic of a typical location in a typical commercial or hospital environment.
Note	$U_t$ is the AC mains voltage prior to application of the test level.		

---



**Guidance and manufacturer’s declaration—electromagnetic immunity**

The VSM 300 Series monitor is intended for use in the electromagnetic environment specified below. The customer or the user of the monitor should assure that it is used in such an environment.

Immunity test	IEC 60601 test level	Compliance level	Electromagnetic environment—guidance
Conducted RF IEC 61000-4-6	3 V <sub>rms</sub> 150 kHz to 80 MHz	3 V <sub>rms</sub>	<p>Portable and mobile RF communications equipment should be used no closer to any part of the VSM 300 Series monitor, including cables, than the recommended separation distance calculated from the equation applicable to the frequency of the transmitter.</p> <p><b>Recommended separation distance</b></p> $d = 1.2 \sqrt{P}$
Radiated RF IEC 61000-4-3	3 V/m 80 MHz to 2.5 GHz	3 V/m	$d = 1.2 \sqrt{P}$ 80 MHz to 800 MHz $d = 2.3 \sqrt{P}$ 800 MHz to 2.5 GHz
<p>where <b>P</b> is the maximum output power rating of the transmitter in watts according to the transmitter manufacturer and <b>d</b> is the recommended separation distance in meters.</p> <p>Field strengths from fixed RF transmitters, as determined by an electromagnetic site survey<sup>a</sup>, should be less than the compliance level in each frequency range<sup>b</sup>.</p> <p>Interference may occur in the vicinity of equipment marked with the following symbol:</p>			
			
Note 1	At 80 MHz and 800 MHz, the higher frequency range applies.		
Note 2	These guidelines may not apply in all situations. Electromagnetic propagation is affected by absorption and reflection from structures, objects and people.		
a	Field strengths from fixed transmitters, such as base stations for radio (cellular/cordless) telephones and land mobile radios, amateur radio, AM and FM radio broadcast and TV broadcast cannot be predicted theoretically with accuracy. To assess the electromagnetic environment due to fixed RF transmitters, an electromagnetic site survey should be considered. If the measured field strength in the location in which the Vital Signs Monitor 300 Series monitor is used exceeds the applicable RF compliance level above, the Vital Signs Monitor 300 Series monitor should be observed to verify normal operation. If abnormal performance is observed, additional measures may be necessary, such as reorienting or relocating the Vital Signs Monitor 300 Series monitor.		
b	Over the frequency range 150 kHz to 80 MHz, field strengths should be less than 3 V/m.		

---

**Recommended separation distances between portable and mobile RF communications equipment and the Vital Signs Monitor 300 Series monitor**

---

The Vital Signs Monitor 300 Series monitor is intended for use in an electromagnetic environment in which radiated RF disturbances are controlled. The customer or the user of the Vital Signs Monitor 300 Series monitor can help prevent electromagnetic interference by maintaining a minimum distance between portable and mobile RF communications equipment (transmitters) and the Vital Signs Monitor 300 Series monitor as recommended below, according to the maximum output power of the communications equipment.

Rated maximum output power of transmitter <b>W</b>	Separation distance according to frequency of transmitter (meters)		
	150 kHz to 80 MHz $d = 1.2 \sqrt{P}$	80 MHz to 800 MHz $d = 1.2 \sqrt{P}$	800 MHz to 2.5 GHz $d = 2.3 \sqrt{P}$
0.01	0.12	0.12	0.23
0.1	0.38	0.38	0.73
1	1.2	1.2	2.3
10	3.8	3.8	7.3
100	12	12	23

For transmitters rated at a maximum output power not listed above, the recommended separation distance  $d$  in meters (m) can be estimated using the equation applicable to the frequency of the transmitter, where  $P$  is the maximum output power rating of the transmitter in watts (w) according to the transmitter manufacturer.

NOTE 1 At 80 MHz and 800 MHz, the separation distance for the higher frequency range applies.

NOTE 2 These guidelines may not apply in all situations. Electromagnetic propagation is affected by absorption and reflection from structures, objects and people.

---

## Other Environmental Specifications

Characteristic	Specification
Operating Temperature	
SpO <sub>2</sub> , NIBP, pulse rate, and temperature measurement	+10 °C to +40 °C +50 °F to +104 °F
Operating altitude	-170 m to +4877 m -557 ft to + 16,000 ft
Shipping altitude	-615 m to 12,300 m -2000 ft to 40,000 ft
Storage temperature	-20 °C to +50 °C -4 °F to +122 °F
Relative humidity	15% to 90% (non-condensing)

---

## Nurse Call

---

**Switch current** 1A maximum

**Switch voltage** 30V ac/dc maximum

**Isolation** 1500 Vrms

**Alarm relay** Energized during patient alarm

**Cable** Welch Allyn part number 008-0634-XX, customized to connect to the local Nurse Call system.

Cable properties:

- 10 feet (3 meters) long.
- Not shielded.
- One end not terminated (to be customized on site).
- One end terminated with a connector which mates to the Nurse Call connector (shown below) on the monitor.

4 (not connected)

1 (Black)  
Normally Open

2 (Red) Arm

3 (Green)  
Normally Closed

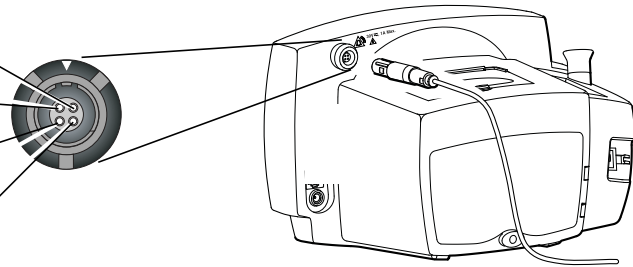

## Factory Default Settings

<b>Function</b>	<b>Value</b>
Blood pressure measurement units	mmHg
Patient type	Adult
Automatic NIBP Interval	15 minutes
MAP (Adult and Pediatric)	Disabled
MAP (Neonate)	Enabled
NIBP Adult High Systolic Alarm	220 mmHg
NIBP Adult Low Systolic Alarm	75 mmHg
NIBP Adult High Diastolic Alarm	110 mmHg
NIBP Adult Low Diastolic Alarm	35 mmHg
NIBP Adult High MAP Alarm	120 mmHg
NIBP Adult Low MAP Alarm	50 mmHg
NIBP Pediatric High Systolic Alarm	145 mmHg
NIBP Pediatric Low Systolic Alarm	75 mmHg
NIBP Pediatric High Diastolic Alarm	100 mmHg
NIBP Pediatric Low Diastolic Alarm	35 mmHg
NIBP Pediatric High MAP Alarm	110 mmHg
NIBP Pediatric Low MAP Alarm	50 mmHg
NIBP Neonatal High Systolic Alarm	120 mmHg
NIBP Neonatal Low Systolic Alarm	50 mmHg
NIBP Neonatal High Diastolic Alarm	70 mmHg
NIBP Neonatal Low Diastolic Alarm	30 mmHg
NIBP Neonatal High MAP Alarm	80 mmHg
NIBP Neonatal Low MAP Alarm	35 mmHg
SpO <sub>2</sub> Adult High Alarm	---
SpO <sub>2</sub> Adult Low Alarm	85%
SpO <sub>2</sub> Pediatric High Alarm	---
SpO <sub>2</sub> Pediatric Low Alarm	85%
SpO <sub>2</sub> Neonatal High Alarm	95%
SpO <sub>2</sub> Neonatal Low Alarm	85%
Temperature Scale	°F (Fahrenheit predictive)
Pulse Rate Adult High Alarm	120 beats per minute
Pulse Rate Adult Low Alarm	50 beats per minute
Pulse Rate Pediatric High Alarm	150 beats per minute
Pulse Rate Pediatric Low Alarm	50 beats per minute
Pulse Rate Neonatal High Alarm	200 beats per minute
Pulse Rate Neonatal Low Alarm	100 beats per minute
Pulse Tone Volume	03
Print Control	Batch
Time-of-day Display	24-hour

# Limited Warranty

---

This product is sold by Welch Allyn under the warranties set forth in the following paragraphs. These warranties are extended only to the end-user with respect to the original purchase of this product directly from Welch Allyn or from Welch Allyn's authorized distributors.

For two years from the date of the original delivery to the buyer (one year for remanufactured monitors), the Vital Signs Monitor 300 Series is warranted to be free from functional defects in materials and workmanship and to conform in all material respects to the description of the product contained in the directions for use and other labeling of the product.

This warranty is valid only under the following conditions:

- The product is properly operated under conditions of normal use in accordance with applicable safety and regulatory requirements;
- The product is configured, modified, adjusted and repaired only by Welch Allyn or by persons expressly authorized by Welch Allyn, in accordance with Welch Allyn's service procedures; and
- The product has not been damaged by misuse, negligence, or accident.

For a period of 90 days, unless otherwise specified, this same warranty is made for any accessories provided by Welch Allyn.

Under the above warranties, Welch Allyn's sole and exclusive obligation and buyer's sole and exclusive remedy is limited to the repair or replacement, at the discretion of Welch Allyn, free of charge, of products found to be defective during the warranty period. Warranty claims must be made, not more than seven days after expiration of the warranty period, by calling the customer service number shown below to obtain a returned material authorization number (RMA), and returning the product with the RMA documentation, transportation charges prepaid, to the address specified by Welch Allyn customer service.

Welch Allyn  
8500 S.W. Creekside Place  
Beaverton, Oregon 97008-7107 USA  
Telephone: (503) 530-7500 or (800) 289-2500  
Facsimile: (503) 526-4200

Welch Allyn shall not be otherwise liable for any damages, including but not limited to incidental, consequential, or special damages.

No express or implied warranties extend beyond the warranties defined in this document. Welch Allyn makes no warranty of merchantability or fitness for a particular purpose.



# Index

---

## A

- AC power
  - connecting, 9
- adult
  - see also* patient type
  - defined, 22
  - icon, 3
- alarm
  - high and low, 55
  - MAP, 34, 56
  - patient, 51
  - range limits, 56
  - responding to, 51
  - setting, 54
  - tone, 51
- alarm limits
  - range, 72
- alert
  - responding to, 52
- autoclave, 5
- axillary temperature, 45

## B

- batch printing, 27, 60
- battery
  - charge before using, 10
  - charging, 9
  - failure, 69
  - low charge warning, 69
  - low power indicator, 10
- blood pressure
  - automatic, 33
  - manual, 32
  - monitoring, 29
- buttons
  - description, 8

## C

- CAL message, 32
- cautions
  - NIBP, 29

- SpO<sub>2</sub>, 37
  - temperature, 40
- CE certification, 2
- Celsius
  - units, selecting, 25
- charging the battery, 9
- classification, 71
- cleaning, 67
- configuration, 16
- connections
  - location, 8
- controls
  - description, 8
- CSA certification, 2
- cuff
  - positioning, 31
  - pressure, preset, 30
  - selecting, 31

## D

- data
  - erasing, 65
- default values, 80
- displays
  - description, 6

## E

- equipment alert, 52
- erasing patient data, 65
- error codes, 58

## F

- factory defaults, 80
- Fahrenheit
  - units, selecting, 25
- FDA, 71

## I

- indicators

- description, 7
- intended use, 1
- intravenous infusion
  - warning, 29

## K

- kPa
  - units, selecting, 24

## M

- maintenance, 67
- MAP
  - alarm, 34, 56
- measurement
  - data, reviewing, 59
  - units, setting, 24
- mmHg
  - units, selecting, 24
- monitor
  - configuration, 16
  - setup, 16
- monitored temperature, 41, 48
- monitoring
  - blood pressure, 29
  - pulse rate, 36
  - SpO<sub>2</sub>, 37
  - temperature, 40

## N

- neonatal
  - see also* patient type
  - defined, 22
  - icon, 3
- NIBP, 29
  - automatic, 33
  - cycle, ending, 35
  - manual, 32
  - preparation, 30
  - STAT, 36
- nurse call
  - connector location, 57

## O

- operating parameters
  - setting, 16
- oral temperature, 43

## P

- paper, replacing, 66

- patient alarm, 51
- patient data, reviewing, 59
- patient type
  - and alarm limits, 56
  - and cuff size, 31
  - and MAP enable/disable, 23, 36
  - changing, 22
  - selecting, 17
  - setting, 22
  - status indicator, 7
- pediatric
  - see also* patient type
  - defined, 22
  - icon, 3
- power, 9
- power-on self-test, 15
- predictive temperature, 41
- printer
  - output, 61
  - replacing paper, 66
- printing patient data, 27
- programmed limits, 51

## R

- READING message, 59
- rectal temperature, 47
- review, 59

## S

- safety
  - warnings and cautions, 4
- setup, 9
- software
  - license agreement, ii
- specifications
  - temperature, 72
- SpO<sub>2</sub>
  - cable connection, 13
  - measuring, 37
- STAT interval, 36
- storage, 67
- stored data, 59
- stream printing, 27, 60

## T

- temperature
  - monitoring, 40
  - operating, monitor, 78
  - parameters, setting, 41
  - probe cable connection, 12
- trademarks, ii



## V

### vital signs

- alarms, 51
- blood pressure, 29
- pulse rate, 36
- SpO<sub>2</sub>, 37
- temperature, 40

## W

### warnings

- general, 4
- NIBP, 29
- SpO<sub>2</sub>, 37
- temperature, 40

