

Welch Allyn Connex[®] Vital Signs Monitor 6000 Series[™]



Directions for use

Software versions 1.0X–1.7X

WelchAllyn[®]

Advancing Frontline Care[™]

© 2011 Welch Allyn. All rights are reserved. To support the intended use of the product described in this publication, the purchaser of the product is permitted to copy this publication, for internal distribution only, from the media provided by Welch Allyn. No other use, reproduction, or distribution of this publication, or any part of it, is permitted without written permission from Welch Allyn. Welch Allyn assumes no responsibility for any injury to anyone, or for any illegal or improper use of the product, that may result from failure to use this product in accordance with the instructions, cautions, warnings, or statement of intended use published in this manual.

Welch Allyn, Connex, SureTemp, FlexiPort, and SureBP are registered trademarks of Welch Allyn.

Vital Signs Monitor 6000 Series is a trademark of Welch Allyn.

LNCS, SpHb, ReSposable, and Rainbow are trademarks of, and SET, LNOP, and Masimo are registered trademarks of, Masimo Corporation. Possession or purchase of a Masimo SpO2- or Masimo SpHb-equipped device does not convey any express or implied license to use the device with unauthorized sensors or cables which would, alone or in combination with this device, fall within the scope of one or more of the patents relating to this device.

Nellcor and OxiMax are registered trademarks of Nellcor Puritan Bennett Inc.

Braun and ThermoScan are registered trademarks of Braun GmbH.

Health o meter is a registered trademark of Sunbeam Products, Inc., used under license.

Software in this product is Copyright 2011 Welch Allyn or its vendors. All rights are reserved. The software is protected by United States of America copyright laws and international treaty provisions applicable worldwide. Under such laws, the licensee is entitled to use the copy of the software incorporated with this instrument as intended in the operation of the product in which it is embedded. The software may not be copied, decompiled, reverse-engineered, disassembled, or otherwise reduced to human-perceivable form. This is not a sale of the software or any copy of the software; all right, title, and ownership of the software remain with Welch Allyn or its vendors.

For information about any Welch Allyn product, call Welch Allyn Technical Support:

USA +1 800 535 6663
+1 315 685 4560
Canada +1 800 561 8797
European Call Center +353 46 90 67790
Germany +49 695 098 5132
Japan +81 42 703 6084
Malaysia +603 7875 3341
Singapore +65 6419 8100
Spain +34 917 499 357
United Kingdom +44 207 365 6780

Australia +61 2 9638 3000
China +86 21 6327 9631
France +33 155 69 58 49
Italy +39 026 968 2425
Latin America +1 305 669 9003
Netherlands +31 202 061 360
South Africa +27 11 777 7555
Sweden +46 85 853 6551

REF 103730 (CD)
Material Number 408102, Ver. B

REF 103501 (printed copy)
Material Number 717085, 80016590 Ver. B

Software versions 1.0X–1.7X



Welch Allyn, Inc.
4341 State Street Road
Skaneateles Falls, NY 13153-0220 USA
www.welchallyn.com

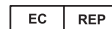

Regulatory Affairs Representative
Welch Allyn Limited
Navan Business Park
Dublin Road
Navan, County Meath
Republic of Ireland



Advancing Frontline Care™

Contents

Introduction	1
Intended use	1
Contraindications	1
Symbols	3
Screen elements	5
About warnings and cautions	9
General warnings and cautions	9
Controls, indicators, and connectors	13
Setup	17
Supplies and accessories	17
Insert the battery	17
Mount the monitor on a stand	18
Mount the monitor on the wall	18
Attach the probe well	18
Attach the temperature probe	19
Remove the temperature probe and well	20
Connect the NIBP hose	20
Disconnect the NIBP hose	21
Connect the SpO ₂ cable	21
Disconnect the SpO ₂ cable	21
Attach an accessory	22
Detach an accessory	22
Insert a new roll of paper	22
Connect AC power	23
Disconnect AC power	24
Startup	25
Power	25
Power up the monitor	26
Power down the monitor	27
Reset the monitor	27
Set the date and time	27
Enter clinician information	28
Set the default configuration	28

Navigation	29
Home tab	29
Device Status area	29
Content area	31
Navigation area	32
Profiles	35
Select a profile	37
Using the keypad, keyboard, and barcode scanner	39
Open the numeric keypad	39
Numeric keypad	39
Enter a number	40
Close the numeric keypad	40
Open the keyboard	40
Keyboard	40
Enter a letter or number	42
Enter a symbol or special character	42
Enter a diacritical mark	42
Close the keyboard	43
Use a barcode scanner	43
Patient data management	45
Add a patient to the patient list	45
Load patient data with the barcode scanner	45
Select a patient	46
Manage patient records	46
Print patient data	47
Printer	48
Delete a patient from the list	48
Modifiers	49
Set modifiers	49
Alarms	51
Reset (pause or turn off) audio alarms	54
Adjust vital sign alarm limits	55
Modify audio alarm notification	55
Alarm messages and priorities	56
Nurse call	59
Patient monitoring	61
NIBP	61
Temperature	70
SpO2	80
SpHb	85
Pulse rate frame	88
Manual parameters frame	89
Maintenance and service	93
Perform periodic checks	93
Replace the printer paper	93
Change the battery	95

Clean the monitor	96
Clean the accessories	97
Clean the stand	97
Specifications	99
Physical specifications	99
Environmental specifications	103
Monitor radio	104
Configuration options	105
Patents	105
Standards and compliance	107
General compliance and standards	107
General radio compliance	108
Guidance and manufacturer's declaration	111
EMC compliance	111
Emissions and immunity information	111
Advanced settings	115
General	115
Parameters	119
Data management	123
Network	126
Service	128
Troubleshooting	129
NIBP messages	129
SpO2 and SpHb messages	130
Temperature messages	131
Weight scale messages	132
Patient data management messages	132
Radio messages	133
Ethernet messages	133
USB messages	133
System messages	134
Battery power manager messages	134
Configuration Manager messages	135
Printer messages	135
Problems and solutions	136
Appendix	137
Approved accessories	137
Warranty	145

Introduction

This manual describes the capabilities and operation of the monitor. The information, including the illustrations, pertains to a monitor configured with noninvasive blood pressure (NIBP), body temperature, pulse oximetry (SpO₂), total hemoglobin concentration (SpHb), pulse rate, and weight scale options. If your monitor configuration lacks any of these options, some information in this manual might not apply.

Before using the monitor, read the sections of the manual that pertain to your use of the monitor.

Intended use

The VSM 6000 Series of monitors is intended to be used by clinicians and medically qualified personnel for monitoring of neonatal, pediatric, and adult patients for:

- noninvasive blood pressure,
- pulse rate,
- noninvasive functional oxygen saturation of arteriolar hemoglobin (SpO₂), and
- body temperature in normal and axillary modes.

The most likely locations for patients to be monitored are general medical and surgical floors, general hospital, and alternate care environments.

The optional Masimo Rainbow SET® and accessories are indicated for the continuous noninvasive monitoring of total hemoglobin concentration of adult, pediatric, and neonatal patients during both motion and no motion conditions, and for patients who are well or poorly perfused in hospitals and hospital-type facilities.

Optional compatible weight scales (e.g., Health o meter®) can be used for height, weight, and BMI input.

This product is available for sale only upon the order of a physician or licensed health care professional.

Contraindications

This system is not intended to be used:

- on patients connected to heart/lung machines
- on patients being transported outside a healthcare facility
- near an MRI machine
- in a hyperbaric chamber
- near flammable anesthetics

- near electro-cauterization devices

For contraindications of SpO₂ and SpHb sensors, consult the sensor manufacturer's directions for use.

Symbols

Documentation symbols



WARNING The warning statements in this manual identify conditions or practices that could lead to illness, injury, or death.



Caution The caution statements in this manual identify conditions or practices that could result in damage to the equipment or other property, or loss of data. This definition applies to both yellow and black and white symbols.



WARNING Hot surface. Do not touch.



Consult operating instructions.

Power symbols



Power on/standby



Equipotential terminal



(on the display) monitor is plugged into Alternating Current power



Battery absent or faulty



(on the monitor, green indicator) Alternating Current power present, battery fully charged







Battery charge level







(on the monitor, amber indicator) Alternating Current power present, battery is charging











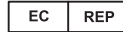

Battery cover

	Alternating Current (AC)		Rechargeable battery
	Li-ion battery		AC input power

Connectivity symbols

	USB		Ethernet RJ-45
	<p>Wireless signal strength</p> <ul style="list-style-type: none"> • Best (4 bars) • Good (3 bars) • Fair (2 bars) • Weak (1 bar) • No signal (no bars) • No connection (blank) 		Nurse call

Miscellaneous symbols

	Meets essential requirements of European Medical Device Directive 93/42/EEC		European Community Representative
	Manufacturer		Defibrillation-proof Type BF applied parts
	Reorder number		Serial number
	Do not reuse		China RoHS markings for control of pollution caused by electronic information products. XX indicates Environmentally Friendly Use Period in years.
	Nonionizing electromagnetic radiation		Recycle the product separate from other disposables
	Restrictions for use of wireless device in Europe. European Community's Class 2 radio equipment.		Call for maintenance

Screen elements

Global navigation



Select option



NIBP



NIBP start



NIBP stop



Intervals status indicators



NIBP view toggle



Temperature



Temperature site control



Process indicator



Direct mode selector

SpO2 and Pulse rate



Pulse amplitude bar



SatSeconds timer (Nellcor feature only)

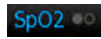

SpO2 view toggle



Response mode selector (touch for Fast mode)



Heart rate (in beats per minute)

Total hemoglobin (SpHb)



SpHb view toggle



Averaging selector

Manual parameters

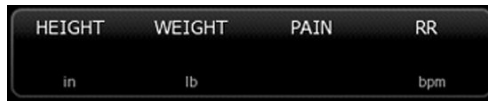

Manual parameter selector

Alarm and information messages



Alarm limit button



Alarm On/Off toggle



Multiple alarms toggle

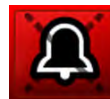







Alarm audio paused



Alarm active

Patients list and review

- List
- Summary
- Modifiers
- Manual



	Diacritical marks key (available for languages that use diacritical marks; appearance differs based on language)		Symbols key
	Send patient test reports		Print patient test reports
	Cancel print request		Add patient identifiers
	Retrieve the patient list from the network		

Settings

	Save configuration settings
---	-----------------------------

Advanced settings

- General
- Parameters
- Data Management
- Network
- Service

	Save to USB flash drive		Configure from USB flash drive
	Restore factory default settings		

About warnings and cautions

Warning and caution statements can appear on the monitor, on the packaging, on the shipping container, or in this document.

The monitor is safe for patients and clinicians when used in accordance with the instructions and with the warning and caution statements presented in this manual.

Before using the monitor, familiarize yourself with the sections of this directions for use that pertain to your use of the monitor.

- Failure to understand and observe any warning statement in this manual could lead to patient injury, illness, or death.
- Failure to understand and observe any caution statement in this manual could lead to damage to the equipment or other property, or loss of patient data.

General warnings and cautions



WARNING Many environmental variables, including patient physiology and clinical application, can affect the accuracy and performance of the monitor. The clinician must verify all vital signs information before treating the patient. If there is any question about the accuracy of a measurement, verify the measurement using another clinically accepted method.



WARNING Alarm limits are patient- or facility-specific. The clinician must set or verify alarm limits appropriate for each patient. Each time the monitor is powered on, you must check that the alarm settings are appropriate for your patient before you start monitoring.



WARNING The monitor is not intended for use during patient transport outside of the medical facility. Do not use the monitor to take measurements on any patient in transit.



WARNING Use only Welch Allyn approved accessories, and use them according to the manufacturer's directions for use. Using unapproved accessories with the monitor can affect patient and operator safety and can compromise product performance and accuracy.



WARNING Inaccurate measurement risk. Do not connect more than one patient to a monitor.



WARNING Inaccurate measurement risk. Dust and particle ingress can affect the accuracy of blood pressure measurements. Use the monitor in clean environments to ensure measurement accuracy. If you notice dust or lint build-up on the monitor's vent openings, have the monitor inspected and cleaned by a qualified service technician.



WARNING Liquids can damage electronics inside the monitor. Prevent liquids from spilling on the monitor.

If liquids are spilled on the monitor:

1. Power down the monitor.
2. Disconnect the power plug.
3. Remove battery pack from the monitor.
4. Dry off excess liquid from the monitor.

Note If liquids possibly entered the monitor, remove the monitor from use until it has been properly dried, inspected, and tested by qualified service personnel.

5. Reinstall battery pack.
6. Power on the monitor and verify that the monitor functions normally before using it.

If liquids enter the printer housing:

1. Power down the monitor.
2. Disconnect the power plug.
3. Remove battery pack from the monitor.
4. Remove and discard the paper roll.
5. Clean and dry the inside of the printer housing.

Note The printer housing has a drain tube that directs liquids down and out the bottom of the monitor. If liquids possibly entered other openings in the monitor, remove the monitor from use until it has been properly dried, inspected, and tested by qualified service personnel.

6. Install a new roll of paper.
7. Power on the monitor and verify that the monitor functions normally before using it.



WARNING Safety risk. Damaged cords, cables, and accessories can affect patient and operator safety. Never lift the monitor by the power supply cord or patient connections. Routinely inspect the AC power cord, blood pressure cuff, SpO₂ cable, and other accessories for strain relief wear, fraying, or other damage. Replace as necessary.



WARNING Fire and explosion hazard. Do not operate the monitor in the presence of a flammable anesthetic mixture with air, oxygen, or nitrous oxide; in oxygen-enriched environments; or in any other potentially explosive environment.



WARNING Fire and shock hazard. Only connect LAN cables contained within the perimeter of a single building. Conductive LAN cables spanning multiple buildings may introduce fire or shock hazards unless they are fitted with fiber optic cables, lightning arrestors, or other applicable safety features.



WARNING The monitor may not function properly if dropped or damaged. Protect it from severe impact and shock. Do not use the monitor if you notice any signs of damage. Qualified service personnel must check any monitor that is dropped or damaged for proper operation before putting the monitor back into use.



WARNING Defective batteries can damage the monitor. If the battery shows any signs of damage or cracking, it must be replaced immediately and only with a battery approved by Welch Allyn.



WARNING Improper disposal of batteries may create an explosion or contamination hazard. Never dispose of batteries in refuse containers. Always recycle batteries according to local regulations.



WARNING Electric shock hazard. Do not open the monitor or attempt repairs. The monitor has no user-serviceable internal parts. Only perform routine cleaning and maintenance procedures specifically described in this manual. Inspection and servicing of internal parts shall only be performed by qualified service personnel.



WARNING Inaccurate measurement risk. Do not expose to temperatures higher than 122° F (50° C).



WARNING Inaccurate measurement risk. Do not use the monitor on patients who are on heart-lung machines.



WARNING Use the monitor only as described in this directions for use. Do not use the monitor on patients as described in the Contraindications.



WARNING Inaccurate measurement risk. Do not use the monitor on patients who are experiencing convulsions or tremors.



WARNING Wall mounted equipment and accessories must be installed in accordance with accompanying instructions. Welch Allyn is not responsible for the integrity of any installation not performed by authorized Welch Allyn service personnel. Contact an authorized Welch Allyn service representative or other qualified service personnel to ensure professional installation for safety and reliability of any mounting accessory.



WARNING Do not place the monitor in any position that might cause it to fall on the patient.



WARNING Welch Allyn is not responsible for the integrity of a facility's power. If the integrity of a facility's power or protective earth conductor is in doubt, always operate the monitor on battery power alone when it is attached to a patient.



WARNING Equipment damage and personal injury risk. When transporting the monitor on a mobile stand, properly secure all patient cables and cords to keep them clear of the wheels and to minimize trip hazards.



WARNING For operator and patient safety, peripheral equipment and accessories that can come in direct patient contact must comply with all applicable safety, EMC, and regulatory requirements.



WARNING All signal input and output (I/O) connectors are intended for connection of only devices complying with IEC 60601-1, or other IEC standards (for example, IEC 60950), as applicable to the monitor. Connecting additional devices to the monitor may increase chassis or patient leakage currents. To maintain operator and patient safety, consider the requirements of IEC 60601-1-1. Measure the leakage currents to confirm that no electric shock hazard exists.



WARNING Equipment failure and patient harm risk. Do not cover the air intake or exhaust vents on the rear and base of the monitor. Covering these vents could cause overheating of the monitor or muffling of alarms.



WARNING This equipment is not suitable for use in the presence of electro-surgery.



WARNING Cross-contamination or nosocomial infection risk. Clean and disinfect the monitor on a routine basis according to your facility's protocols and standards or local regulations. Thorough hand-washing before and after contact with patients greatly reduces the risk of cross-contamination and nosocomial infection.



Caution United States Federal law restricts this monitor to sale, distribution, or use by or on the order of a physician or licensed healthcare professional.



Caution Electromagnetic interference risk. The monitor complies with applicable domestic and international standards for electromagnetic interference. These standards are intended to minimize medical equipment electromagnetic interference. Although this monitor is not expected to present problems to other compliant equipment or be affected by other compliant devices, interference issues still may occur. As a precaution, avoid using the monitor in close proximity to other equipment. In the event that equipment interference is observed, relocate the equipment as necessary or consult manufacturer's directions for use.



Caution Use only a Class I (grounded) AC power supply cord for powering this monitor.



Caution Do not use a long press of  to power down the monitor when it is functioning normally. You will lose patient data and configuration settings.



Caution Never move the monitor or mobile stand by pulling on any of the cords as this may cause the monitor to tip over or may damage the cord. Never pull on the power cord when removing it from the power outlet. When disconnecting the power cord, always grasp the attachment plug and not the cord. Keep the cord away from liquids, heat, and sharp edges. Replace the power cord if the strain relief or cord insulation is damaged or begins to separate from the attachment plug.



Caution Use only the Welch Allyn USB client cable to connect a laptop computer to the USB client port. Any laptop connected to the monitor must be running on a battery, a 60601-1 compliant power supply, or a 60601-1 compliant isolation transformer.



Caution If the touchscreen is not responding properly, refer to the troubleshooting section. If the problem cannot be resolved, discontinue use of the monitor and contact an authorized Welch Allyn service center or qualified service personnel.



Caution Verify patient identity on the monitor after manual or barcode entry and before printing or transferring patient records.

Controls, indicators, and connectors

Note Your model might not contain all of these features.

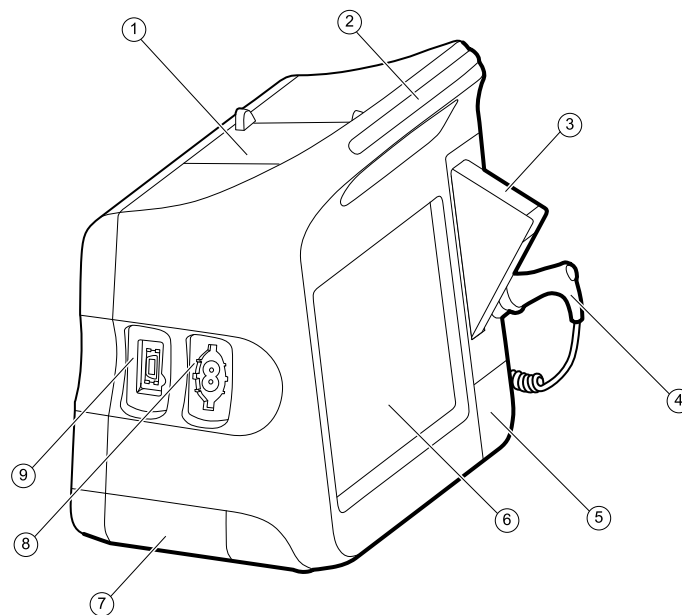

No.	Feature	Description
1	Printer	Optional. Printer provides a printout of patient and device information.
2	Light bar	Provides a visual alarm with red and amber LEDs.
3	Thermometry	Optional. Temperature probe cover box.
4	Thermometry	Optional. Temperature probe.
5	Thermometry (connector behind cover)	Secures the probe connection to the monitor.
6	LCD screen	1024 x 600 pixels color touchscreen provides a graphical user interface.
7	Battery compartment (behind cover)	Houses the Li-ion battery.

No.	Feature	Description
8	Blood pressure	Self-contained module for easy replacement. Supports dual-lumen or single-lumen hoses.
9	Pulse oximetry	Optional Nellcor (SpO2) or Masimo Rainbow SET (SpO2 or combined SpO2/SpHb) in a self-contained module for easy replacement.

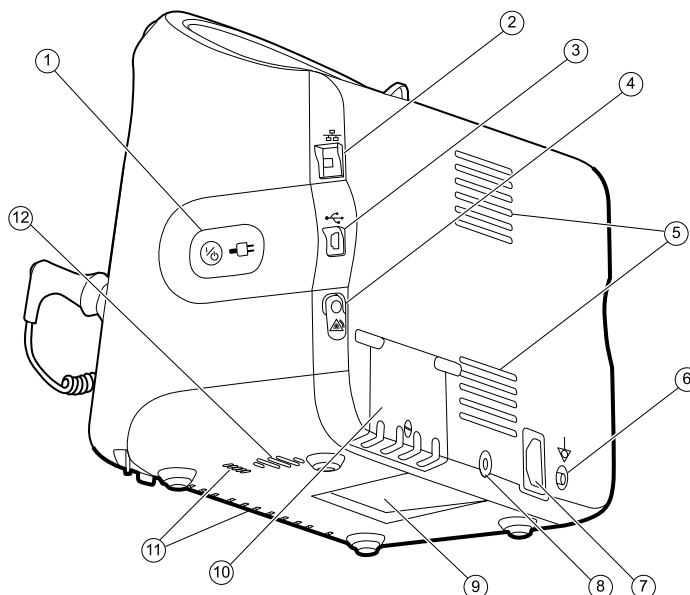

No.	Feature	Description
1	Power switch and LED	Power-on/Standby switch. The LED indicates the charging status when connected to AC power: <ul style="list-style-type: none"> • Green: The battery is charged. • Amber: The battery is charging.
2	Ethernet RJ-45	Provides a hardwired connection to the computer network.
3	USB client	Provides a connection to an external computer for testing and software upgrades.
4	Nurse call	Optional. Provides a connection to the hospital nurse call system. (Not available on the 6300 model.)
5	Fan exhaust	
6	Ground lug (equipotential terminal)	Provided for electrical safety testing and as a means for connection of a potential equalization conductor.
7	Power connection	Provides an external AC power connection.
8	Mobile stand mounting hardware	Secures the mounting plate to the monitor.

No.	Feature	Description
9	Recess for mounting plate	Secures the monitor when mounted on the mobile stand or wall.
10	USB connector door	Provides access to host USB connections for optional accessories.
11	Fan intake	
12	Speaker	Provides tones. A piezo beeper inside the monitor provides backup.

Setup

Supplies and accessories

For a list of all approved supplies and accessories, see *Approved Accessories* in the Appendix.

Insert the battery

This procedure applies to first-time setup of the monitor. Therefore, the monitor is assumed to be shut down.



WARNING Risk of fire, explosion, and burns. Do not short-circuit, crush, incinerate, or disassemble the battery pack.

1. Turn the monitor upside down to access the battery cover.
2. Locate the battery cover, indicated by .
3. Insert a coin into the slot and push to open. Choose a coin that fits comfortably into the slot.

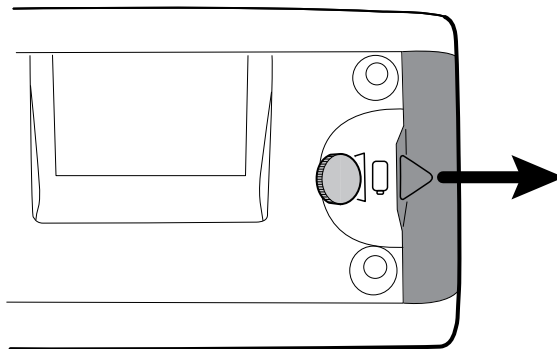

4. Slide in the battery.

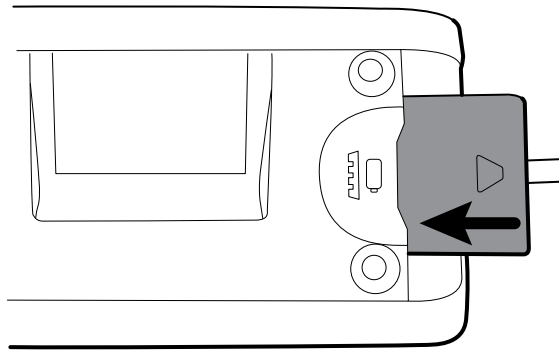

Note Do not remove the tab label from the battery. This tab helps you remove the battery from the compartment when you need to replace it.

5. Replace the battery cover by inserting one end into the notched access and then pressing firmly on the opposite end.

Note New batteries are only 30 percent charged. Therefore, connect the battery to AC power immediately after inserting a new a battery.

Mount the monitor on a stand

1. Align the monitor on the black plate in the center of the stand tray.
2. Tighten the screw on the plate into the screw hole on the back of the monitor.

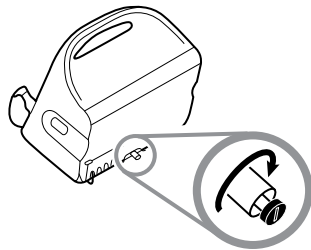

Mount the monitor on the wall

For mounting instructions, see the wall mount manufacturer's directions for use.

Attach the probe well

1. Align the probe well with the tabs facing up and down and insert the probe well into the temperature module.

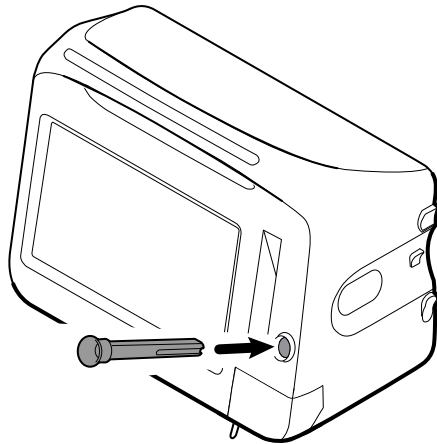

The probe well snaps into place when it is fully seated.

2. Insert the temperature probe into the probe well.

Attach the temperature probe



Caution The temperature module only operates with the probe well properly in place.

1. Remove the cover of the temperature module by pressing the tab and sliding the cover to the right. The cover is located at the bottom-right of the monitor, below the probe well.

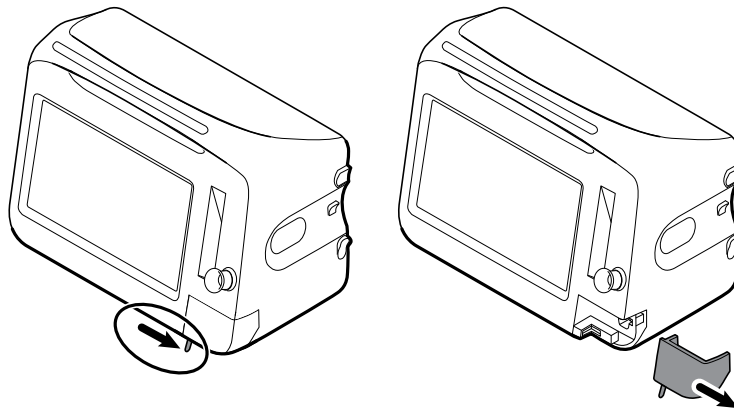

2. Hold the temperature probe cable connector with the spring tab on the right and insert it into the probe port of the temperature module.

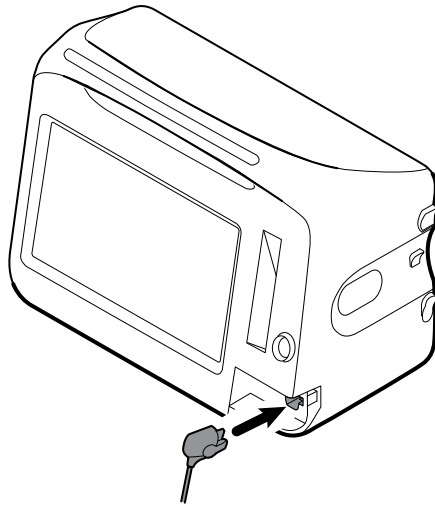

3. Push it into place until it clicks.
4. Reattach the cover. Use the alignment tab and slide the cover to the left to click it back into place.

Remove the temperature probe and well

Follow these steps to disconnect the probe cable and remove the probe well.

1. Remove the cover of the temperature module by pressing the tab and sliding the cover to the right. The cover is located at the bottom-right of the monitor, below the probe well.
2. Depress the spring tab on the temperature probe cable connector and withdraw it from the probe port.
3. Reattach the cover. Use the alignment tab and slide the cover to the left to click it back into place.

Grasp the probe well and pull it up to remove it from the monitor.

Connect the NIBP hose

1. Place your thumb and forefinger on the hose connector and squeeze the side tabs.
2. Align the hose connector with the hose connector port on the side of the monitor.

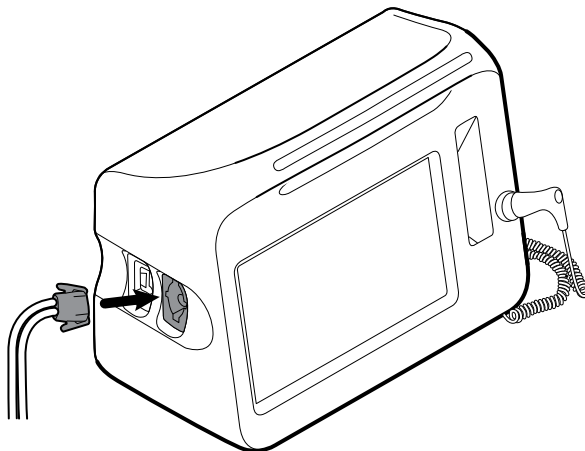

3. Insert the hose connector, pressing firmly until it clicks into place.

Disconnect the NIBP hose

1. Place your thumb and forefinger on the hose connector.

Note Always grasp the hose by the connector. Do not pull on the hose itself.

2. Squeeze the side tabs until the connector releases.
3. Pull the connector away from the connector port.

Connect the SpO2 cable



WARNING Patient injury risk. Do not use a damaged sensor or pulse oximetry cable or a sensor with exposed electrical or optical components.

1. Place your thumb and forefinger on the SpO2 cable connector and squeeze the side tabs.

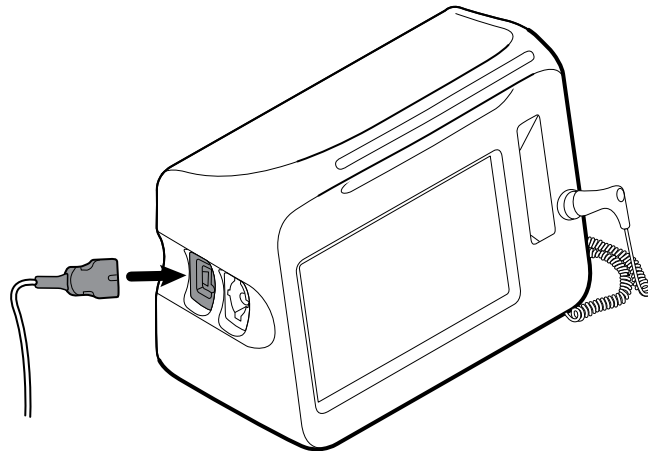

2. Align the cable connector with cable connector port.
3. Insert the cable connector, pressing firmly until it clicks into place.

Note For monitors configured with SpHb, the cable used to monitor SpHb uses the same port and also measures SpO2.

Disconnect the SpO2 cable

1. Place your thumb and forefinger on the cable connector.

Note Always grasp the cable by the connector. Do not pull on the cable itself.

2. Squeeze the side tabs until the connector releases.
3. Pull the connector away from the connector port.

Attach an accessory



Caution Accessories attached to this monitor must run on battery power. Do not use any accessory's external power supply when it is attached to the monitor.

1. On the rear of the monitor, loosen the screw on the USB door and open it.
2. Attach the accessory's USB cable into an unused USB port on the monitor. The example below shows how to attach cables for a barcode scanner and a mobile stand light.

For information about attaching any other accessory, refer to the instructions provided with the accessory.



Caution Connect cables in a manner that minimizes entangling.

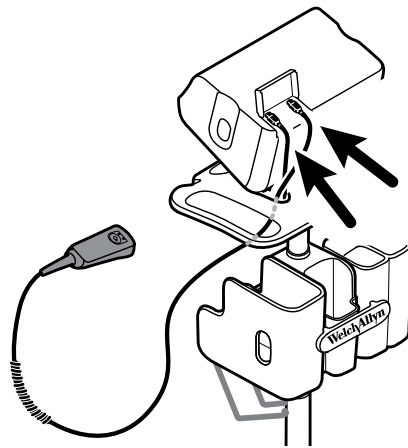

3. Close the door and tighten the screw.

Note Some accessories require a license to enable them for use. These accessories are packaged with an authorization code and instructions for activating the license using the Welch Allyn Service Tool. For more information, refer to the instructions and the service tool installation guide.

Detach an accessory

1. On the rear of the monitor, loosen the screw on the USB door and open it.
2. Detach the accessory's USB cable from USB port on the monitor.
3. Close the door and tighten the screw.

Insert a new roll of paper

The printer is located on the top of the monitor. Follow these steps to insert the roll of printer paper:

1. Grasp the two tabs and pull up to open the printer door.
2. Insert a new roll of paper.

Note The paper roll must be installed as illustrated. If the paper roll is not installed correctly, the printer will not print properly.

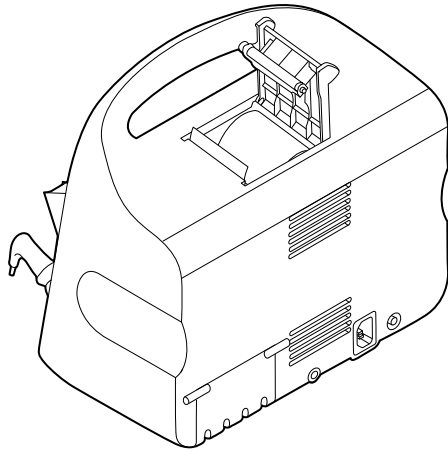

3. Advance the end of the roll past the roller so that it extends past the printer door, as shown.

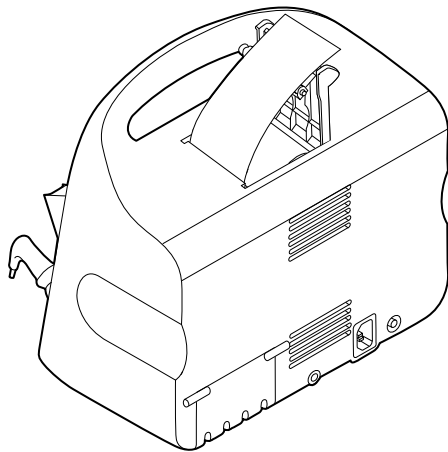

4. With one hand, pull lightly on the paper to take up any slack. With the other hand, close the printer door by pushing it down and into place until it clicks.

Be certain that the paper does not catch in the printer door.

Connect AC power

You can use the monitor with AC or battery power (after charging the battery).

1. Insert the power cord into the AC power connector port on the back of the monitor.

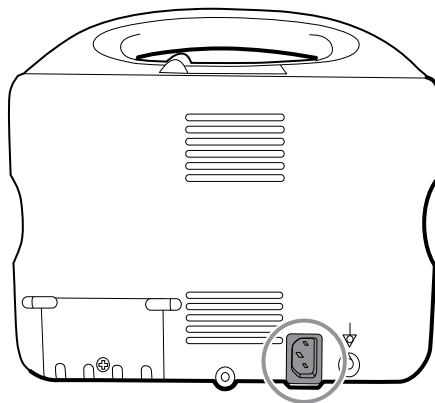

2. Insert the power plug into a power outlet to power the monitor and to charge the battery.

Disconnect AC power

Disconnect the power plug from the power outlet.

Startup

Power

The power button, located on the side of the monitor, performs the following functions:

- Powers up the monitor
- Sets the monitor into Display power saving mode, except when an alarm condition is active (brief press)
- Resets the monitor and sets the monitor into Standby mode (press and hold for 6 seconds)



Caution Do not use a long press of  to power down the monitor when it is functioning normally. You will lose patient data and configuration settings.

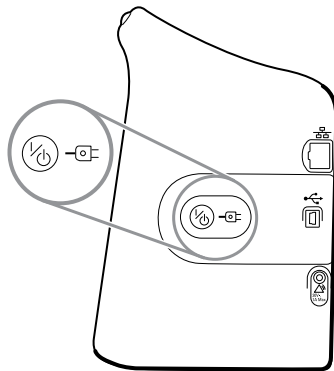

The LED in the center of the power plug symbol indicates the battery charging status:

- Green indicates that AC power is present and that the battery is fully charged.
- Amber indicates that AC power is present and that the battery is charging.

The monitor has distinct power states.

Monitor on

The monitor is operating on battery power or AC power. You can utilize the monitor's features, and the display is active.

Display power saving

The monitor is operating on battery or AC power, but the display is off to conserve power. A brief press of the power button sets the monitor into Display power saving mode from the active state. Settings for this mode can be changed in the Advanced Settings Display tab.

Battery-powered accessories connected to the monitor continue to charge while the monitor is in this mode and connected to AC power.

Note The monitor will not enter the Display power saving mode while an alarm condition is active or when NIBP intervals are in progress. In addition, the monitor will exit this mode if an alarm occurs.

The following actions will return the monitor display to the active state:

- Touch the screen
- Remove the temperature probe from the probe well
- Attach the SpO2 sensor to a patient
- Press 

Standby

The monitor is plugged into a power outlet, but the sensors and the display do not operate.

Note Because power is still available to charge the battery and power the monitor, the monitor is in Standby mode.

The monitor remains in Standby mode until you press . Settings for this mode can be changed in the Advanced Settings Display tab.

Power up the monitor

The monitor runs a brief diagnostic self-test each time it powers up.



WARNING Equipment failure risk. The monitor includes a fan that circulates air through the device. If the fan does not run when you power up the device, remove it from use and inform qualified service personnel immediately. Do not use the monitor until the problem is corrected.



WARNING To ensure patient safety, listen for two audible indicators (a piezo beeper and a speaker tone) and watch for visual alerts at power-up. Correct any system errors before using the monitor. In addition to the audible indicators, the monitor LED light bar illuminates to alert you of alarms. Amber indicates a low-level alarm. Flashing amber indicates a medium-level alarm. Flashing red indicates a high-level alarm.



WARNING Always observe the monitor during power-up. If any display fails to illuminate properly, or if an error code displays, inform qualified service personnel immediately, or call your nearest Welch Allyn Customer Service or Technical Support facility. Do not use the monitor until the problem is corrected.



Caution Always use the monitor with an adequately charged and properly functioning battery. For continuous monitoring, always connect to AC power.





Caution Use only a Class I (grounded) AC power cord for powering this monitor.

Press  to power up the monitor.

Following a successful self-test, the monitor displays the Welch Allyn logo, the LED light bar (located on the handle) flashes, and a power-up tone sounds. The startup screen then appears with the following banner across the bottom.

WelchAllyn Connex

If a system error is detected, the monitor becomes inactive until you press  or until the monitor shuts down automatically. The monitor displays a system fault message that contains a wrench icon  and a system fault code to aid service and engineers in diagnosing the problem.

Power down the monitor

1. Touch the **Settings** tab.
2. Touch the **Device** tab.
3. Touch **Power down**.

This power-down method, which places the monitor into Standby mode, ensures that patient measurements are retained in the monitor memory for a maximum of 24 hours. (These saved measurements are available for recall, printing, or to send electronically to the network.) This method also ensures that any configuration settings you have changed and saved will be maintained at the next startup.

Note Because power is still available to charge the battery and power the monitor, the monitor is in Standby mode.

Reset the monitor

If the monitor stops functioning, you can press and hold  for approximately 6 seconds to allow the hardware to completely cycle off and to reset the monitor configuration settings to the last saved default power-up configuration. The button is located on the side of the monitor.



Caution Do not use a long press of  to power down the monitor when it is functioning normally. You will lose patient data and configuration settings.

Note Because power is still available to charge the battery and power the monitor, the monitor is in Standby mode.

Set the date and time

1. Touch the **Settings** tab.
2. Touch the **Device** tab.
3. To change the date and time values: Touch the up and down arrow keys or touch  and enter a value.

Repeat for each value you want to change.

Note The date and time stamps on saved patient measurements will adjust in response to new date and time settings.

Enter clinician information

1. Go to the Clinician tab using one of these methods:
 - Touch the Clinician ID section (left edge) of the Device Status area on the Home tab.
 - Touch the **Settings** tab and then touch the **Clinician** tab.
2. To enter the clinician name, touch , located at the right of the text field, and enter characters.

You can enter up to 32 characters for the clinician's first and last name. Enter only 1 character for the middle initial.
3. To enter the clinician ID, use one of these methods:
 - Touch  and enter the ID.
 - Scan the clinician's barcode with a barcode scanner. The scanned ID appears in the field.
4. If prompted, enter your system password.
5. Touch **OK** to save your entries and return to the Home tab.

Set the default configuration

1. Touch the **Settings** tab.
2. Touch the **Device** tab.
3. Enter or adjust the desired settings you want to add or change.

Note The new settings appear as they are completed but are temporary until they are saved.
4. Touch **Save as default**.
5. Touch **OK** to confirm that you want to overwrite your previous settings and replace them with your current settings in the startup default configuration. Or touch **Cancel** to retain the previous settings.

The new settings are stored as the default startup settings once you restart the monitor.

Note If your monitor is connected to the network, the date and time settings are synchronized with the network settings.

Note The date and time stamps on saved patient measurements will adjust in response to new date and time settings.

Navigation

The monitor screen provides the interface that you use to complete your workflow. You access the monitor's features by touching the screen.

Home tab

The Home tab includes the following areas:

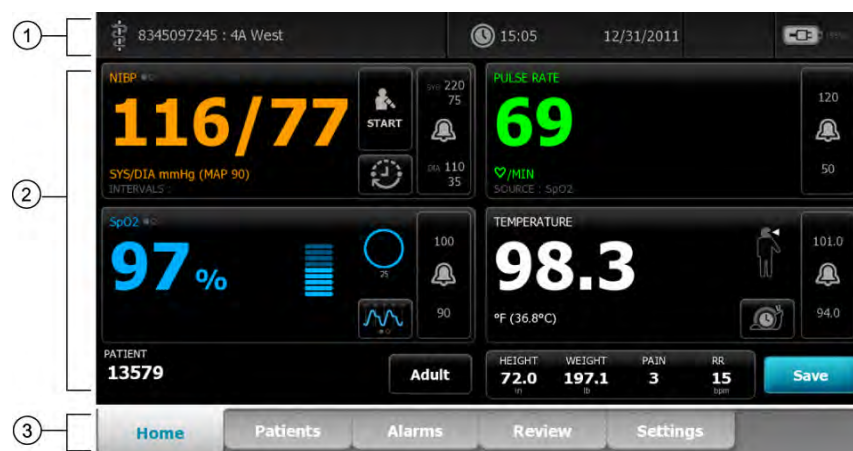

Item	Area
1	Device Status
2	Content
3	Navigation



Device Status area



The Device Status area, located at the top of the Home screen, displays the following monitor information, from left to right:

- Clinician identification. The format can be a name, ID number, or icon. Touch this area to navigate to the Clinician login.
- Device location.

- Time and date. Touch this area to navigate to date and time settings.
- Connection status (wired or wireless). The icons indicate which connection type, if any, is currently active.

Icon	Connection type
	Ethernet
	USB
	Wireless
Blank	No connection

- Process indicator. This indicator appears when system or patient data is transferred between the monitor and the network.
- Battery condition. Estimated battery capacity is displayed in hour(s):minute(s) format.

This area also provides:

- Interactive alarm and information messages.
- Shortcuts to some setting controls. For example, touching the Alarm icon displays the Alarms tab.

Battery status

The battery status indicator displays the state of the battery.

The battery status is represented by icons in the right corner of the Device Status area:

- The monitor is connected to a power outlet and the battery is charging or is fully charged. The estimated charge rate is displayed as a percentage of capacity.



- The monitor is not connected to a power outlet and is running on battery power. The estimated charge time remaining is displayed in the hour(s):minute(s) format. Each section of the battery status indicator represents a percentage of remaining charge.



- The monitor is connected to a power outlet but the battery does not maintain a charge (or has been removed).



When the battery is not being recharged and power becomes low, a low-priority alarm appears in the Device Status area.



Note Observe the remaining battery charge in the battery status indicator and plug the monitor into a power outlet as soon as you are able.

If the low-priority alarm is dismissed or if you take no action to charge the battery, a high-priority alarm appears when battery power is critically low. Plug the monitor into a power outlet immediately to prevent it from shutting down.



Alarm and information messages

The Device Status area provides alarm and information messages that are either temporary or exist as long as the condition to which the message applies remains. Alarm or information messages may also include controls and/or behavior that you can use to manage alarm and information messages.

When the monitor detects an alarm condition, an alarm message appears. When multiple alarms occur, the highest priority message appears. You can cycle through each alarm message by touching the multiple alarm toggle.

Information messages instruct you to interact with the monitor in a specific way or provide information that does not require action. You can dismiss an information message by selecting the control associated with the message or waiting for the message to time out.

Content area

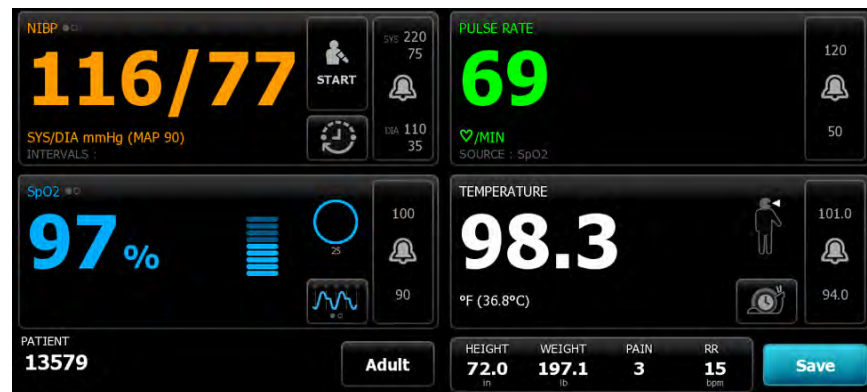

The Content area displays vital sign measurements. It also provides shortcuts to several controls.

The Content area includes the following frames:

- NIBP
- SpO2 with optional SpHb
- Pulse rate
- Temperature
- Patient
- Manual parameters (height, weight, pain, temperature, respiration, and BMI, depending on configuration)

The Content area also includes a **Save** button, which you use to manually save current measurements.

Save patient data

Patient data can be saved to the monitor.

After taking a patient reading, touch **Save**.

A message will appear indicating a successful or failed save.

Note You can configure some profiles and settings to automatically save measurements.

Navigation area



The Navigation area includes the following tabs:

- **Home:** Displays vital-sign measurements and provides shortcuts to several controls.
- **Patients:** Accesses the patient list, patient summary, patient modifiers, and manual parameters.
- **Alarms:** Accesses global alarm response and settings controls, plus alarm limits settings (available only in Monitor mode).
- **Review:** Prints, deletes, and sends patient data.
- **Settings:** Accesses device configuration settings.

To navigate to a tab, touch the tab in the Navigation area with the corresponding name. The active tab is highlighted.

Display lock

The display lock prevents clinician input, which may be useful when cleaning the display.

Note The lock feature is not a security mechanism.

The display locks when any of the following occur:

- You touch **Lock display now**.
- No interaction with the monitor occurs for the period specified in the Display tab. Use the Advanced tab to set or change the time it takes for the display to lock. (This requires the Advanced settings access code.)

Lock the display

Follow these steps to touch the screen without activating the controls.

1. Touch the **Settings** tab.
2. Touch the **Device** tab.
3. Touch **Lock display now**.

The following occurs:

- The Home screen appears.

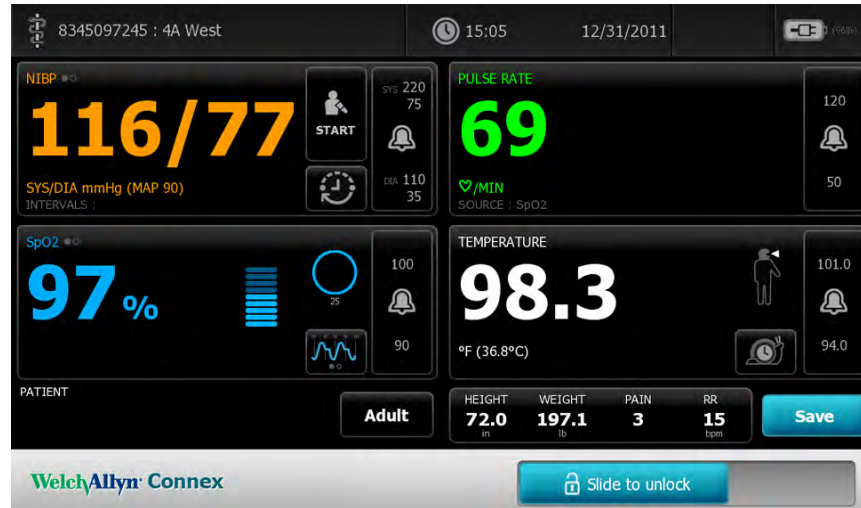

- A title bar with a sliding button and lock icon replaces the Navigation area, located at the bottom of the screen.
- Patient information no longer appears at the bottom left of the screen.
- Only **Slide to unlock** (located at the bottom right) responds to touch. All other controls on the screen are locked. If any area of the screen, other than the sliding button, is selected, a message appears.

Unlock the display

On the locked screen, touch and move **Slide to unlock** (located at the bottom right) to the rightmost position on the sidebar.

The following occurs:

- Patient information appears in the Patient frame.
- The Navigation area appears.
- Home tab controls are available for use.

The display also unlocks when any of the following occur:

- An alarm condition.
- An externally initiated action, such as taking or stopping an NIBP measurement or upgrading software.
- The monitor powers up.

Profiles

Profiles are variations of the Home tab. Each profile gives you access to a different set of features. Choose the profile that best suits your needs.

The monitor offers multiple profiles—including Monitor, Spot Check, and Triage—based on the model and any upgrade licenses you purchase.

Monitor profile

The Monitor profile enables you to use alarms and timed intervals. It is designed for continuous patient monitoring.

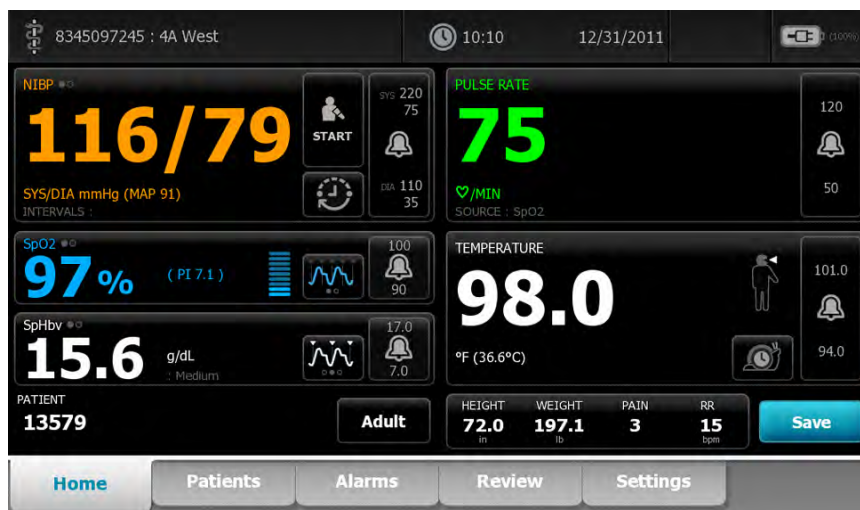

Spot Check profile

The Spot Check profile is optimized for clinicians who take spot-check vital readings and do not need automatic reading or alarm features.

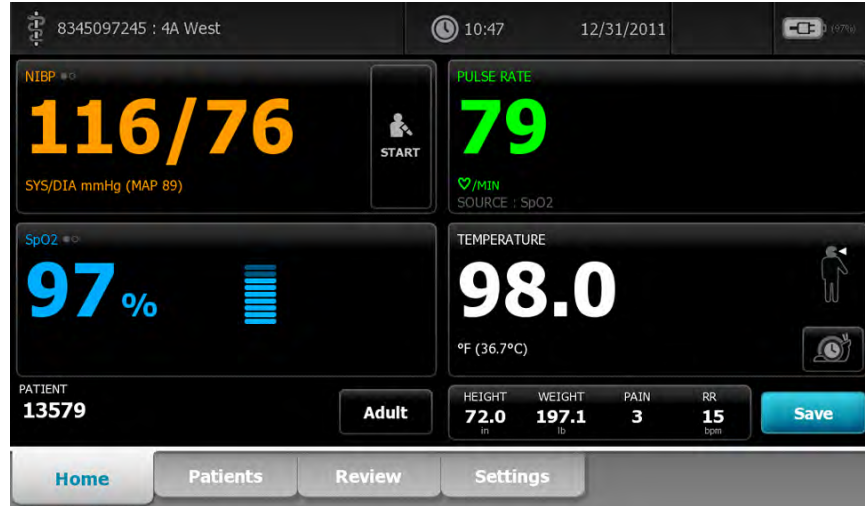

Triage profile

The Triage profile allows for vital signs capture without alarms or access to the Patients tab.

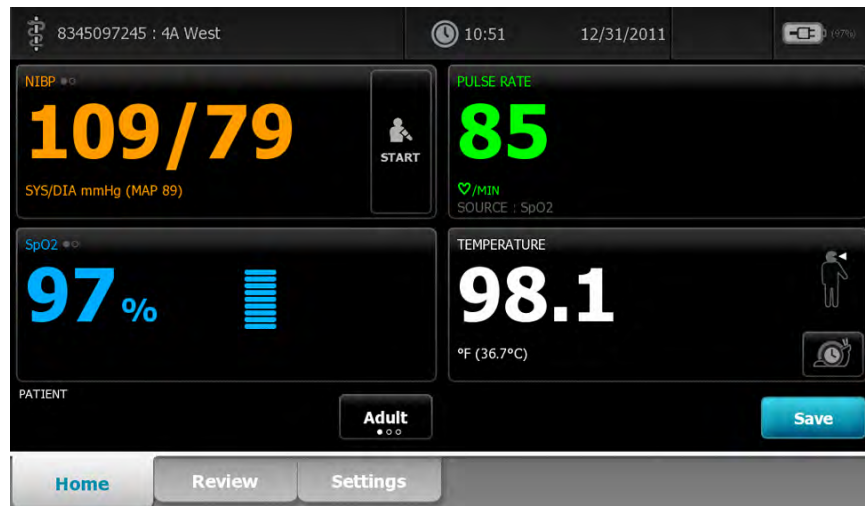

Profile feature comparison

The following table compares the features of the profiles.

Feature	Monitor	Spot Check	Triage
Take NIBP, SpO ₂ , temperature, and pulse rate readings	X	X	X
Take SpHb readings (Masimo only)	X		
Configure and use interval timing setting	X		
Observe and configure alarm limits	X		
Observe and respond to physiological alarms	X		
Change patient type (adult, pediatric, neonate)	X	X	X
View and enter manual parameters (height, weight, pain, respiration, temperature*, BMI**)	X	X	
Save currently displayed data to device memory	X	X	X
Save and review patient data	X	X	X
Access Patients tab	X	X	
Access Alarms tab	X		
Access Review tab	X	X	X
Access Settings tab	X	X	X

* Braun IR thermometers configured to work with the monitor transfer temperature data automatically to the Temperature frame. You can enter temperature manually if you take a patient temperature with a thermometer that is not connected to the monitor, and you have selected temperature as one of the four manual parameters to display.

** Body Mass Index (BMI) is calculated and transferred to the monitor only by an attached weight scale. You cannot enter or adjust BMI values. BMI displays on the Manual tab and in the Manual parameters frame if you have selected it as one of the four parameters to display.

Select a profile

Follow these steps to select a profile, which controls the appearance and functionality of the device.

1. Touch **Settings**.
2. Touch **Profiles**.
3. Touch the desired profile.
4. Touch **Home** to return to the Home tab.

Note Profiles cannot be changed while acquiring patient measurements or while unsaved patient measurements are on the display.

Using the keypad, keyboard, and barcode scanner

Open the numeric keypad



Touch any field that includes the numeric keypad icon .

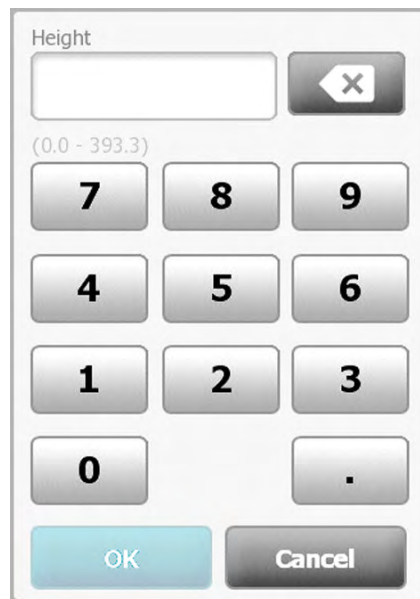

The numeric keypad appears.

Numeric keypad



The numeric keypad includes the following components:

Component	Name	Description
	Data field	Displays the numbers you enter. The field name appears above and the range of values you can enter appears below this field.
	Backspace key	When touched, removes the rightmost number from the data field.

Component	Name	Description
	Cancel button	When touched, the numeric keypad disappears and the selected number does not change.
	OK button	When touched, the numeric keypad disappears and the entered number appears in the associated frame or data field.

Enter a number

- With the numeric keypad open, touch a number or numbers.
The value must be within the range that appears below the data field.
- Touch **OK**.
 - If the value is within the required range and format, the numeric keypad disappears and the entered numbers replace the previous numbers.
 - If the number is not within the required range and format, **OK** remains inactive until you enter a valid number.

Close the numeric keypad

Touch one of the following:

- OK**: Exits the numeric keypad and inserts the number.
- Cancel**: Exits the numeric keypad without saving entered numbers.

Open the keyboard









Touch any field that includes the keyboard icon .

The keyboard appears.

Keyboard



The keyboard includes the following components:

Component	Name	Description
	Data field	Displays the characters you enter.
	Backspace key	When touched, removes the rightmost character from the data field.
	Space bar	When touched, enters a space in the data field.
	Shift key	When touched, enters the next letter as uppercase.
	Letters key	When touched, returns to the primary keyboard layout. The keyboard changes from normal layout when you touch one of these: <ul style="list-style-type: none"> • The symbols key • The diacritical marks key
	Symbols key	When touched, the keyboard displays symbols. The keyboard returns to its normal layout when you touch one of these: <ul style="list-style-type: none"> • Any symbol • The letters key • The symbols key <p>Note The symbols that display match the selected language.</p>
	Diacritical marks key (appearance varies in some languages)	When touched, the keyboard displays letters with diacritical marks. The keyboard returns to its normal layout when you touch one of these: <ul style="list-style-type: none"> • Any letter • The letters key • The diacritical marks key <p>Note This key appears only when the selected language uses diacritical marks.</p>
	Next button	When touched, accepts the entry for the current field, then clears the field to allow data entry for the next field.
	Cancel button	When touched, the keyboard disappears and the content of the data field remains the same.

Component	Name	Description
	OK button	When touched, the keyboard disappears and the entered characters appear in the data field.

Enter a letter or number

1. With the keyboard open, touch letters or numbers.
2. Do one of the following:
 - Touch **Next**. This control accepts the entry for the current field, then clears the data field to allow data entry in the next field.
 - Touch **OK**. The keyboard disappears and the entered characters appear in the data field.

Enter a symbol or special character

Note To return to the keyboard's normal layout, touch .

1. With the keyboard open, touch .
Symbols and special characters for the selected language appear.

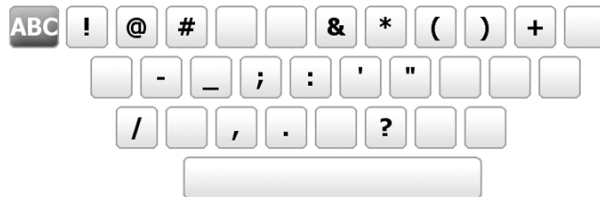

2. Touch the appropriate symbol or special character.
The keyboard returns to its normal layout.

Enter a diacritical mark

Note Keyboards with diacritical marks are available only for languages that use diacritical marks.

Note To return to the keyboard's normal layout without saving changes, touch .

Diacritical marks key	Language(s)
None (Not applicable)	Danish, English, Dutch, German, Italian
	French

Diacritical marks key	Language(s)
	Finnish, Norwegian, Spanish, Swedish
	Portuguese
	Polish
	Greek

1. With the keyboard open, touch the diacritical marks key. This key varies based on the language, as noted above.

The keyboard displays diacritical marks for the selected language and therefore varies from one language to another. On each diacritical marks keyboard, the letters key in the top left corner returns you to the standard keyboard.

2. Touch a diacritical mark.

The keyboard returns to its normal layout.

Close the keyboard

Touch one of the following:

- **Next:** Accepts the entry for the current field, then clears the field to allow data entry for the next field.
- **OK:** Exits the keyboard and inserts the data.
- **Cancel:** Exits the keyboard without saving entered data.

Use a barcode scanner

The monitor enables the scanning of patients' and clinicians' barcodes to enter ID information. The barcode scanner supports linear and two-dimensional barcodes.

If you haven't done so already, attach the barcode scanner to the monitor. Use the instructions to attach an accessory.

Note Refer to the manufacturer's directions for use to ensure that the scanner is set to USB Com Emulation mode.

1. Remove the barcode scanner from its holder.
2. Hold the scanner approximately 6 inches (15.4 cm) from the barcode and squeeze the trigger so that the light from the scanner appears on the barcode.

Once the scanner completes a successful barcode reading, the ID appears in the targeted area (Patient frame, data field, or Device Status area). See additional notes below.

If the scanner has difficulty reading the barcode, slowly adjust the distance and the angle between the scanner and the barcode while squeezing the scanner trigger. If it continues to have difficulty, verify that the barcode is as flat as possible.

Note You can scan a patient's barcode from the Home tab or the Summary tab. The scanned ID appears in the Patient frame on the Home tab and in the Patient ID field on the Summary tab.

Before you scan a barcode on the Summary tab, touch the keyboard icon in the Patient ID field. To return to the Home tab and begin taking patient measurements, touch **OK**.

Note Scanning a clinician ID while the Clinician ID pane is open places the scanned ID into the Clinician ID section of the Device Status area. Touch **OK** to return to the Home tab and to begin taking patient measurements.

Note Use the Advanced settings Data Management tab to change the appearance of the Clinician ID if you do not want your ID to appear in the Device Status area. (This requires the Advanced settings access code.) However, this information is still retained in the monitor memory for recall, printing, or to send measurements electronically to the network.

Patient data management

Patient data is managed through the Patients tab.

From this tab, you can do the following:

- Retrieve a patient list from the network or manually create a patient list.
- Select a patient from the list.
- Scan a patient ID with the barcode scanner and return an Admit/Discharge/Transfer (ADT) patient name match.
- Enter additional patient information such as modifiers and manual parameters.





Caution Verify patient identity on the monitor after manual or barcode entry and before printing or transferring patient records.

Add a patient to the patient list

Note If the monitor is configured to retrieve the patient list from the network, you cannot manually add a patient to the patient list.

1. Touch the **Patients** tab.
2. Touch **Add**.

3. Touch  and then enter patient information. Touch  to cycle through the patient data fields.

Note You can use a barcode scanner to enter a patient ID in the Patient ID field. Touch  in the Patient ID field, scan the barcode, and touch **OK**.

4. Touch **OK** to return to the Home tab.
The information is saved.



Caution Verify patient identity on the monitor after manual or barcode entry and before printing or transferring patient records.

Load patient data with the barcode scanner

You can use a barcode scanner to query existing patient records and perform an ADT patient name match.

Note If the monitor is connected to the network, the monitor can receive a patient name from patient records associated with a scanned ID number.

1. Ensure that you are on the Home tab.
2. Scan the patient's barcode with the barcode scanner.

The Patient ID appears in the Patient frame.



Caution Verify patient identity on the monitor after manual or barcode entry and before printing or transferring patient records.

Select a patient

1. Touch the **Patients** tab.
2. If the monitor is connected to the network, touch **Retrieve list** on the List tab.
The monitor retrieves the patient list from the network.
3. From the patient list, touch the patient's identifier (name, ID number, or location).
The patient's identifier is determined in Advanced settings.
4. Touch **Select**.

Note In the Spot Check and Triage profiles, previous patient data will be overwritten by a new save. In the Monitor profile, selecting a new patient will clear the current patient data and readings.

Patient data can be sorted in ascending or descending order by selecting the heading row and touching ▲ or ▼.

Manage patient records

Patient records can be sent to the network, printed, or deleted.

1. Touch the **Review** tab.

Note Measurements that triggered a physiological alarm are highlighted on this tab.

<input checked="" type="checkbox"/>	Patient	Date / Time	NIBP	Temp	PR	SpO2	SpHb	Ht Wt P RR
<input checked="" type="checkbox"/>	13579	12/31/2011 13:33	113/73(87)	36.5	88	96	15.5	182.9/89.4/3/15
<input checked="" type="checkbox"/>	13579	12/31/2011 13:36	141/72(95)	36.6	87	95	14.2	182.9/89.4/3/15
<input checked="" type="checkbox"/>	13579	12/31/2011 13:37	108/64(79)	36.3	90	95	14.1	182.9/89.4/3/15
<input checked="" type="checkbox"/>	13579	12/31/2011 13:38	117/75(89)	36.3	86	97	14.0	182.9/89.4/3/15
<input checked="" type="checkbox"/>	13579	12/31/2011 13:39	117/77(90)	36.4	91	96	13.9	182.9/89.4/3/15
<input checked="" type="checkbox"/>	13579	12/31/2011 13:41	120/68(85)	36.2	90	96	13.9	182.9/89.4/3/15

Send Print Delete View All

Home Patients Alarms **Review** Settings

2. Select patients by touching the check box next to their names.
3. Touch **Send** to transmit the records to the network, **Print** to print the records, or **Delete** to permanently remove the records as desired.



Caution Verify patient identity on the monitor after manual or barcode entry and before printing or transferring patient records.



Caution Always visually verify the printed patient records.

Note

The  icon indicates the records have been sent to the network.

Note

You can configure some profiles and settings to automatically send measurements to the network.

Note

Patient measurements older than 24 hours are automatically deleted from the patient records list on the Review tab.

Note

The date and time stamps on saved patient measurements will adjust in response to new date and time settings.

Print patient data

1. Touch **Review** from the Home tab.
2. Touch next to the names of the patients whose data you want to print.

Once selected, a check mark will be added to the box .

3. Touch **Print**.
4. Confirm the number of records you want to print and touch **OK**.

The data is sent to the printer.



Caution Verify patient identity on the monitor after manual or barcode entry and before printing or transferring patient records.

Printer

The monitor prints to a strip to create printouts of patient information and data.

Note The sample printouts below are English, but the language in the printouts is defined by the language selected on the monitor.

Patient:			
ID: 13579			
Room/Bed:			
Clinician:			
SYS/DIA (MAP) PR	SpO2	Temp	
(mmHg)	(BPM)	(%)	(°F)

12/31/2011 @ 07:46			
	78		97
12/31/2011 @ 07:46			
86/55 (65)	78		97
12/31/2011 @ 07:46			
110/71 (84)	82		97
12/31/2011 @ 07:46			
102/63 (76)	78		97
12/31/2011 @ 07:46			
105/67 (79)	80		96
12/31/2011 @ 07:46			
100/64 (76)	77		97

Continuous monitoring report

Patient:		
ID: 13579		
Room/Bed:		
Clinician:		
12/31/2011 @ 08:53		
SYS	106	mmHg
DIA	68	mmHg
MAP	81	mmHg
PR	71	BPM
SpO2	??	
Temp	97.8	°F
Height	177.8	cm
Weight	68.0	kg
Pain	0	
RR	12	bpm

Spot Check report

Delete a patient from the list

1. Touch the **Patients** tab.
2. From the List tab, touch the patient record you want to delete.
3. Touch **Delete**.

At the Delete Confirmation window, touch **OK** to permanently delete the selected patient. Touch **Cancel** to cancel the deletion.

Note Deleting a patient from the Patients List does not delete saved records. Touch **Review** to see or delete saved records.

Note For monitors connected to the network, deleting a patient on the monitor does not affect data on the network.

Modifiers

The Modifiers tab enables you to enter additional information for current measurements.

The screenshot shows the 'Modifiers' tab selected in a patient data management application. The interface is divided into two main sections: 'NIBP' and 'O2'. The 'NIBP' section includes three dropdown menus: 'Cuff site', 'Cuff size', and 'Patient position'. The 'O2' section includes three input fields: 'Flow rate', 'Concentration', and 'Method'. At the bottom right of the form area, there are two buttons: 'OK' (highlighted in blue) and 'Clear'. The bottom navigation bar shows five tabs: 'Home', 'Patients' (highlighted in blue), 'Alarms', 'Review', and 'Settings'.

Set modifiers

1. Touch the **Patients** tab.
2. Touch the **Modifiers** tab.
3. Adjust the NIBP, O2, and Temperature settings as required.
4. Touch **OK** to accept the changes and return to the home screen, or touch **Clear** to delete all entries.

The Modifier settings clear after a power cycle, after you clear the Home tab, or after you select a new patient.

Alarms

The monitor presents physiological alarms and technical alarms. Physiological alarms occur when vital sign measurements fall outside of set alarm limits, but they occur only in the Monitor profile. Technical alarms occur in all profiles.

Note The three modes of data communication—USB, Ethernet, and IEEE 802.11—are not intended for real-time alarms.

Alarm types

Type	Priority	Color	Alarm audio tone
<ul style="list-style-type: none"> NIBP, SpO2, or SpHb limit exceeded Some technical alarms 	High	Red	10-pulse tone
<ul style="list-style-type: none"> Pulse rate limit exceeded Some technical alarms 	Medium	Amber	3-pulse tone
<ul style="list-style-type: none"> Temperature limit exceeded Some technical alarms 	Low	Amber	2-pulse tone or 1-pulse tone

Alarm notification locations



WARNING If you are relying on visual alarm notifications, maintain a clear line of sight with the monitor and/or Nurse Call. If you are relying on audio alarm notifications, ensure that you can hear audio alarms from where you are. Set the volume as needed considering the environment and ambient noise levels.

Nurse Call

When the Nurse Call cable is connected and Nurse Call has been enabled, the monitor immediately notifies the Nurse Call system when an alarm occurs. Nurse Call notification settings are specified in the Advanced settings.

LED light bar

The light bar on the handle of the monitor illuminates as follows:

- Flashing red for high priority alarms
- Flashing amber for medium priority alarms

- Constant amber for low priority alarms

Home tab

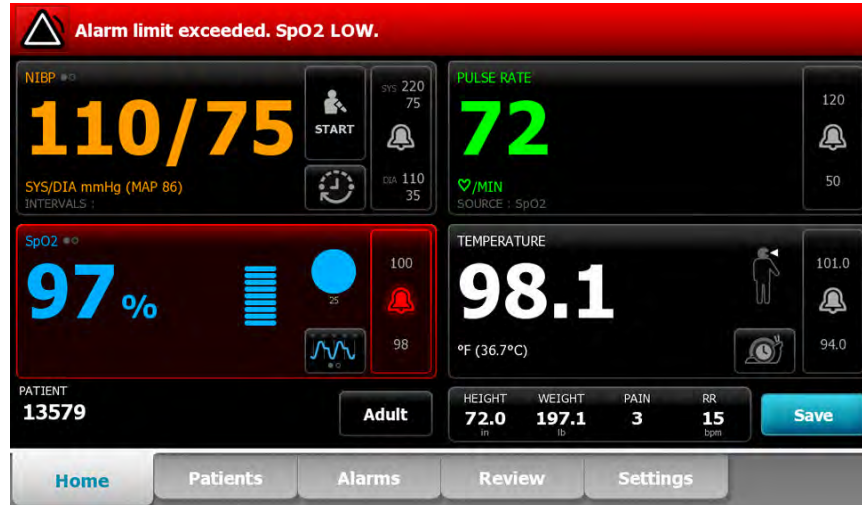

Home tab notifications





Notification	Description
Device Status area	The area changes color and displays a message with an accompanying status icon or button. If the alarm tone is in a pause interval, a timer countdown appears. If multiple alarms and information messages are active, the Device Status area shows the highest priority alarm. If the alarms are equal in priority, the most recent alarm message appears. You can cycle through the messages for each active alarm.
Parameter frame	The background color changes. Touch this area to pause or turn off an alarm audio tone. Visual indicators and Nurse Call notification will persist during an audio paused condition.
Alarm Limit control	The icon in this control indicates the status of the alarm limit settings. Red and amber icons indicate measurements that have exceeded alarm limits. Touch this control to navigate to a parameter-specific tab where you can modify alarm limit settings.

Icons on the Home tab

Icons in parameter frames

The icons in the parameter frames indicate alarm notification settings. When alarm limits are on, the icons will be black and white until an alarm occurs. Then, the icons will change color to indicate the priority of the alarm. Red icons represent high priority alarms, and amber icons represent medium or low priority alarms.





Icons in parameter frames

Icon	Name and status
	Alarm off. No visual or audio alarms or Nurse Call notification will occur for this parameter.
	Alarm on. Audio and visual notifications and Nurse Call are enabled.
	Alarm audio off. Only visual notifications, including Nurse Call, will occur.
	Alarm audio paused. The audio tone is paused for a period ranging from 90 seconds to 15 minutes. The icon remains until the paused time counts down to 0.

Icons in the Device Status area

The icons in the Device Status area are black and white, but the background area changes colors to indicate the alarm priority. Messages accompany these icons. These icons can be controls or status indicators.

Icons in the Device Status area

Icon	Name and status
	Alarm active. One or more alarms are active. Touch this icon to pause or turn off the audio tone.
	Alarm audio off. Audio signals are disabled, but alarm limits and visual alarm signals remain active.
	Multiple alarms toggle. Touch this icon to cycle through the messages for each active alarm.
	Alarm audio paused. The audio tone is paused for a period ranging from 90 seconds to 15 minutes. The icon remains until the paused time counts down to 0. Touch this icon to reset the pause interval. The pause interval is determined by settings in the Advanced tab.

Reset (pause or turn off) audio alarms



Audio alarm characteristics

- After you reset an audio alarm, some tones do not return, but others return after a pause interval if the condition that caused the alarm persists. Settings in the Advanced tab determine the length of the pause interval.
- If a new alarm condition occurs during a pause interval, a new audio tone occurs.
- If an audio alarm is not paused or turned off after a period of time, a buzzer accompanies the tone.



Pause or turn off an audio alarm

- In the Device Status area, touch .

 - Visual indications remain in the parameter frame until the condition is corrected or until the next measurement is taken.

In the Device Status area, if the icon changes to  and the message remains, the timer counts down and the audio tone returns after a pause interval. You can touch  again to restart the timer.

If you responded to an NIBP alarm and multiple NIBP limits have been exceeded, the first audio tone and message go away, but another NIBP limit message shows with a countdown timer. A new NIBP audio tone sounds after the countdown unless you touch  to dismiss each remaining NIBP limit message.
- If multiple alarms are active, a multiple alarm toggle will appear in the Device Status area. Respond to multiple alarms as follows:

 - Touch  in the Device Status area. (See note below.)
 - Read the alarm message for the second alarm.
 - Touch .
 - Continue to touch multiple alarm toggle buttons and to reset tones until you have read all of the messages.

Note

The multiple alarm toggle button will display the number of active alarms inside the alarm icon. A set of dots indicating the display order of alarms from highest (left) to lowest (right) priority (as well as the most recent in the case of multiple alarms of the same priority) will appear below it.

Adjust vital sign alarm limits

You can adjust vital sign alarm limits or turn off alarm limit checking for individual parameters.



WARNING Alarm limits are user adjustable. All alarm limit settings should take into account the patient's condition and acute care needs. Appropriate alarm limits should be set accordingly for each patient.



Caution Loss of power will cause the monitor to return to default settings. Each time you power up the monitor, you must set alarm limits appropriate for your patient.

1. On the Home tab, touch the alarm limits control in the selected parameter frame. For example,

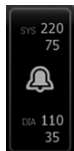



to adjust the NIBP alarm limits, touch

2. Adjust vital sign alarm limits.

- To adjust a limit: Enter the desired upper and lower alarm limits using the up/down arrow keys or the keypad.



- To turn alarm limits off or on for the vital sign: Touch  or . This button toggles to display the current alarm state.

If you turn off alarm limit checking for a vital sign, no visual or audio alarm signals will



occur for those limits. If alarm limit checking is off, the icon changes to  on the Home tab in the parameter frame.

Modify audio alarm notification

You can modify the volume of all audio alarms.

Note If the *Allow user to turn off general audio* option has been selected in Advanced settings, you can turn off audio alarms, but turning off alarms is not recommended in some circumstances, such as unattended monitoring.



WARNING The alarm volume should be loud enough for you to hear it from where you are. Set the volume considering the environment and ambient noise levels.

As you are working in the Alarms tab, parameter measurements appear across the top of the tab.

1. Touch the **Alarms** tab.



2. On the **General** tab, modify audio alarm notification.
 - To enable or disable audio alarms, select **Alarm audio on** or **Alarm audio off**. If you turn off audio alarms, visual alarm signals still occur in the LED light bar, Device Status area, and on the Home tab in parameter frames.



The  in the Device Status area indicates alarm audio turned off, and a similar bell



will appear in the parameter frames. If an alarm condition occurs, the bell will be red or amber in the alarming frame, according to the priority of the alarm, as shown here:



- To modify the volume of audio alarms: Select a volume level. An audio tone sounds briefly to indicate the volume level.

Note Periodically test the speaker by selecting different speaker volumes and listening for the different tones.

Alarm messages and priorities

The following tables list the physiological and technical alarm messages and their priority.

Physiological alarms

Alarm messages	Priority
Alarm limit exceeded. NIBP systolic HIGH.	High
Alarm limit exceeded. NIBP systolic LOW.	High

Alarm messages	Priority
Alarm limit exceeded. NIBP diastolic HIGH.	High
Alarm limit exceeded. NIBP diastolic LOW.	High
Alarm limit exceeded. NIBP MAP HIGH.	High
Alarm limit exceeded. NIBP MAP LOW.	High
Alarm limit exceeded. Pulse rate HIGH.	Medium
Alarm limit exceeded. Pulse rate LOW.	Medium
Alarm limit exceeded. SpO2 HIGH.	High
Alarm limit exceeded. SpO2 LOW.	High
Alarm limit exceeded. SpHb HIGH.	High
Alarm limit exceeded. SpHb LOW.	High
Alarm limit exceeded. Temperature HIGH.	Low
Alarm limit exceeded. Temperature LOW.	Low

Technical alarms

Alarm messages	Priority
Low battery 5 minutes or less remaining.	High
Searching for pulse signal.	High
Communications module did not power on properly. Power down the device.	High
Network not found; check network cable connections.	Low
Powering down. Call for service.	Low
Battery is absent or faulty. Call for service.	Low
NIBP air leak; check cuff and tubing connections.	Low
NIBP not functional. Call for service.	Low
Unable to determine NIBP; check connections and tubing for kinks.	Low
Incorrect NIBP cuff size; check patient type.	Low
Inflation too quick; check NIBP cuff and tubing connections.	Low
Unable to determine NIBP; check inflation settings.	Low

Alarm messages	Priority
SpO2 not functional.	Low
Attach SpO2 sensor to monitor.	Low
Replace the SpO2 sensor.	Low
Set date and time.	Low
Maximum number of patient records saved. Oldest record overwritten.	Low
Unable to access patient information.	Low
Connect temperature probe.	Low
Insert correct color coded probe well.	Low
Replace temperature probe.	Low
Temperature not functional. Call for service.	Low
Retry temperature measurement.	Low
Temperature time limit exceeded. Retry temperature measurement.	Low
Low battery; plug into outlet.	Low
Printer door is open; close to continue.	Low
Printer not functional. Call for service.	Low
Out of paper.	Low
Printer too hot; wait to retry.	Low
Radio not functional. Call for service.	Low
Radio error. Power down and restart.	Low
Unable to establish network communications. Radio out of network range.	Low
Unable to establish network communications. Call for Service.	Low
Unable to establish network communications. Call for Service.	Low
Radio software upgrade failed.	Low
Unable to load configuration; using factory defaults.	Low
Functional error. Call for service.	Low
External device not recognized.	Low
Incompatible Welch Allyn device.	Low

Alarm messages	Priority
USB Communication failure.	Low
Low battery 30 minutes or less remaining.	Low
Low SpHb signal quality. Check sensor.	Low
Low SpO2 signal quality. Check sensor.	Low
Low perfusion. Check sensor.	Low
Replace the SpO2 cable.	Low
SpO2 mode only. Check sensor or cable.	Low
SpO2 sensor expires in....	Low
Unexpected restart occurred. Call for service.	Low
Weight scale not functional. Call for service.	Low

Nurse call

The monitor can be connected to a Nurse Call system through a cable that connects to the Nurse Call connector.

When the Nurse Call cable is connected and Nurse Call is enabled, the monitor immediately notifies the Nurse Call system when a physiological alarm that exceeds the preset threshold occurs. The Nurse Call system is also synchronized with the flashing LED lightbar and audible alerts on the monitor.

Nurse Call thresholds are set in the Advanced Settings.

To connect the monitor to a Nurse Call system, you must have a cable that has been adapted to your Nurse Call system (REF 6000-NC), rated 25V AC or 60V DC maximum at 1A maximum. For ordering information, see *Approved Accessories* in the Appendix.



WARNING Do not rely exclusively on Nurse Call for patient monitoring. Although the Nurse Call option enables remote notification of an alarm condition, it is not intended to replace appropriate bedside patient monitoring by trained clinicians.

Note When a patient alarm occurs, touching the alarm icon in the Device Status area pauses the alarm tone for a period ranging from 90 seconds to 15 minutes, as specified in Advanced settings, but the visual alarm indicator(s) on the monitor and Nurse Call continue.

Patient monitoring

NIBP

Noninvasive Blood Pressure (NIBP) frame

From the NIBP frame, you can measure blood pressure.

Located in the upper left corner of the Home tab, the NIBP frame contains data and features relevant to noninvasive blood pressure measurement. The frame provides different features based on the profile you are using.

NIBP frame in Monitor profile

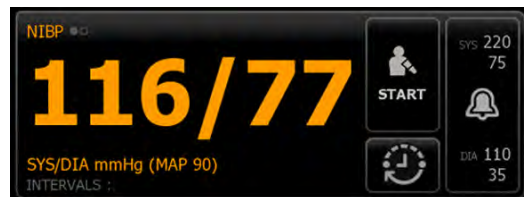

NIBP frame in Spot Check and Triage profiles

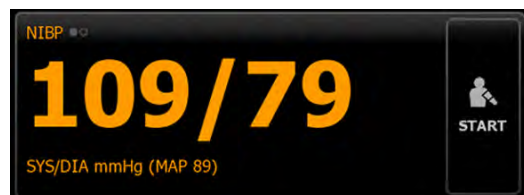



NIBP measurement display

In all profiles, the frame can display systolic and diastolic measurements, and MAP calculations. You can configure the default view in Advanced settings.

View indicator





Touch the NIBP frame to toggle between views.

- NIBP view 1  displays the SYS/DIA measurements as the primary content and the MAP calculation as secondary content.

- NIBP view 2  displays the MAP calculation as the primary content and the SYS/DIA as secondary content.

Buttons

The buttons on the right side of the frame enable you to do different tasks depending on the profile you are using. The availability of functions depends on which profile is selected. See the Profiles section for more information.

Button name	Button image	Description
Start/Stop		Touch to start a manual measurement or a cycle of automatic measurements.
		Touch to stop a measurement that is in progress.
Interval		Automatic measurements are off.
		Automatic measurements are on.
Alarm Limit control		Touch the button to display the Alarms tab.

Select a cuff



WARNING Use only blood pressure cuffs and hoses listed as approved accessories to ensure safe and accurate NIBP measurements.



WARNING Never use an adult or pediatric monitor setting or cuff for an NIBP measurement on a neonatal patient. Adult and pediatric inflation limits can be excessive for neonatal patients, even if a neonatal cuff is used. Neonates are defined in the AAMI SP10:2002 standard as children 28 days or less of age if born at term (37 weeks gestation or more); otherwise, up to 44 gestational weeks.



Caution Correct sizing of the blood pressure cuff is important for accurate blood pressure readings. A cuff that is too small might provide false high readings, while a cuff that is too large might provide false low readings.

The monitor uses the oscillometric method to determine blood pressure; therefore, if the cuff extends to the antecubital fossa (bend in the elbow), you can still acquire an accurate blood pressure reading.

Before taking an NIBP measurement, follow these steps to select the appropriate cuff for the patient.

1. Measure the circumference of the patient's bare upper arm, midway between the elbow and shoulder.
2. Choose the appropriate cuff size based on the circumference measurement. If the circumference of the patient's arm falls between two cuff sizes, use the larger cuff size.
3. Wrap the cuff around the patient's bare upper arm and verify that the artery index marker lies somewhere between the two range markings on the cuff.

Cuff measurements

The following tables provide measurements for Welch Allyn blood pressure cuffs.

One-piece cuff measurements

Cuff Size	Circumference (cm)	Circumference (in)
Infant	9.0 – 13.0	3.5 – 5.1
Small child	12.0 – 16.0	4.7 – 6.3
Child	15.0 – 21.0	5.9 – 8.3
Small adult	20.0 – 26.0	7.9 – 10.2
Adult	25.0 – 34.0	9.8 – 13.4
Large adult	32.0 – 43.0	12.6 – 16.9
Thigh	40.0 – 55.0	15.7 – 21.7

Neonatal soft disposable cuffs with male Luer slips

Cuff Size	Circumference (cm)	Circumference (in)
NEO 1	3.3 – 5.6	1.3 – 2.2
NEO 2	4.2 – 7.1	1.6 – 2.8
NEO 3	5.4 – 9.1	2.1 – 3.6
NEO 4	6.9 – 11.7	2.4 – 4.6
NEO 5	8.9 – 15.0	3.5 – 5.9
Multi-pack	1 of each	1 of each

For ordering information, see *Approved Accessories* in the Appendix.

Position the cuff

Note The monitor and cuffs were validated using the bare upper arm site.



WARNING Patient injury risk. Do not use the NIBP for continuous monitoring without frequently checking the patient's limb. When a patient is being monitored frequently or for a prolonged period, regularly remove the cuff to inspect it and to check the cuff site for ischemia, purpura, or neuropathy.



WARNING Inaccurate measurement risk. Do not place the cuff where it can disturb proper circulation. Do not place the cuff on any area where circulation is compromised or on any extremity used for intravenous infusions. Do not use an SpO2 finger clip sensor and a blood pressure cuff simultaneously on the same limb. Doing so may cause a temporary loss of pulsatile flow, resulting in either no reading or an inaccurate SpO2 or pulse rate until the flow returns.



WARNING The blood pressure cuff must be properly positioned to ensure blood pressure accuracy and patient safety. Wrapping the cuff too loosely (preventing proper inflation) may result in inaccurate NIBP readings.



Caution If a site other than the bare upper arm is used, the blood pressure measurements may be different. It is important to document the alternate site on the patient record.



Caution To minimize inaccurate measurement, limit patient movement during an NIBP measurement cycle.

Before taking an NIBP measurement, follow these steps to properly attach the cuff to the patient.

1. Position the cuff on the patient's bare upper arm midway between the shoulder and the elbow.
2. Wrap the cuff snugly so that there is room for no more than two fingers between the cuff and the patient's bare upper arm.
3. Position the alignment mark on the cuff directly over the brachial artery.
4. Ensure that the blood pressure tubing has no kinks or twists.

Note In situations where you cannot position the cuff level with the heart, you should adjust the measurements as follows for greater accuracy. For each inch (2.54 cm) that the cuff is above the level of the heart, add 1.8 mmHg to the displayed reading. For each inch (2.54 cm) that the cuff is below the level of the heart, subtract 1.8 mmHg from the displayed reading. It is important to document the adjustment on the patient record.

NIBP measurement

The monitor enables you to take manual and automatic NIBP measurements.



WARNING NIBP readings may be inaccurate for patients experiencing moderate to severe arrhythmia.



WARNING Do not allow a blood pressure cuff to remain on neonatal patients more than 90 seconds when inflated above 5 mmHg. Do not allow a blood pressure cuff to remain on the adult patients more than 3 minutes when inflated above 15 mmHg. Excessive cuff tightness may cause venous congestion, peripheral nerve injury, discoloration of the limb, and patient distress.



WARNING Inaccurate measurement risk. Pulse rate measurements generated through the blood pressure cuff or through SpO2 are subject to artifact and might not be as accurate as heart rate measurements generated through ECG or through manual palpation.



WARNING Use caution when measuring blood pressure using oscillometric blood pressure devices in severely ill neonates and pre-term infants because these devices tend to measure high in this patient population.



Caution Inaccurate measurement risk. Any external compression of the blood pressure hose or cuff may cause system errors or inaccurate measurements.

At the start of a measurement, the monitor inflates the cuff to the appropriate level. In the NIBP frame, the systolic display shows the cuff inflation pressure while the blood pressure measurement is in progress.

The monitor measures blood pressure as the cuff is inflating. If patient movement, excessive noise, or an arrhythmia prevent the monitor from determining the blood pressure while the cuff is inflating, the monitor attempts to measure the blood pressure while deflating the cuff.

When the measurement is complete, the NIBP frame displays the measurement until you save it to the patient's record or you start another NIBP measurement.

Note The Pediatric and Adult blood pressure modes are supported on patients 29 days and older. The Pediatric mode gives you the option of setting a lower initial inflation pressure when using the StepBP deflation and not SureBP.

Note Use dual-lumen tubes for adult and pediatric blood pressure measurements and single-lumen tubes for neonate blood pressure measurements. Mismatching tube types, patient types, and algorithms causes an information message to appear in the Device Status area. For neonate patients, set the NIBP settings as follows: Patient = Neonate, Tube type = 1 tube, Algorithm = Step.

Note Welch Allyn uses the following definition of Neonate: Children 28 days or less of age if born at term (37 gestation or more); otherwise, up to 44 gestational weeks.

Take a manual NIBP measurement



WARNING Patient injury risk. Never install Luer Lock connectors on Welch Allyn blood pressure cuff tubing. Using these connectors on blood pressure cuff tubing creates the risk of mistakenly connecting this tubing to a patient's intravenous line and introducing air into the patient's circulatory system.



Caution Inaccurate measurement risk. Any external compression of the blood pressure hose or cuff may cause system errors or inaccurate measurements.

1. Properly size the blood pressure cuff and position it around the patient's bare upper arm.
2. Touch **Start** to take a measurement.

Interval NIBP measurement

The monitor can take NIBP measurements automatically based on intervals you choose.

The Intervals tab provides all interval features.

From this tab, you can do the following:

- Configure intervals
- Turn off intervals
- Configure the monitor to print automatic measurements as they are completed

When the measurement is complete, the NIBP frame displays the measurement until the next measurement is complete.

Note During intervals, each automatic and manual save of patient measurements clears all measurements from Manual parameters frame.



The  button changes to a timer (), which counts down to the next automatic measurement.

Automatic measurements continue until you turn off intervals.



WARNING Patient harm risk. Do not use intervals on neonates out of earshot. Verify that audio can be heard from where you intend to be.

Automatic print on interval

The printer can be set to automatically print patient data at each interval.

1. Touch the **Settings** tab.
2. Touch the **Intervals** tab.
3. Touch the box next to Automatic print on interval.

Automatic intervals

You can configure the monitor to take automatic NIBP measurements at consistent intervals.

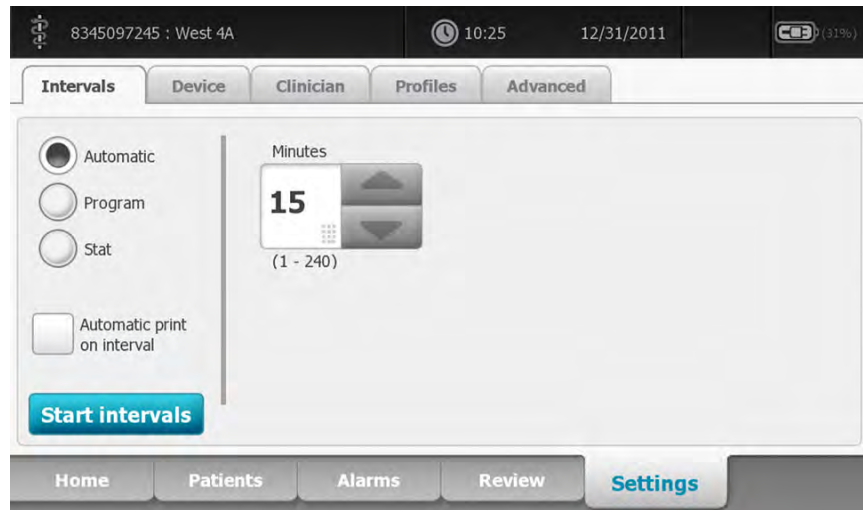

Note An alarm does not turn off intervals. Subsequent automatic measurements continue to occur as scheduled.

Start automatic intervals

Follow these steps to configure the monitor to take NIBP measurements at consistent intervals.

1. Properly size the blood pressure cuff and position it around the patient's bare upper arm.
2. On the Home tab, touch .
3. Select **Automatic**.
4. Use the numeric keypad to enter the length of time between NIBP measurements.
5. Touch **Start intervals**.

Note Intervals are not available in all profiles. See the Profiles section for more information.

Program intervals

You can configure the monitor to take automatic NIBP measurements at variable intervals. The monitor comes with preset interval programs that can be edited to meet your needs. The numbers below the program name indicate the length of time between each interval in the cycle.

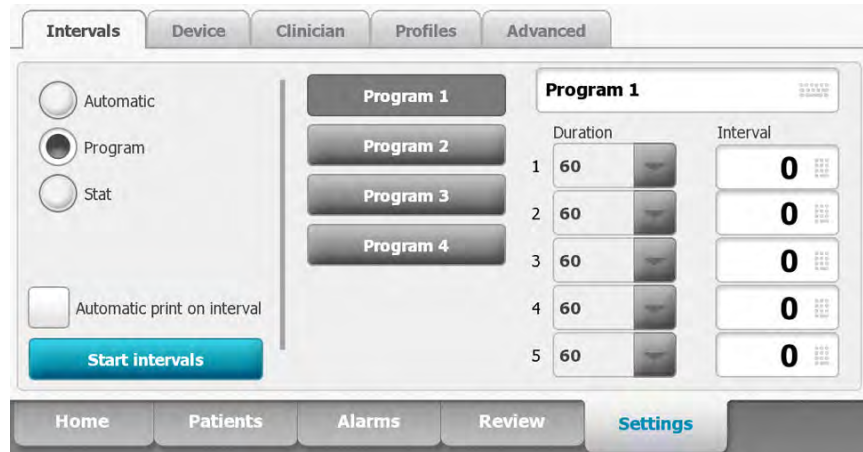

Start program intervals

Follow these steps to configure the monitor to take automatic NIBP measurements at variable intervals.

1. Properly size the blood pressure cuff and position it around the patient's bare upper arm.





2. On the Home tab, touch .
3. Select **Program**.
4. Touch the desired program.
5. Touch **Start intervals**.

Create a new program interval or edit an existing program

Follow these steps to create or edit a program interval.



1. On the Home tab, touch the interval button ( or ).
2. Select **Program**.
3. Touch the desired program.
4. Touch the keyboard icon and enter the desired program name.
5. Enter the desired duration and interval settings.
6. Touch **Start Intervals**.

The new intervals take effect at the start of the next NIBP measurement.

Stat intervals

You can configure the monitor to take NIBP measurements continuously.



When you select the Stat option in the Intervals tab, the monitor takes repeated NIBP measurements for 5 minutes, starting a new cycle each time the cuff deflates below safe venous return pressure (SVRP) for 2 seconds.



WARNING Patient injury risk. If you use Stat mode repeatedly, periodically observe the patient's limb to ensure that circulation is not impaired and that the cuff remains in place. Prolonged impairment of circulation or improper cuff position can cause bruising.

Current cuff pressures are not dynamically displayed during a Stat reading. The Home tab displays the NIBP reading from the previous cycle until the current cycle finishes.



Note If you are in Stat intervals, you can stop intervals by touching . If you touch the button twice, you will restart Stat intervals. The control toggles between STOP and START with each touch.

Start Stat intervals

Follow these steps to start Stat intervals.

1. Properly size the blood pressure cuff and position it around the patient's bare upper arm.
2. Select **Stat**.
3. Touch **Start intervals**.

Stop automatic measurements

Follow these steps to turn off intervals.

1. On the Home tab, touch the interval timer button (.
2. Touch **Stop intervals**.

Cancel a measurement that is in progress

Follow these steps to cancel any NIBP measurement that is in progress.



On the Home tab, touch

The monitor rapidly deflates the cuff, and the screen displays the NIBP cancellation message.



If intervals are turned on, the button changes to a timer (), which counts down to the next automatic measurement.



Configure NIBP alarms

Follow these steps to set alarm limits for systolic and diastolic measurements, and MAP calculation.

1. Verify that you are using the Monitor profile, which contains the Alarms tab.
2. Touch the **Alarms** tab.
3. Touch the **NIBP** tab.
4. Enter the desired upper and lower alarm limits for systolic and diastolic measurements, and MAP calculation using the up/down arrow keys or the keypad.
5. Touch the **Home** tab.

The new alarm settings display in the Alarm Limit control button.

Temperature

Temperature frame

From the temperature frame you can measure patient temperature.

Located in the lower right corner of the Home tab, the temperature frame contains data and features relevant to temperature measurement. The frame provides different features based on the profile you are using.

Temperature frame in Monitor profile



Temperature frame in Spot Check and Triage profiles



Temperature measurement display

In all profiles, the frame can display temperature in Celsius or Fahrenheit. You can configure the default view in Advanced settings.

Site selection

Remove the temperature probe and touch the **Temperature site control**  to toggle

between sites.

Pediatric axillary



Adult axillary



Oral



Note Monitors configured with the temperature module and the red rectal probe well and probe default to the rectal mode.

Rectal



Note The monitor displays the ear mode when it receives a temperature measurement from the ear thermometer.

Ear



Temperature buttons

The buttons on the right side of the frame enable you to do different tasks depending on the profile you are using. The availability of functions depends on which profile is selected.

Button name	Button image	Description
Temperature alarm		This button displays alarm limits and status. Touch the button to display the Alarms tab.

Button name	Button image	Description
Direct mode		Touch the button to enter Direct mode.

Configure temperature alarms

Follow these steps to set alarm limits for temperature measurement.

1. Verify that you are using the Monitor profile, which contains the Alarms tab.
2. Touch the **Alarms** tab.
3. Touch the **Temperature** tab.
4. Enter the desired upper and lower alarm limits for temperature using the up/down arrow keys or the keypad.
5. Touch the **Home** tab.

The new alarm settings display in the Alarm Limit control button.

SureTemp® Plus temperature module

The temperature module uses a thermistor thermometer design and a predictive algorithm to calculate patient temperatures in the Predictive mode.



WARNING Patient injury risk. Prior to taking a temperature, instruct the patient not to bite down on the probe as patient injury and damage to the probe may result.



WARNING Patient injury risk. Do not exceed the recommended temperature measurement durations in Direct mode. Continuous measurement durations of 3 minutes at the oral and rectal sites and 5 minutes at the axillary site are recommended for accurate measurement. Do not continuously measure beyond 10 minutes in any mode.



WARNING Probe covers are single-use only. Re-use of a probe cover may result in spread of bacteria and cross-contamination.



WARNING Patient injury risk. Use only Welch Allyn single-use disposable probe covers. Never take a temperature measurement without a single-use probe cover securely attached. Failure to use a probe cover can cause patient discomfort from a heated probe, patient cross-contamination, and inaccurate temperature readings.



WARNING Patient illness may result from improper use of oral and rectal temperature probes. Using the incorrect probe may also produce inaccurate measurements.

- Use only oral probes, identified by a blue ejection button at the top of the probe, to take oral and axillary temperatures.
- Use only rectal probes, identified by a red ejection button at the top of the probe, to take rectal temperatures.



WARNING Patient illness or cross-contamination may result from improper placement of oral and rectal temperature probes in the probe wells.

- Place only oral probes, identified by a blue ejection button at the top of the probe, in the blue probe wells.
- Place only rectal probes, identified by a red ejection button at the top of the probe, in the red probe wells.



WARNING Inaccurate measurement risk. Never take an axillary temperature through the patient's clothing. Carefully place the probe in the axilla, avoiding contact with other objects or material. Always verify direct contact between the probe cover and skin.



WARNING Patient injury risk. When taking rectal temperatures, insert the probe tip only 5/8 inch (approximately 1.5 cm) inside the rectum of adults and only 3/8 inch (approximately 1 cm) inside the rectum of children to avoid the risk of bowel perforation.



WARNING Never use a damaged temperature probe. The thermometer consists of high-quality precision parts and should be protected from severe impact or shock. Do not use the thermometer if you notice any signs of damage to the probe or monitor. If the thermometer probe is dropped or damaged, remove it from use and have it inspected by qualified service personnel.



Caution Inaccurate measurement risk. Patient activities such as strenuous exercise, ingesting hot or cold liquids, eating, chewing gum or mints, brushing teeth, or smoking may affect oral temperature measurements for up to 20 minutes.



Caution Inaccurate measurement risk. Always use new probe covers taken from the monitor's probe cover box holder to ensure accurate temperature measurements. Probe covers taken from other places or that haven't stabilized in temperature may result in inaccurate temperature measurements.

Temperature mode selection

The monitor with the temperature module takes a patient temperature in either Predictive (Normal) or Direct mode. The default setting is the Predictive mode.



WARNING Inaccurate measurement risk. To ensure optimal accuracy, always confirm that the correct mode and site are selected.



WARNING Patient injury risk. Do not exceed the recommended temperature measurement durations in Direct mode. Continuous measurement durations of 3 minutes at the oral and rectal sites and 5 minutes at the axillary site are recommended for accurate measurement. Do not continuously measure beyond 10 minutes in any mode.

Predictive mode

Is a one-time measurement that takes a temperature in approximately 6 to 15 seconds. Removing the probe from the probe well, loading a probe cover, and holding the probe tip in place at the measurement site initiates a Predictive mode measurement. The monitor sounds a tone to indicate the end of a predictive measurement.

Direct mode

Provides continual temperature measurements. For oral and rectal measurements, it is recommended to measure temperature until the temperature stabilizes or for 3 minutes. For axillary measurements, it is recommended to measure temperature until the temperature stabilizes or for 5 minutes. The monitor changes to Direct mode approximately 60 seconds after the probe is removed from the probe well.



Caution The monitor does not retain Direct mode temperatures in memory. Therefore, it is important to note the temperature before removing the thermometer probe from the measurement site and then manually record it in the patient record.

After 10 minutes of using the Direct mode, the monitor generates a technical alarm condition and clears the measurement.

Take a temperature in the Predictive mode



WARNING Inaccurate measurement risk. To ensure optimal accuracy, always confirm that the correct mode and site are selected.



WARNING Patient injury risk. Prior to taking a temperature, instruct the patient not to bite down on the probe as patient injury and damage to the probe may result.



Caution Probe covers are disposable, nonsterilized, and single-use. Probes are also nonsterilized. Do not autoclave probes and probe covers. Ensure that probe covers are disposed of according to facility requirements or local regulations.

1. Remove the temperature probe from the probe well.
The monitor sounds a tone as it enters the ready state.
2. Insert the probe into a new probe cover and press the probe handle down firmly.
3. Touch the **Temperature site control**  to choose from these measurement sites: oral, pediatric axillary, or adult axillary.
4. Hold the probe tip in place at the measurement site.

For oral temperatures, place the probe tip under the patient's tongue on either side of the mouth to reach the sublingual pocket and ask the patient to close his/her lips.

Note Do not hand the probe to patients to place in their mouth.

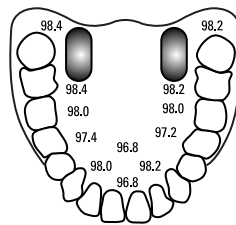

For axillary temperatures, lift the patient's arm so that the entire axilla is easily seen and place the probe tip as high as possible in the mid-axilla. Verify that axillary tissue completely surrounds the probe tip and place the arm snugly at the patient's side.

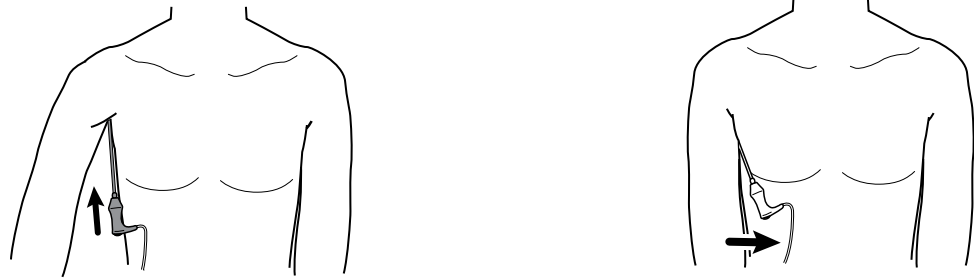

While the measurement is taking place, the temperature frame displays the process indicator.



- The monitor sounds a tone when the final temperature is reached (in approximately 6 to 15 seconds). The temperature frame continues to display the temperature in degrees Fahrenheit and degrees Celsius even after the probe is returned to the probe well.



Note

To switch to the Direct mode, touch  after you acquire the Predictive mode measurement. The temperature frame (in the lower-left corner) changes to "MODE: Direct..." as it switches to the Direct mode.

The monitor sounds a tone at the start of a Direct mode measurement.

- Remove the probe after the temperature measurement is complete and firmly press the eject button on the top of the probe to release the probe cover.



WARNING Patient injury risk. Do not exceed the recommended temperature measurement durations in Direct mode. Continuous measurement durations of 3 minutes at the oral and rectal sites and 5 minutes at the axillary site are recommended for accurate measurement. Do not continuously measure beyond 10 minutes in any mode.

Ensure that probe covers are disposed of according to facility requirements or local regulations.

- Return the probe to the probe well.
- Wash your hands to reduce the risk of cross-contamination.

Take a temperature in the Direct mode

Direct mode displays the temperature of the probe as long as the probe tip remains in place at the measurement site and remains within the operating patient temperature range. The patient's temperature will reach final equilibrium in approximately 3 minutes at the oral and rectal measurement sites and approximately 5 minutes at the axillary site.

The monitor enters Direct mode by the following methods.

- After you complete a Predictive mode measurement, touch  to switch from Predictive to Direct mode. The temperature frame (in the lower-left corner) changes to "MODE: Direct..." as it switches to the Direct mode.
- Remove the probe from the probe well, load a probe cover, select a temperature site, and expose the probe to ambient air for more than 60 seconds to switch the monitor to Direct mode. The temperature frame changes to "MODE: Direct...".
- If you have a patient whose body temperature is below the normal temperature range and you follow the previous step, the probe sensor identifies this condition and turns off the probe preheater in order to accommodate the lower body temperature measurement.



WARNING Patient injury risk. Do not exceed the recommended temperature measurement durations in Direct mode. Continuous measurement durations of 3 minutes at the oral and rectal sites and 5 minutes at the axillary site are recommended for accurate measurement. Do not continuously measure beyond 10 minutes in any mode.



WARNING Inaccurate measurement risk. To ensure optimal accuracy, always confirm that the correct mode and site are selected.



WARNING Patient injury risk. Prior to taking a temperature, instruct the patient not to bite down on the probe as patient injury and damage to the probe may result.



Caution Probe covers are disposable, nonsterilized, and single-use. Probes are also nonsterilized. Do not autoclave probes and probe covers. Ensure that probe covers are disposed of according to facility requirements or local regulations.

1. Remove the temperature probe from the probe well.
The monitor sounds a tone as it enters the ready state.
2. Insert the probe into a new probe cover and press the probe handle down firmly.
3. Touch the **Temperature site control**  to choose from these measurement sites: oral, pediatric axillary, or adult axillary.

The temperature frame changes to Direct mode approximately 60 seconds after the probe is removed from the probe well.

The monitor sounds a tone to indicate the start of a Direct mode measurement.

4. Hold the probe tip in place at the oral or rectal measurement site for a total of 3 minutes and for 5 minutes at the axillary site.
5. While the measurements are taking place, the temperature frame displays the patient's continuous temperature measurements in degrees Fahrenheit and degrees Celsius.



Note The monitor does not retain Direct mode temperatures in memory. Therefore, it is important to note the temperature before removing the probe from the measurement site and then manually record it in the patient record.

6. Remove the probe after the temperature measurement is complete and firmly press the eject button on the top of the probe to release the probe cover.
7. Return the probe to the probe well to continue taking temperatures in the Predictive mode.
8. Wash your hands to reduce the risk of cross-contamination.

Take a temperature at the rectal site



WARNING Patient injury risk. When taking rectal temperatures, insert the probe tip only 5/8 inch (approximately 1.5 cm) inside the rectum of adults and only 3/8 inch (approximately 1 cm) inside the rectum of children to avoid the risk of bowel perforation.



WARNING Cross-contamination or nosocomial infection risk. Thorough hand-washing greatly reduces the risk of cross-contamination and nosocomial infection.



WARNING Patient injury risk. Do not exceed the recommended temperature measurement durations in Direct mode. Continuous measurement durations of 3 minutes at the oral and rectal sites and 5 minutes at the axillary site are recommended for accurate measurement. Do not continuously measure beyond 10 minutes in any mode.



WARNING Inaccurate measurement risk. To ensure optimal accuracy, always confirm that the correct mode and site are selected.



Caution Probe covers are disposable, nonsterilized, and single-use. Probes are also nonsterilized. Do not autoclave probes and probe covers. Ensure that probe covers are disposed of according to facility requirements or local regulations.

1. Remove the rectal temperature probe from the rectal probe well.

The monitor sounds a tone as it enters the ready state. The Temperature Site Control defaults to the rectal site.



2. Insert the rectal probe into a new probe cover and press the probe handle down firmly.
3. Separate the patient's buttocks with one hand. Use the other hand to gently insert the probe tip only 5/8 inch (1.5 cm) inside the rectum of adults and only 3/8 inch (approximately 1 cm) inside the rectum of children. The use of a lubricant is optional.
4. Insert the probe so that the tip is in contact with tissue. Continue to separate the buttocks and hold the probe in place throughout the measurement process. While the measurement is taking place, the temperature frame displays the process indicator.



- The monitor sounds a tone when the final temperature is reached (in approximately 10 to 13 seconds). The temperature frame continues to display the temperature in degrees Fahrenheit and degrees Celsius even after the probe is returned to the probe well.

**Note**

To switch to the Direct mode, touch  after the Predictive

mode measurement is acquired. The temperature frame (in the lower-left corner) changes to "MODE: Direct..." as it switches to the Direct mode. The monitor sounds a tone to indicate the start of a Direct measurement. Once you are in the Direct mode, continue to separate the buttocks and hold the probe in place throughout the measurement process.

Note

The monitor does not retain Direct mode temperatures in memory. Therefore, it is important to note the temperature before removing the probe from the measurement site and then manually record it in the patient record.

- Remove the probe after the temperature measurement is complete and firmly press the eject button on the top of the probe to release the probe cover.
- Return the probe to the probe well.
- Wash your hands to reduce the risk of cross-contamination.

Braun ThermoScan® PRO 4000 thermometer and accessory dock

The thermometer and accessory dock enable you to transfer an ear temperature measurement to the monitor. The dock also charges the thermometer battery.

Read the thermometer manufacturer's directions for use before attempting to configure, use, troubleshoot, or maintain the thermometer.



WARNING Liquids can damage electronics inside the thermometer. Prevent liquids from spilling on the thermometer. If liquids are spilled on the thermometer, dry off the thermometer with a clean cloth. Check for proper operation and accuracy. If liquids possibly entered the thermometer, remove the thermometer from use until it has been properly dried, inspected, and tested by qualified service personnel.



Caution Probe covers are disposable, nonsterilized, and single-use. The thermometer is also nonsterilized. Do not autoclave the thermometer and probe covers. Ensure that probe covers are disposed of according to facility requirements or local regulations.



Caution The thermometer has no user-serviceable parts. If service is required, call your nearest Welch Allyn Customer Service or Technical Support facility.



Caution Store the thermometer and probe covers in a dry location, free from dust and contamination and away from direct sunlight. Keep the ambient temperature at the storage location fairly constant and within the range of 50°F to 104°F (10°C to 40°C).

Take a temperature at the ear site



WARNING Probe covers are single-use only. Re-use of a probe cover may result in spread of bacteria and cross-contamination.



WARNING Inaccurate measurement risk. Use only Braun ThermoScan probe covers with this thermometer.



WARNING Inaccurate measurement risk. Frequently inspect the probe window and keep it clean, dry, and undamaged. Fingerprints, cerumen, dust, and other contaminants reduce the transparency of the window and result in lower temperature measurements. To protect the window, always keep the thermometer in the accessory dock when the thermometer is not in use.



Caution Inaccurate measurement risk. Before taking a temperature measurement, make sure that the ear is free from obstructions and excess cerumen build-up.



Caution Inaccurate measurement risk. The following factors can affect ear temperature measurements for up to 20 minutes:

- The patient was lying on his or her ear.
- The patient's ear was covered.
- The patient was exposed to very hot or very cold temperatures.
- The patient was swimming or bathing.
- The patient was wearing a hearing aid or an ear plug.



Caution Inaccurate measurement risk. If ear drops or other ear medications have been placed in one ear canal, take the temperature in the untreated ear.

Note A temperature measurement taken in the right ear might differ from a measurement taken in the left ear. Therefore, always take the temperature in the same ear.

Note When the monitor receives an ear temperature measurement, it displays the measurement on the Home tab. If the Home tab already contains a temperature measurement, the new measurement overwrites it.

To take a measurement and transfer it to the monitor:

1. Make sure that the monitor is powered on.
2. Remove the ear thermometer from the accessory dock.
3. Locate the probe cover box in the accessory dock.
4. Firmly push the probe tip into the probe cover box.

When the probe cover is in place, the thermometer turns on automatically.

5. Wait for the ready beep and three dashes to appear on the thermometer display.
6. Fit the probe snugly into the ear canal and then push and release the **Start** button.
 - If the probe is positioned correctly in the ear canal the ExacTemp light flashes. When the thermometer detects an accurate measurement, the ExacTemp light is continuously on, a long beep signals the end of the measurement, and the display shows the result.

- If the probe is positioned incorrectly in the ear canal or is moved during the measuring process, the ExacTemp light goes out, a sequence of short beeps sounds, and the error message POS (position error) appears.
7. When you are finished taking the temperature, press the ejector button to eject the used probe cover.
 8. Return the thermometer to the accessory dock.

The LED on the dock flashes while the measurement is being transferred.

After the transfer is complete, the temperature and the temperature scale appear on the Home tab according to the monitor settings.

Note Only the latest measurement is transferred to the monitor.

Note Measurements that have already been transferred to the monitor cannot be transferred again.

For more information about thermometer functionality, refer to the thermometer manufacturer's directions for use.

Change the temperature scale on the ear thermometer

To switch from Celsius to Fahrenheit, refer to the thermometer manufacturer's directions for use.

Charge the ear thermometer battery

To charge the battery pack:

- Place the thermometer in the accessory dock.
- Make sure that the monitor is connected to AC power.
- Make sure that the monitor is powered on.

The LED on the dock indicates the charging status of the battery pack:

- Orange: The battery pack is charging.
- Green: The battery pack is charged.
- Not illuminated: The battery pack is not charging.

Note The battery pack continues to charge while the monitor is in Display power saving mode.

Note It is strongly recommended that you use only the Welch Allyn rechargeable battery pack in the thermometer because the dock cannot charge other batteries.

SpO2

SpO2 and pulse rate monitoring continuously measures saturation level of oxygen in hemoglobin as well as the pulse rate in a patient through a pulse oximeter.

SpO2 frame

The SpO2 frame displays data and controls used in pulse oximetry measurements.

The frame provides a numeric view and a waveform view of SpO2 data. You can toggle between views by touching the left side of the frame.

SpO2 numeric view

The numeric view indicates the SpO2 saturation percentage and the pulse amplitude. Features of this view differ based on the type of sensor enabled and the profile selected.

Nellcor sensor



Monitor profile

Spot Check and Triage profiles

Masimo sensor

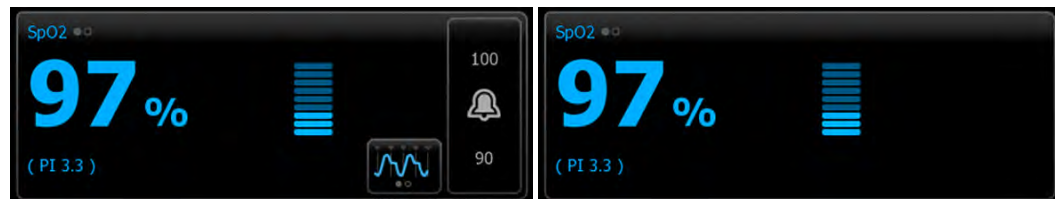

Monitor profile

Spot Check and Triage profiles

Pulse amplitude

The pulse amplitude bar indicates the pulse beat and shows the relative pulse strength. More bars illuminate as the detected pulse gets stronger.



Response Mode Control

The Response Mode Control allows you to set the SpO2 measurement time to either Normal or Fast.



Perfusion index

Perfusion Index (PI) is an SpO2 feature available only with Masimo-equipped monitors.

PI is a relative reading of pulse strength at the monitoring site. PI is a numerical value that indicates the strength of the IR (infrared) signal returning from the monitoring site. PI display ranges from .02 percent (very weak pulse strength) to 20 percent (very strong pulse strength). PI is

a relative number and varies between monitoring sites and from patient to patient, as physiological conditions vary.



During sensor placement, the PI can be used to evaluate the appropriateness of an application site, looking for the site with the highest PI number. Placing the sensor at the site with the strongest pulse amplitude (highest PI number) improves performance during motion. Monitor the trend of the PI for changes in physiological conditions.

SatSeconds™ alarm management

The SatSeconds feature is an SpO2 alarm management system available only with monitors that are equipped with Nellcor OxiMax Technology.

The SatSeconds feature is the product of the time and magnitude that a patient falls outside of the SpO2 alarm limits. For example, three points below the alarm limit for 10 seconds equals 30 SatSeconds. An alarm is triggered only when a desaturation event reaches the SatSeconds limit. The SatSeconds feature is clinician controlled and can be set to 0, 10, 25, 50, or 100 SatSeconds. If a desaturation event resolves on its own within the preset time, the clock will automatically reset and the monitor will not alarm.



Note The SatSeconds feature has a built-in safety protocol that sounds an alarm whenever three SpO2 violations of any amount or duration occur within a 1-minute period.

SpO2 waveform view

The waveform view shows the real-time SpO2 plethysmograph waveform. You can select the waveform sweep speed in Advanced settings.

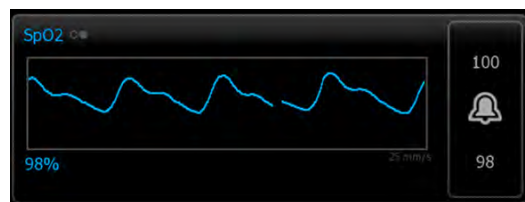

Measure SpO2 and pulse rate



WARNING Inaccurate measurement risk. Use only Masimo Rainbow SET sensors and accessories on Masimo-equipped monitors.



WARNING Inaccurate measurement risk. Use only Nellcor sensors and accessories on Nellcor-equipped monitors.



WARNING The pulsations from intra-aortic balloon support can increase the pulse rate displayed on the monitor. Verify the patient's pulse rate against the ECG heart rate.



WARNING Patient injury risk. Do not attempt to reprocess, recondition, or recycle any sensors or patient cables. Doing so might damage electrical components.



WARNING Pulse rate measurement might not detect certain arrhythmias because it is based on the optical detection of a peripheral flow pulse. Do not use the pulse oximeter as a replacement or substitute for ECG-based arrhythmia analysis.



WARNING Use the pulse co-oximeter as an early warning device. As you observe a trend toward patient hypoxemia, use laboratory instruments to analyze blood samples to better understand the patient's condition.



WARNING The accuracy of SpO₂ measurements can be affected by any of the following:

- elevated levels of total bilirubin
- elevated levels of Methemoglobin (MetHb)
- elevated levels of Carboxyhemoglobin (COHb)
- hemoglobin synthesis disorders
- low perfusion at the monitored site
- the presence of concentrations of some intravascular dyes, sufficient to change the patient's usual arterial pigmentation
- patient movement
- patient conditions such as shivering and smoke inhalation
- motion artifact
- painted nails
- poor oxygen perfusion
- hypotension or hypertension
- severe vasoconstriction
- shock or cardiac arrest
- venous pulsations or sudden and significant changes in pulse rate
- proximity to an MRI environment
- moisture in the sensor
- excessive ambient light, especially fluorescent
- the use of the wrong sensor
- a sensor applied too tightly

1. Verify that the sensor cable is connected to the monitor.



WARNING Patient injury risk. The sensor and extension cable are intended only for connection to pulse co-oximetry equipment. Do not attempt to connect these cables to a PC or any similar device. Always follow the sensor manufacturer's directions for care and use of the sensor.

2. Clean the application site. Remove anything, such as nail polish, that could interfere with sensor operation.

Note Do not use disposable sensors on patients who have allergic reactions to the adhesive.

3. Attach the sensor to the patient according to the manufacturer's directions for use, observing all warnings and cautions.

Note If a sterile sensor is required, select a sensor that has been validated for sterilization, and follow the sensor manufacturer's directions for sterilizing the sensor.

Place the sensor and the NIBP cuff on different limbs to reduce unnecessary alarms when you monitor these parameters at the same time.

Note A range of sensors is available for different patient sizes and measurement sites. Consult the sensor manufacturer's instructions for selecting the correct sensor.

4. Confirm that the monitor displays SpO2 and pulse rate data within 15 seconds of connection to the patient.



WARNING Patient injury risk. Incorrect sensor application or excessive duration of sensor use can cause tissue damage. Inspect the sensor site periodically as directed in the sensor manufacturer's instructions.

While SpO2 is being measured, the displayed pulse rate is derived from the sensor. If SpO2 is not available, the pulse rate is derived from NIBP.

Detaching the sensor during a measurement in Monitor mode triggers an alarm.

If SpO2 is being measured continuously on a patient for an extended period, change the sensor location at least every three hours or as indicated by the sensor manufacturer's instructions.

Configure SpO2 alarms

Follow these steps to set alarm limits for SpO2 measurements.

1. Verify that you are using the Monitor profile, which contains the Alarms tab.
2. Touch the **Alarms** tab.
3. Touch the **SpO2** tab.
4. Enter the desired upper and lower alarms limits for SpO2 using the up/down arrow keys or the keypad.
5. Touch the **Home** tab.

The new alarm settings display in the Alarm Limit control button.

Set SatSeconds limits

1. Touch the **Alarm limit control** of the SpO2 frame
2. Touch the **Alarms** tab.



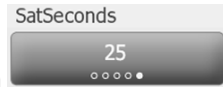

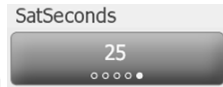
3. Touch  to select a SatSeconds setting.
4. Touch **Home** to save your settings and return to the Home tab.

Set Response Mode

To set the Response Mode from the Home tab, the monitor must be in the Monitor profile.



Touch  in the SpO2 frame.

The SpO2 frame displays **MODE: Fast** when Fast mode is selected.

SpHb

Monitors configured with Masimo total hemoglobin can measure hemoglobin (SpHb), SpO2, and pulse rate. SpHb monitoring continuously measures blood constituents and anemic status in a patient through a noninvasive SpHb pulse co-oximeter.

SpHb frame

The SpHb frame displays data and controls used in total hemoglobin measurements.

Note SpHb is available only in the Monitor profile.

In this frame, one of two labels appears:

- **SpHbv** indicates the venous calibrated reference for total hemoglobin measurement.
- **SpHb** indicates the arterial calibrated reference for total hemoglobin measurement.

You can specify the reference source in Advanced settings.

The frame provides a numeric view and a graphical trend view of total hemoglobin data. You can toggle between views by touching the left side of the frame.

SpHb numeric view

The numeric view indicates the total hemoglobin level in either grams per deciliter (g/dL) or millimoles per liter (mmol/L). You can select the unit of measure in Advanced settings.

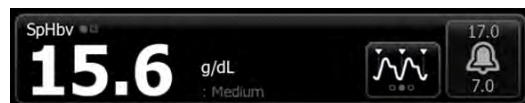

Averaging

The averaging button enables you to select the moving window of time used by the parameter to calculate the SpHb value and update the display: short (approximately 1 minute), medium (approximately 3 minutes), or long (approximately 6 minutes).



SpHb graphical trend view

The graphical trend view presents a trend of the real-time measurements over a user-selected period. In Advanced settings, you can select the period displayed.



The graph shows total hemoglobin level on the y-axis and time on the x-axis (oldest measurements on the left to newest measurements on the right). The entire graph updates every 10 seconds.

To the right of the graph, the frame displays the current measurement in numeric format.

Measure SpHb



WARNING Inaccurate measurement risk. Use only Masimo Rainbow SET sensors and accessories on Masimo-equipped monitors.



WARNING The pulsations from intra-aortic balloon support can increase the pulse rate displayed on the monitor. Verify the patient's pulse rate against the ECG heart rate.



WARNING Patient injury risk. Do not attempt to reprocess, recondition, or recycle any sensors or patient cables. Doing so might damage electrical components.



WARNING Pulse rate measurement might not detect certain arrhythmias because it is based on the optical detection of a peripheral flow pulse. Do not use the pulse oximeter as a replacement or substitute for ECG-based arrhythmia analysis.



WARNING Use the pulse co-oximeter as an early warning device. As you observe a trend toward patient hypoxemia, use laboratory instruments to analyze blood samples to better understand the patient's condition.



WARNING The accuracy of SpHb measurements can be affected by any of the following:

- elevated levels of total bilirubin
- elevated levels of Methemoglobin (MetHb)
- elevated levels of Carboxyhemoglobin (COHb)
- hemoglobin synthesis disorders
- low perfusion at the monitored site
- the presence of concentrations of some intravascular dyes, sufficient to change the patient's usual arterial pigmentation
- patient movement
- patient conditions such as shivering and smoke inhalation
- motion artifact
- painted nails
- poor oxygen perfusion
- hypotension or hypertension
- severe vasoconstriction
- shock or cardiac arrest
- venous pulsations or sudden and significant changes in pulse rate
- proximity to an MRI environment
- moisture in the sensor
- excessive ambient light, especially fluorescent
- the use of the wrong sensor
- a sensor applied too tightly

1. Verify that the sensor cable is connected to the monitor.



WARNING Patient injury risk. The sensor and extension cable are intended only for connection to pulse co-oximetry equipment. Do not attempt to connect these cables to a PC or any similar device. Always follow the sensor manufacturer's directions for care and use of the sensor.

2. Verify that you are using the Monitor profile.
3. Clean the application site. Remove anything, such as nail polish, that could interfere with sensor operation.

Note Do not use disposable sensors on patients who have allergic reactions to the adhesive.

4. Attach the sensor to the patient according to the manufacturer's directions for use, observing all warnings and cautions.

Note If a sterile sensor is required, select a sensor that has been validated for sterilization, and follow the sensor manufacturer's directions for sterilizing the sensor.

Place the sensor and the NIBP cuff on different limbs to reduce unnecessary alarms when you monitor these parameters at the same time.

Note A range of sensors is available for different patient sizes and measurement sites. Consult the sensor manufacturer's instructions for selecting the correct sensor.

5. Confirm that the monitor displays SpHb or SpHbv data within 160 seconds of connection to the patient.



WARNING Patient injury risk. Incorrect sensor application or excessive duration of sensor use can cause tissue damage. Inspect the sensor site periodically as directed in the sensor manufacturer's instructions.

While SpHb is being measured, the displayed SpO2 and pulse rate are derived from the same sensor. If SpO2 is not available, the pulse rate is derived from NIBP.

Detaching the sensor during a measurement triggers an alarm.

If SpHb is being measured continuously on a patient for an extended period, change the sensor location at least every three hours or as indicated by the sensor manufacturer's instructions.

Configure SpHb alarms

Follow these steps to set alarm limits for SpHb measurements.

1. Verify that you are using the Monitor profile, which contains the Alarms tab.
2. Touch the **Alarms** tab.
3. Touch the **SpHb** tab.
4. Enter the desired upper and lower alarm limits for SpHb using the up/down arrow keys or the keypad.
5. Touch the **Home** tab.

The new alarm settings appear in the Alarm Limit control button.

Set SpHb averaging mode



Touch  in the SpHb frame.

The SpHb frame displays the current mode.

Pulse rate frame

The pulse rate frame, located in the upper right of the Home tab, displays data, information, and controls used in reading pulse rates.

Typically, the displayed pulse rate is derived from the SpO2 sensor. If SpO2 is not available, the pulse rate is derived from NIBP.



WARNING Inaccurate measurement risk. Pulse rate measurements generated through the blood pressure cuff or through SpO2 are subject to artifact and might not be as accurate as heart rate measurements generated through ECG or through manual palpation.

Note You can specify pulse tone volume in the Pulse rate tab (located in the Alarms tab).

Monitor profile

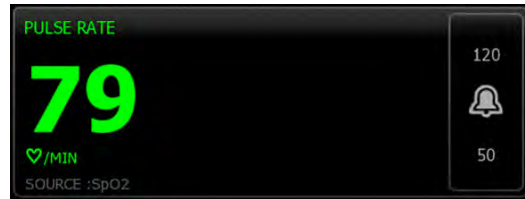

Spot Check and Triage profiles

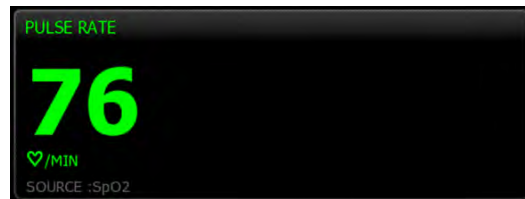

Configure pulse rate alarms

Follow these steps to set alarm limits for pulse rate.

1. Verify that you are using the Monitor profile, which contains the Alarms tab.
2. Touch the **Alarms** tab.
3. Touch the **Pulse rate** tab.
4. Enter the desired upper and lower alarm limits for pulse rate using the up/down arrow keys or the keypad.
5. Touch the **Home** tab.

The new alarm settings display in the Alarm Limit control button.

Manual parameters frame

The Manual parameters frame, located in the lower right of the Home tab, supports manual entry of parameters and displays measurements taken by some accessories.

Note Manual parameters are not available in the Triage profile.

Note Body mass index (BMI) is only available with an attached weight scale that calculates BMI.

Note When a measurement is transferred from an attached weight scale to the monitor, the measurement displayed on the monitor is within one decimal place (0.1) of the measurement displayed by the weight scale.

Note You cannot manually enter temperature on a monitor configured with a SureTemp Plus temperature module.

Enter manual parameters

Note The Manual parameters frame enables you to enter measurements taken manually and displays measurements taken by some accessories. You can select and configure the parameters in Advanced settings. Only four parameters appear in the Manual parameters frame.



Caution Weight scales attached to this monitor must be running on battery power (battery type is specified in the weight scale manufacturer's directions for use). Do not use the weight scale's external power supply.

1. From the Home tab, touch anywhere within the Manual parameters frame.

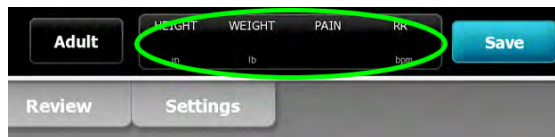

The Manual tab appears. Two examples appear below.

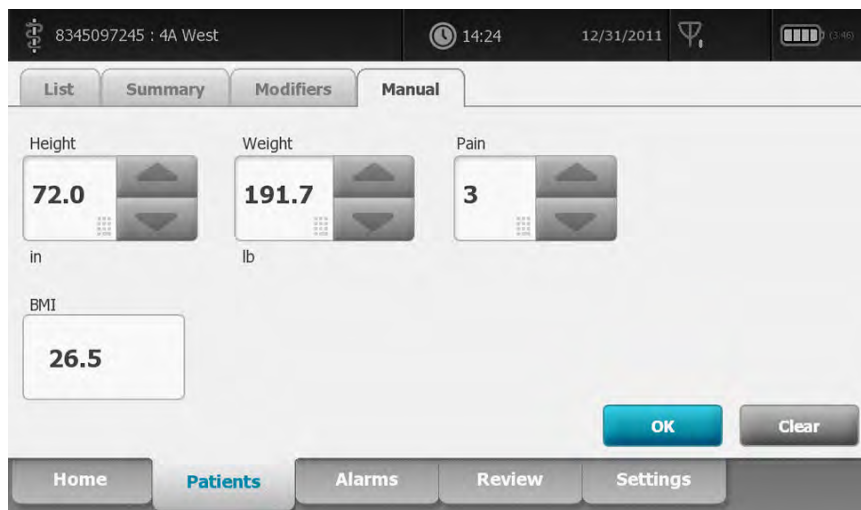
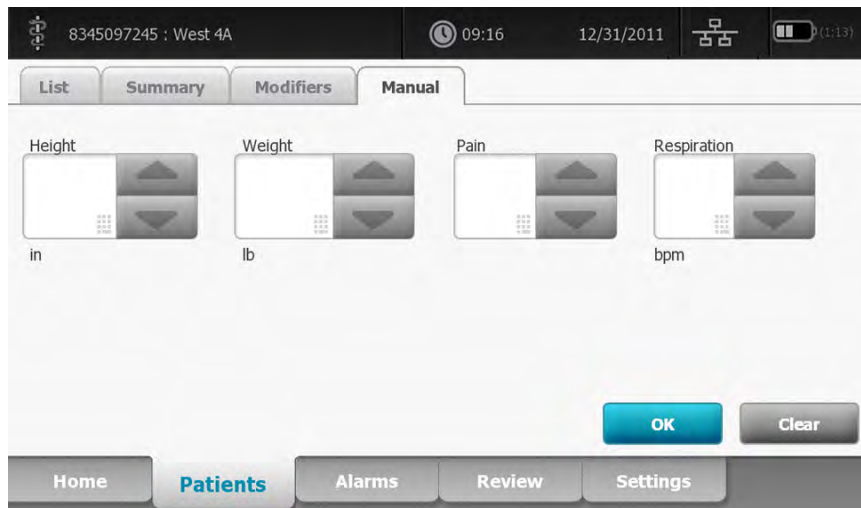

2. Touch the up/down arrow keys or the keypad to manually adjust height, weight, pain level, temperature, respiration rate, or other parameters.

Note If an approved, battery-powered weight scale is attached to the monitor, measurements from the weight scale populate fields in the Manual tab. You can adjust weight and height measurements on this tab, but if you do, the read-only BMI field will clear.

Note Ensure that the current patient ID is correct before saving.

3. Touch  to confirm settings and return to the Home tab.

Note During intervals, each automatic and manual save of patient measurements clears all measurements from the Manual parameters frame.

Maintenance and service

Perform periodic checks

Welch Allyn recommends that each facility conduct periodic checks of each monitor.

1. Check the following at least daily:
 - Audio (speaker and piezo beeper tones), especially at startup
 - Fan, especially at startup
 - Touchscreen alignment
 - Date
 - Time
2. Visually inspect the following at least weekly:
 - the monitor for any damage or contamination
 - all cables, cords, and connector ends for damage or contamination
 - all mechanical parts, including covers, for integrity
 - all safety-related labeling for legibility and adhesion to the monitor
 - all accessories (cuffs, tubing, probes, sensors) for wear or damage
 - documentation for current revision of the monitor
3. Visually inspect the following at least monthly:
 - Mobile stand wheels for wear and faulty operation
 - Mounting screws on wall or cart for looseness and wear

Update settings, replace items, or call for service as necessary based on results of visual inspection. Do not use the monitor if you see any signs of damage. Qualified service personnel must check any monitor that is damaged for proper operation before putting the monitor back into use.

Replace the printer paper

The printer is located on the top of the monitor. Follow these steps to replace the roll of printer paper:

1. Grasp the two tabs and pull up to open the printer door.
2. Remove the empty core.



WARNING Hot surface. Do not touch the printer mechanism.

3. Insert a new roll of paper.

Note

The paper roll must be installed as illustrated. If the paper roll is not installed correctly, the printer will not print properly.

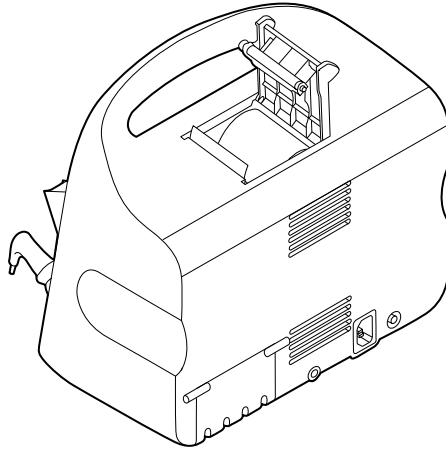

4. Advance the end of the roll past the roller so that it extends past the printer door, as shown.

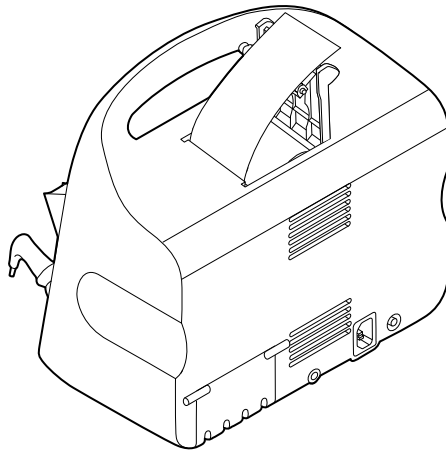

5. With one hand, pull lightly on the paper to take up any slack. With the other hand, close the printer door by pushing it down and into place until it clicks.

Be certain that the paper does not catch in the printer door.

Change the battery

Before removing the battery, shut down the monitor.

1. Turn the monitor upside down to access the battery cover.
2. Locate the battery cover, indicated by .
3. Insert a coin into the slot and push to open. Choose a coin that fits comfortably in the slot.

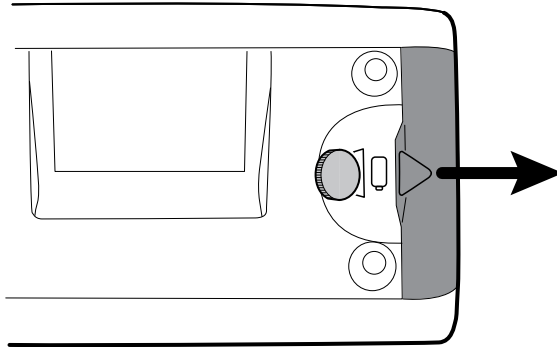

4. Pull the battery out by pulling the battery label, which is visible when you open the battery cover.

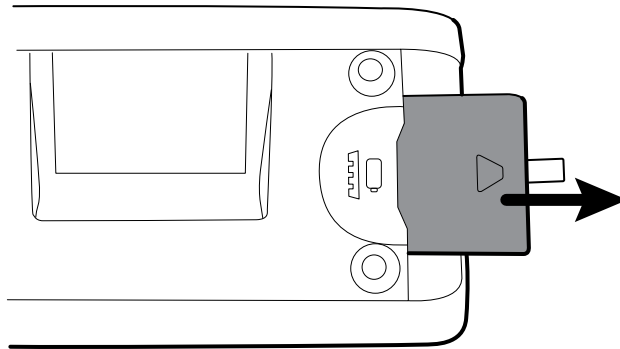

5. Slide in the new battery. Ensure that you insert the new battery in the same orientation as the old battery.

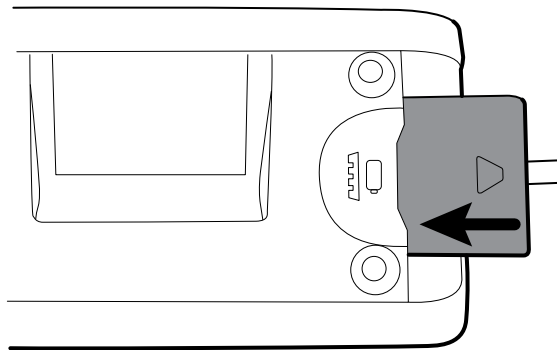

6. Replace the battery cover by positioning the end below  and then pressing firmly on the opposite end.

Note New batteries are approximately 30 percent charged. Therefore, connect the battery to AC power immediately after inserting a new a battery.



WARNING Risk of fire, explosion, and burns. Do not short-circuit, crush, incinerate, or disassemble the battery pack. Never dispose of batteries in refuse containers. Always recycle batteries according to local regulations.

Clean the monitor



WARNING Electric shock hazard. Before cleaning the monitor, disconnect the AC power cord from the power outlet and the monitor.



WARNING Electric shock hazard. DO NOT autoclave the monitor or accessories. The monitor and the accessories are not heat-resistant.



WARNING Liquids can damage electronics inside the monitor. Prevent liquids from spilling on the monitor.

If liquids are spilled on the monitor:

1. Power down the monitor.
2. Disconnect the power plug.
3. Remove battery pack from the monitor.
4. Dry off excess liquid from the monitor.

Note If liquids possibly entered the monitor, remove the monitor from use until it has been properly dried, inspected, and tested by qualified service personnel.

5. Reinstall battery pack.
6. Power on the monitor and verify monitor functions normally before using it.

If liquids enter the printer housing:

1. Power down the monitor.
2. Disconnect the power plug.
3. Remove battery pack from the monitor.
4. Remove and discard the paper roll.
5. Clean and dry the inside of the printer housing.

Note The printer housing has a drain tube that directs liquids down and out the bottom of the device. If liquids possibly entered other openings in the monitor, remove the monitor from service until it has been properly dried, inspected, and tested by qualified service personnel.

6. Install a new roll of paper.
7. Power on the monitor and verify that the monitor functions normally before using it.

Clean on a routine basis according to your facility's protocols and standards or local regulations. If the monitor is on, lock the display and disconnect the AC power cord.

The following agents are compatible with the monitor:

- CaviWipes™
- Sani-Cloth® Plus
- 70 percent isopropyl alcohol
- 10 percent chlorine bleach solution

Note Disinfect according to your facility's protocols and standards or local regulations.

CaviWipes or Sani-Cloth Plus

1. Using CaviWipes or Sani-Cloth Plus, wipe the surface of the monitor to remove all debris.
2. Allow the monitor surface to dry for a minimum of 10 minutes before using the monitor.

70 percent isopropyl alcohol

Wipe the monitor with a clean cloth slightly dampened with 70 percent isopropyl alcohol.

10 percent chlorine bleach solution

1. Wipe the monitor with a clean cloth slightly dampened with a 10 percent bleach and water solution. Follow the cleaning agent manufacturer's guidelines.
2. Rinse with a clean cloth slightly dampened with water that meets EP and USP quality standards.
3. Allow the monitor surface to dry for a minimum of 10 minutes before using the monitor.

Clean the accessories

1. Wipe the NIBP hose and any reusable cuffs with a damp cloth moistened in a mild detergent solution.
2. Wipe the temperature probe with a cloth dampened with alcohol, warm water, or an appropriately diluted, nonstaining disinfectant solution.
3. Clean the pulse oximetry sensors with a cloth dampened with 70 percent isopropyl alcohol or 10 percent chlorine bleach solution.
4. Clean the ear thermometer according to the manufacturer's directions for use.
5. Clean the ear thermometer dock with the same cleaning agents used on the monitor.



Caution Never immerse any monitor accessories.

Clean the stand

The same cleaning agents used on the monitor can be used on the stand and accessory cable management system. Clean on a routine basis according to your facility's protocols and standards, or local regulations.

Note Disinfect according to your facility's protocols and standards, or local regulations.

Specifications

Physical specifications

Protection classifications, all monitor configurations

Characteristic	Specification
Electrical rating	100 – 240 V AC, 50 – 60 Hz, 1.5 – 0.8 A
Duty cycle	Continuous operation
Type of protection against electric shock	Class I equipment (protectively earthed) with double insulation
Degree of protection against electric shock, for parts applied to patients	Type BF defibrillator proof IEC EN 60601-1, 2nd Edition
Recovery time following defibrillator discharge	Less than or equal to 10 seconds
Flammable anesthetics	 WARNING Not suitable for use with flammable anesthetics.
Degree of protection provided by the enclosure with respect to harmful ingress of liquids	IPX0 Non-protected according to EN/IEC 60529; Pulse oximeter equipment complies with ISO 9919 Cl. 44.6 Ingress of liquids tests and EN/IEC 60601-1, 60601-2-30, 60601-2-49 Cl. 44.3 Spillage tests
Height	10 in. (25.4 cm)
Width	11 in. (29.2 cm)
Depth	6 in. (15.7 cm)
Weight (including battery)	9.5 lb. (4.3 kg)
Graphical display resolution	
Display area	8 in. (H) x 4 in. (V) (19.5 [H] cm x 11.3 [V] cm)
Pixels	1024 (H) x 600 (V)

Protection classifications, all monitor configurations

Pixel arrangement	RGB (red, green, blue)
-------------------	------------------------

Color depth	16 bits per pixel
-------------	-------------------

Speaker volume

Output sound pressure	67 dB at 1.0 meter
-----------------------	--------------------

Alarm and pulse tones	per IEC 60601-1-8
------------------------------	-------------------

Pulse frequency (f_0)	150 – 1000 Hz
---------------------------	---------------

Number of harmonic components in the range 300 Hz to 4000 Hz	minimum of 4
--	--------------

Effective pulse duration (t_d)	high priority: 75 – 200 ms medium and low priority: 125 – 250 ms
------------------------------------	---

Rise time (t_r)	10 – 20% of t_d
---------------------	-------------------

Fall time ^a (t_f)	$t_f \leq t_s - t_r$
----------------------------------	----------------------

Note The relative sound pressure level of the harmonic components should be within 15 dB above or below the amplitude at the pulse frequency.

^a Prevents overlap of pulses.

Battery specifications	6 cell	9 cell
Rating	11.1 V 3.80Ah (42Wh)	10.8 V 6.75Ah (73Wh)
Composition	Lithium-ion	Lithium-ion
Charge time to 80 percent capacity	2hr 7m	2hr 25m
Charge time to 100 percent capacity	3hr	4hr
Patient exams per charge ¹	26	47
Age to 70 percent capacity ²	300	300

¹A patient exam includes NIBP, Temperature, and SpO2 measurements at the rate of one patient every 10 minutes with a 2-minute display time out setting and a new battery.

²After this many full charge and discharge cycles, the battery has aged to where its total capacity has been reduced to 70 percent of its rating.

Nurse Call connection specifications

Nurse Call	25 V AC or 60 V DC maximum at 1A maximum
------------	--

NIBP specifications

Cuff pressure range	Meets or exceeds ANSI/AAMI SP10:2002 standards for cuff pressure range
Systolic range	Adult: 30 to 260 mmHg (StepBP, SureBP) Pediatric: 30 to 260 mmHg (StepBP, SureBP) Neonate: 20 to 120 mmHg (StepBP)
Diastolic range	Adult: 20 to 220 mmHg (StepBP, SureBP) Pediatric: 20 to 220 mmHg (StepBP, SureBP) Neonate: 10 to 110 mmHg (StepBP)
Cuff Inflation Target	Adult: 160 mmHg (StepBP) Pediatric: 120 mmHg (StepBP) Neonate: 90 mmHg (StepBP)
Maximum Target Pressure	Adult: 280 mmHg (StepBP, SureBP) Pediatric: 280 mmHg (StepBP, SureBP) Neonate: 130 mmHg (StepBP)
Blood pressure determination time	Typical: 15 seconds Maximum: 150 seconds
Blood pressure accuracy	Meets or exceeds ANSI.AAMI SP10:2002 standards for noninvasive blood pressure accuracy (± 5 mmHg mean error, 8 mmHg standard deviation)
Mean Arterial Pressure (MAP) range The formula used to calculate MAP yields an approximate value.	Adult: 23 to 230 mmHg (StepBP, SureBP) Pediatric: 23 to 230 mmHg (StepBP, SureBP) Neonate: 13 to 110 mmHg (StepBP)
Pulse rate range (using blood pressure determination)	Adult: 30 to 200 bpm (StepBP, SureBP) Pediatric: 30 to 200 bpm (StepBP, SureBP) Neonate: 35 to 220 bpm (StepBP)
Pulse rate accuracy (using blood pressure determination)	$\pm 5.0\%$ (± 3 bpm)
Overpressure cutoff	Adult: 300 mmHg ± 15 mmHg Pediatric: 300 mmHg ± 15 mmHg Neonate: 150 mmHg maximum

SureTemp Plus temperature module specifications

Temperature range	80°F to 110°F (26.7°C to 43.3°C)
Calibration accuracy	$\pm 0.2^\circ\text{F}$ ($\pm 0.1^\circ\text{C}$) (Direct mode)

Braun ThermoScan PRO 4000 thermometer specifications (refer to manufacturer's directions for use for additional information)

Temperature range	68°F to 108°F (20°C to 42.2°C)
Calibration accuracy	<ul style="list-style-type: none"> ±0.4°F (±0.2°C) for temperatures ranging from 95.9°F to 107.6°F (35.5°C to 42°C) ±0.5°F (±0.25°C) for temperatures outside of this range
Display resolution	0.1°F or °C

SpO2 specifications (refer to sensor manufacturer's directions for use for additional information)

SpO2 performance measurement range	1 to 100%
------------------------------------	-----------

Masimo SpO2 sensor accuracy guide	Accuracy specified when used with Masimo SET pulse oximetry monitors or with licensed Masimo SET pulse oximetry modules using PC series patient cables, during no motion. Numbers present ± 1 standard deviation. Plus or minus one standard deviation represents 68% of the population.
--	--

Perfusion	0.02 % to 20 %
-----------	----------------

Pulse rate	25 to 240 beats per minute (bpm) No motion: ± 3 digits Motion: ± 5 digits
------------	---

Saturation	70% to 100%
Note	Saturation accuracy varies by sensor type.
	Adults, Pediatrics (No motion): ± 2 digits Neonates (No motion): ± 3 digits Adults, Pediatrics, Neonates (Motion): ± 3 digits Low Perfusion: 0.02 % to 20 % ± 2 digits

Nellcor sensor accuracy guide	SpO2 measurement accuracy can only be evaluated in vivo by comparing pulse oximeter readings with SaO2 measurements obtained from simultaneously sampled arterial blood made using a laboratory CO-oximeter. SpO2 accuracy was validated through breathe-down-equivalent testing by Covidien using electronic measurements to prove equivalence to the Nellcor N600x predicate device. The Nellcor N600x predicate device was validated by performing human-subject, "breathe-down" clinical trials.
--------------------------------------	--

Perfusion	0.03 % to 20 %
-----------	----------------

Pulse rate	20 to 250 beats per minute (bpm) ± 3 digits
------------	---

Saturation	70% to 100%
Note	Saturation accuracy varies by sensor type.
	Adult, Pediatrics: ± 2 digits Neonate: ± 3 digits Low Perfusion: 0.02 % to 20 % ± 2 digits

SpO2 specifications (refer to sensor manufacturer's directions for use for additional information)

Functional tester



WARNING Functional testers cannot be used to assess the accuracy of a pulse oximeter monitor.
1

¹ Some models of commercially available bench-top functional testers and patient simulators can be used to verify the proper functionality of Nellcor pulse oximeter sensors, cables and monitors. See the individual testing device's operator's manual for the procedures specific to the model of tester being used.

While such devices may be useful for verifying that the pulse oximeter sensor, cabling, and monitor are functional, they are incapable of providing the data required to properly evaluate the accuracy of a system's SpO2 measurements. Fully evaluating the accuracy of the SpO2 measurements requires, at a minimum, accommodating the wavelength characteristics of the sensor and reproducing the complex optical interaction of the sensor and the patient's tissue. These capabilities are beyond the scope of known bench-top testers. SpO2 measurement accuracy can only be evaluated in vivo by comparing pulse oximeter readings with SaO2 measurements obtained from simultaneously sampled arterial blood made using a laboratory CO-oximeter.

Many functional testers and patient simulators have been designed to interface with the pulse oximeter's expected calibration curves and may be suitable for use with Nellcor monitors and/or sensors. Not all such devices, however, are adapted for use with the Nellcor OXIMAX digital calibration system. While this will not affect use of the simulator for verifying system functionality, displayed SpO2 measurement values may differ from the setting of the test device. For a properly functioning monitor, this difference will be reproducible over time and from monitor to monitor within the performance specifications of the test device.

SpHb specifications (refer to sensor manufacturer's directions for use for additional information)

SpHb saturation range

0 to 25 g/dL

Masimo SpHb sensor accuracy guide

Adults, Pediatrics (no motion): 8 to 17 g/dL \pm 1 g/dL. SpHb accuracy has been validated on healthy adult male and female volunteers and on surgical patients with light to dark skin pigmentation in the range of 8 to 17 g/dL SpHb against a laboratory co-oximeter. This variation equals \pm 1 standard deviation which encompasses 68% of the population. The SpHb accuracy has not been validated with motion or low perfusion.

Environmental specifications

Operating temperature

50°F to 104°F (10°C to 40°C)

Storage temperature

-4°F to 122°F (-20°C to 50°C)

Operating altitude

-557 to 10,000 ft. (-170 m to 3,048 m)

Operating humidity

15 to 95% noncondensing

Storage humidity

15% to 95% noncondensing

Monitor radio

The monitor's radio operates on Welch Allyn FlexNet™ or other 802.11 networks.

Wireless network interface	IEEE 802.11 b/g, 802.11a
Frequency	802.11 b/g: 2.402 GHz to 2.4835 GHz
	802.11a: 5.125 GHz to 5.875 GHz
Channels	Up to 14 in 802.11b/g, up to 24 in 802.11a; country-dependent
Security/encryption/authentication	WPA2/AES (either EAP or PSK authentication)
Antenna	Internal multiband PIFA
Wireless data rates	802.11b: 1Mbps or higher during vitals transmission only
	802.11a/g: 6Mbps or higher during vitals transmission only
	(approximately 2 seconds per reading)
Agency approvals	US: FCC Part 15, Class B; C/UL; CE; 47 CFR Part 2.1093, 15.207, 15.209, 15.247, 15.407; FCC OET Bulletin 65C
	Europe: CE; EN 50371; EN/ETSI 300 328 V1.7.1, 301 489-1 V1.6.1, 301 489-17 V1.2.1, 301 893 V1.4.1
	Canada: RSS-210; RSS-GEN; RSS-102
	Hong Kong: HKTA 1039
Protocols	UDP, DHCP, TCP/IP
Data transfer protocols	UDP/TCP/IP
Modulation	OFDM (802.11a/g), DSSS/CCK (802.11b)
Output power	40mW typical, country-dependent
Ancillary IEEE standards	802.11e, 802.11h, 802.11i, 802.11X

Channel restrictions in the 5-GHz band are determined by country.

Marking by the symbol (!) indicates that usage restrictions apply. To ensure compliance with local regulations, be sure the correct country in which the access point is installed is selected. This product can be used with the following restriction(s):

France - Outdoor use is limited to 10 mW EIRP within the band 2454 to 2483.5 MHz.

Note Effective Isotropic Radiated Power (EIRP).

Note Some countries restrict the use of 5-GHz bands. The 802.11a radio in the monitor uses only the channels indicated by the access point with which the radio associates. The hospital IT department must configure access points to operate with approved domains.

Configuration options

The monitor is available in multiple configurations.

Model	Description
6300	Basic. Includes USB connectivity. Ethernet connectivity is optional.
6400	Standard. Includes nurse call, Ethernet, and USB connectivity. The radio is optional.
6500	Wireless. Includes all Standard features plus an internal 802.11 a/b/g radio.

Patents

The monitor is covered under the following patents:

6,000,846; 6,036,361; 7,255,475; 7,429,245; D480,977; D632,397; and other patents pending.

For SureTemp Plus configured monitors, US patent 6,971,790 applies.

For Nellcor-equipped monitors, the following Nellcor US patents and foreign equivalents apply:

5,485,847; 5,676,141; 5,743,263; 6,035,223; 6,226,539; 6,411,833; 6,463,310; 6,591,123; 6,708,049;
7,016,715; 7,039,538; 7,120,479; 7,120,480; 7,142,142; 7,162,288; 7,190,985; 7,194,293; 7,209,774;
7,212,847; 7,400,919.

For Masimo-equipped monitors, the following Masimo US patents and foreign equivalents apply:

5,758,644; 5,823,950; 6,011,986; 6,157,850; 6,263,222; 6,501,975; 7,469,157; and others listed at www.masimo.com/patents.htm.

Standards and compliance

General compliance and standards

The monitor complies with the following standards:

21 CFR Subchapter H – Medical Devices – US Food and Drug Administration
 2002 No. 236 – Australian Therapeutic Goods Act
 93/42/EEC – European Economic Community Medical Devices Directive
 2007/47/EC – European Economic Community Medical Devices Directive 2007 Amendment
 94/62/EC – European Economic Community Packaging Directive
 2002/96/EC – European Economic Community Waste Electrical and Electronic Equipment Directive
 2006/66/EC – European Economic Community Batteries and Accumulators Directive
 SOR/98-282 – Canadian Medical Devices Regulation
 IATA DGR – International Air Transport Association Dangerous Goods Regulation
 United Nations ST/SG/AC.10/11 – Manual of Tests and Criteria, Part III, Sub-Section 38.3

ANSI/AAMI SP10

AS/NZS 3200.1.0¹

ASTM D 4332, E 1104

CAN/CSA C22.2 NO.601.1¹ CAN/CSA-C22.2 NO.60601-1-2, CSA Z9919

EN 1060-1, 1060-3, 1060-4²

EN/IEC 60601-1, 60601-1-2, 60601-1-4, 60601-1-6, 60601-1-8, 60601-2-30, 60601-2-49, 62304

EN/ISO 9919, 13485, 14971

ISTA 2A

UL 60601-1¹



Directive 2002/96/EC-WEEE:

Disposal of noncontaminated electrical and electronic equipment

This product and its accessories must be disposed of according to local laws and regulations. Do not dispose of this product as unsorted municipal waste. Prepare this product for reuse or separate collection as specified by Directive 2002/96/EC of the European Parliament and the Council of the European Union on Waste Electrical and Electrical Equipment (WEEE). If this product is contaminated, this directive does not apply.

¹ Standard is essentially the IEC 60601-1 General standard plus the listed country's National Deviations.

² Non-Invasive Sphygmomanometers – Part 1: General Requirements, Part 3. Supplementary Requirements for Electro-Mechanical Blood Pressure Measuring Systems, Part 4: Test Procedures to Determine the Overall System Accuracy of Automated Non-Invasive Sphygmomanometers.

For more specific disposal or compliance information, see www.welchallyn.com/weee, or contact Welch Allyn Customer Service at +44 207 365 6780.

General radio compliance

The wireless features of this monitor must be used in strict accordance with the manufacturer's instructions as described in the user documentation that comes with the product.

This device complies with Part 15 of the FCC rules and with the rules of the Canadian ICES-003 as described below.

Federal Communications Commission (FCC)

This device complies with part 15 of the FCC Rules. Operation is subject to the following two conditions:

- This device may not cause harmful interference.
- This device must accept any interference received, including interference that may cause undesired operation.

This equipment has been tested and found to comply with the limits for a Class B digital device, pursuant to Part 15 of FCC Rules. These limits are designed to provide reasonable protection against harmful interference in a residential installation. This equipment generates, uses, and can radiate radio frequency energy. If not installed and used in accordance with the instructions, it may cause harmful interference to radio communications. However, there is no guarantee that interference will not occur in a particular installation. If this equipment does cause harmful interference to radio or television reception, which can be determined by turning the equipment off and on, the user is encouraged to try and correct the interference by one or more of the following measures:

- Reorient or relocate the receiving antenna
- Increase the distance between the equipment and the receiver
- Connect the equipment to an outlet on a circuit different from that to which the receiver is connected
- Consult the dealer or an experienced radio/TV technician for help

The user may find the following booklet prepared by the Federal Communications Commission helpful:

The Interference Handbook

This booklet is available from the U.S. Government Printing Office, Washington, D.C. 20402. Stock No. 004-000-0034504.

Welch Allyn is not responsible for any radio or television interference caused by unauthorized modification of the devices included with this Welch Allyn product, or the substitution or attachment of connecting cables and equipment other than specified by Welch Allyn.

The correction of interference caused by such unauthorized modification, substitution, or attachment will be the responsibility of the user.

Industry Canada (IC) emissions

This device complies with RSS 210 of Industry Canada.

Operation is subject to the following two conditions: (1) this device may not cause interference, and (2) this device must accept any interference, including interference that may cause undesired operation of this device.

L'utilisation de ce dispositif est autorisée seulement aux conditions suivantes: (1) il ne doit pas produire de brouillage et (2) l'utilisateur du dispositif doit être prêt à accepter tout brouillage radioélectrique reçu, même si ce brouillage est susceptible de compromettre le fonctionnement du dispositif.

This Class B digital apparatus complies with Canadian ICES-003.

Cet appareil numérique de la classe B est conforme à la norme NMB-003 du Canada.

European Union

Czech	Welch Allyn tímto prohlašuje, že tento RLAN device je ve shodě se základními požadavky a dalšími příslušnými ustanoveními směrnice 1999/5/ES.
Danish	Undertegnede Welch Allyn erklærer herved, at følgende udstyr RLAN device overholder de væsentlige krav og øvrige relevante krav i direktiv 1999/5/EF
Dutch	Bij deze verklaart Welch Allyn dat deze RLAN device voldoet aan de essentiële eisen en aan de overige relevante bepalingen van Richtlijn 1999/5/EC.
English	Hereby, Welch Allyn, declares that this RLAN device is in compliance with the essential requirements and other relevant provisions of Directive 1999/5/EC.
Estonian	Käesolevaga kinnitab Welch Allyn seadme RLAN device vastavust direktiivi 1999/5/EÜ põhinõuetele ja nimetatud direktiivist tulenevatele teistele asjakohastele sätetele.
Finnish	Welch Allyn vakuuttaa täten että RLAN device tyyppinen laite on direktiivin 1999/5/EY oleellisten vaatimusten ja sitä koskevien direktiivin muiden ehtojen mukainen.
French	Par la présente, Welch Allyn déclare que ce RLAN device est conforme aux exigences essentielles et aux autres dispositions de la directive 1999/5/CE qui lui sont applicables
German	Hiermit erklärt Welch Allyn die Übereinstimmung des Gerätes RLAN device mit den grundlegenden Anforderungen und den anderen relevanten Festlegungen der Richtlinie 1999/5/EG. (Wien)
Greek	ΜΕ ΤΗΝ ΠΑΡΟΥΣΑ Welch Allyn ΔΗΛΩΝΕΙ ΟΤΙ RLAN device ΣΥΜΜΟΡΦΩΝΕΤΑΙ ΠΡΟΣ ΤΙΣ ΟΥΣΙΩΔΕΙΣ ΑΠΑΙΤΗΣΕΙΣ ΚΑΙ ΤΙΣ ΛΟΙΠΕΣ ΣΧΕΤΙΚΕΣ ΔΙΑΤΑΞΕΙΣ ΤΗΣ ΟΔΗΓΙΑΣ 1999/5/EK
Hungarian	Alulírott, Welch Allyn nyilatkozom, hogy a RLAN device megfelel a vonatkozó alapvető követelményeknek és az 1999/5/EC irányelv egyéb előírásainak.
Italian	Con la presente Welch Allyn dichiara che questo RLAN device è conforme ai requisiti essenziali ed alle altre disposizioni pertinenti stabilite dalla direttiva 1999/5/CE.
Latvian	Ar šo Welch Allyn deklarē, ka RLAN device atbilst Direktīvas 1999/5/EK būtiskajām prasībām un citiem ar to saistītajiem noteikumiem.
Lithuanian	Šiuo Welch Allyn deklaruoja, kad šis RLAN device atitinka esminius reikalavimus ir kitas 1999/5/EB Direktyvos nuostatas.
Malti	Hawnhekk, Welch Allyn, jiddikjara li dan RLAN device jikkonforma mal-htigijiet essenzjali u ma provvedimenti oħrajn relevanti li hemm fid-Dirrettiva 1999/5/EC

Portuguese	Welch Allyn declara que este RLAN device está conforme com os requisitos essenciais e outras disposições da Directiva 1999/5/CE.
Slovak	Welch Allyn týmto vyhlasuje, ze RLAN device spĺňa základné požiadavky a všetky príslušné ustanovenia Smernice 1999/5/ES.
Slovene	Šiuo Welch Allyn deklaruoja, kad šis RLAN device atitinka esminius reikalavimus ir kitas 1999/5/EB Direktyvos nuostatas.
Spanish	Por medio de la presente Welch Allyn declara que el RLAN device cumple con los requisitos esenciales y cualesquiera otras disposiciones aplicables o exigibles de la Directiva 1999/5/CE
Swedish	Härmed intygar Welch Allyn att denna RLAN device står i överensstämmelse med de väsentliga egenskapskrav och övriga relevanta bestämmelser som framgår av direktiv 1999/5/EG.

Guidance and manufacturer's declaration

EMC compliance

Special precautions concerning electromagnetic compatibility (EMC) must be taken for all medical electrical equipment. This device complies with IEC EN 60601-1-2:2007.

- All medical electrical equipment must be installed and put into service in accordance with the EMC information provided in this document and the *Welch Allyn Connex Vital Signs Monitor 6000 Series Directions for Use*.
- Portable and mobile RF communications equipment can affect the behavior of medical electrical equipment.

The monitor complies with all applicable and required standards for electromagnetic interference.

- It does not normally affect nearby equipment and devices.
- It is not normally affected by nearby equipment and devices.
- It is not safe to operate the monitor in the presence of high-frequency surgical equipment.
- However, it is good practice to avoid using the monitor in extremely close proximity to other equipment.

Emissions and immunity information

Electromagnetic emissions

The monitor is intended for use in the electromagnetic environment specified below. The customer or user of the monitor should assure that it is used in such an environment.

Emissions test	Compliance	Electromagnetic environment - guidance
RF emissions CISPR 11	Group 1	The monitor uses RF energy only for its internal function. Therefore, its RF emissions are very low and are not likely to cause any interference in nearby electronic equipment.
RF emissions CISPR 11	Class A	The monitor is suitable for use in all establishments other than domestic establishments and those directly connected to the public low-voltage power supply network that supplies buildings used for domestic purposes, provided the following warning is heeded:
Harmonic emissions IEC 61000-3-2	Class A	

Electromagnetic emissions

Voltage fluctuations/ flicker emissions
Complies
IEC 61000-3-3



WARNING This equipment/system is intended for use by healthcare professionals only. This equipment/ system may cause radio interference or may disrupt the operation of nearby equipment^a. It may be necessary to take mitigation measures, such as re-orienting or relocating the monitor or shielding the location.

^a The monitor contains a 5-GHz orthogonal frequency-division multiplexing transmitter or a 2.4-GHz frequency hopping spread-spectrum transmitter for the purpose of wireless communication. The radio is operated according to the requirements of various agencies, including FCC 47 CFR 15.247 and R&TTE Directive (1995/5/EC). The transmitter is excluded from the EMC requirements of 60601-1-2, but should be considered when addressing possible interference issues between this and other devices.

Electromagnetic immunity

The monitor is intended for use in the electromagnetic environment specified below. The customer or the user of the monitor should assure that it is used in such an environment.

Immunity test	IEC 60601 test level	Compliance level	Electromagnetic environment - guidance
Electrostatic discharge (ESD) IEC 61000-4-2	±6 kV contact ± 8 kV air	± 6 kV contact ± 8 kV air	Floors should be wood, concrete or ceramic tile. If floors are covered with synthetic material, the relative humidity should be at least 30%.
Electrical fast transient/burst IEC 61000-4-4	±2 kV for power supply lines ±1 kV for input/output lines	±2 kV for power supply lines ±1 kV for input/output lines	Mains power quality should be that of a typical commercial or hospital environment.
Surge IEC 61000-4-5	± 1 kV differential mode ± 2 kV common mode	± 1 kV differential mode ± 2 kV common mode	Mains power quality should be that of a typical commercial or hospital environment.
Voltage dips, short interruptions and voltage variations on power supply input lines IEC 61000-4-11	>95% dip in 0.5 cycle 60% dip in 5 cycles 30% dip for 25 cycles >95% dip in 5 seconds	>95% dip in 0.5 cycle 60% dip in 5 cycles 30% dip for 25 cycles >95% dip in 5 seconds	Mains power quality should be that of a typical commercial or hospital environment. If the user of the monitor requires continued operation during power mains interruptions, it is recommended that the monitor be powered from an uninterruptible power supply or a battery.

Electromagnetic immunity

The monitor is intended for use in the electromagnetic environment specified below. The customer or the user of the monitor should assure that it is used in such an environment.

Immunity test	IEC 60601 test level	Compliance level	Electromagnetic environment - guidance
---------------	----------------------	------------------	--

Electromagnetic immunity

Portable and mobile RF communications equipment should be used no closer to any part of the monitor, including cables, than the recommended separation distance calculated from the equation applicable to the frequency of the transmitter.

Recommended separation distance

Conducted RF IEC 61000-4-6	3 Vrms 150 kHz to 80 MHz	3 Vrms	$d = (1.17) \sqrt{P}$
Radiated RF IEC 61000-4-3	3 V/m 80 MHz to 1 GHz	3 V/m	$d = (1.17) \sqrt{P}$ 80 to 800 MHz

$$d = (2.33) \sqrt{P} \text{ 800 MHz to 2,5 GHz}$$

where P is the maximum output power rating of the transmitter in watts (W) and d is the recommended separation distance in meters (m). Field strengths from fixed RF transmitters, as determined by an electromagnetic site survey^a, should be less than the compliance level in each frequency range^b. Interference may occur in the vicinity of equipment marked with the following symbol:



Note1: At 80 MHz and 800 MHz, the higher frequency range applies.

Note 2: These guidelines may not apply in all situations. Electromagnetic propagation is affected by absorption and reflection from structures, objects, and people.

^aField strengths from fixed transmitters, such as base stations for radio (cellular/cordless) telephones and land mobile radios, amateur radio, AM and FM radio broadcast, and TV broadcast cannot be predicted theoretically with accuracy. To assess the electromagnetic environment due to fixed RF transmitters, an electromagnetic site survey should be considered. If the measured field strength in the location in which the monitor is used exceeds the applicable RF compliance level above, the monitor should be observed to verify normal operation. If abnormal performance is observed, additional measures may be necessary, such as reorienting or relocating the monitor.

^bOver the frequency range 150 kHz to 80 MHz, field strengths should be less than 3 V/m.

Recommended separation distances between portable and mobile RF communications equipment and the monitor

The monitor is intended for use in an electromagnetic environment in which radiated RF disturbances are controlled. The customer or user of the monitor can help prevent electromagnetic interference by maintaining a minimum distance between portable and mobile RF communications equipment (transmitters) and the monitor as recommended below, according to the maximum output power of the communications equipment.

Separation distance according to frequency of transmitter (m)

Recommended separation distances between portable and mobile RF communications equipment and the monitor

Rated max. output power of transmitter (W)	150 kHz to 80 MHz	80 MHz to 800 MHz	800 MHz to 2.5 GHz
	$d = (1.17) \sqrt{P}$	$d = (1.17) \sqrt{P}$	$d = (2.23) \sqrt{P}$
0.01	0.11667	0.11667	0.23333
0.1	0.36894	0.36894	0.73785
1	1.1667	1.1667	2.3333
10	3.6894	3.6894	7.3785
100	11.667	11.667	23.3333

For transmitters rated at a maximum output power not listed above, the recommended separation distance d in meters (m) can be estimated using the equation applicable to the frequency of the transmitter, where P is the maximum output power rating of the transmitter in watts (W) according to the transmitter manufacturer.

Note 1: At 80 MHz and 800 MHz, the separation distance for the higher frequency range applies.

Note 2: These guidelines may not apply in all situations. Electromagnetic propagation is affected by absorption and reflection from structures, objects, and people.

Advanced settings

The Advanced tab provides password-protected access to the monitor's Advanced settings (or Admin mode), enabling nurse administrators, biomedical engineers, and/or service engineers to configure specific features. The Advanced tab also presents read-only information about the monitor.

Note You cannot enter the Advanced settings if sensors or physiological alarms are active or if vital sign measurements are displayed.

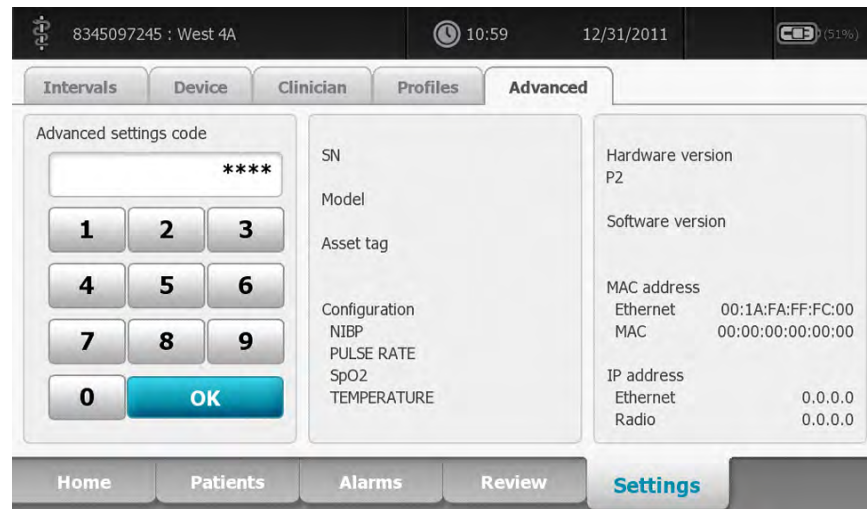

General

Specify the language

1. Access the Advanced Settings.
 - a. Touch the **Settings** tab.
 - b. Touch the **Advanced** tab.
 - c. Enter the **Advanced settings code**.
 - d. Touch **OK**.

The General tab appears, displaying the Language tab.
2. Select a language.
3. Do one of the following:
 - To continue in the Advanced Settings, touch another tab.

- To exit the Advanced Settings and return to the Home tab, touch **Exit**.

Specify date and time settings

1. Access the Advanced Settings.
 - a. Touch the **Settings** tab.
 - b. Touch the **Advanced** tab.
 - c. Enter the **Advanced settings code**.
 - d. Touch **OK**.

The General tab appears.

2. On the General tab, touch the **Date / Time** tab.
3. Specify settings.

Setting	Action/Description
Date format	Select a date format for display.
Time zone	Select your time zone offset from Coordinated Universal Time (UTC).
Automatically adjust clock for daylight saving time, reported by host	Select this to adjust the displayed time by +/- one hour when the connected host reports daylight savings time.
Allow users to change date and time	Select this to allow clinicians to set the date and time from the Settings tab.
Display date and time	Select this to display the date and time on the Home tab in the Device Status area.

4. Do one of the following:
 - To continue in the Advanced Settings, touch another tab.
 - To exit the Advanced Settings and return to the Home tab, touch **Exit**.

Specify advanced alarm settings

1. Access the Advanced Settings.
 - a. Touch the **Settings** tab.
 - b. Touch the **Advanced** tab.
 - c. Enter the **Advanced settings code**.
 - d. Touch **OK**.

The General tab appears.

2. Touch the **Alarms** tab.
3. Specify settings.

Setting	Action/Description
Allow user to disable alarms	Select to allow clinicians to turn off or turn on all alarm limits for each vital sign. The control is on each parameter-specific tab on the Alarms tab.
Allow user to turn off general audio	Select to allow clinicians to turn off all audio notification for alarms. This control is on the Alarms tab (on the General tab).

Minimum alarm volume	Select the minimum alarm volume available. If you select High , then Medium and Low are not available to the clinician. These controls are on the Alarms tab (on the General tab).
Nurse call threshold	Select the minimum priority alarm that activates a nurse call relay. If you select High , only high-level alarms activate a nurse call relay.
Audio pause time	Specify the amount of pause time that is added to the 60-second pause time. When a clinician pauses an audio alarm tone, the tone is paused for the combined amount of time.
SpO2 alarm condition delay	Specify the minimum amount of time that an SpO2 alarm condition must be active before audio and visual signals occur. SatSeconds is available with Nellcor SpO2 sensors. If you select 0 seconds or 10 seconds, SatSeconds is disabled, and it is removed from the SpO2 tab in the Alarms tab.
SpHb alarm condition delay	Specify the minimum amount of time that an SpHb alarm condition must be active before audio and visual signals occur.

4. Do one of the following:
 - To continue in the Advanced Settings, touch another tab.
 - To exit the Advanced Settings and return to the Home tab, touch **Exit**.

Specify advanced display settings

1. Access the Advanced Settings.
 - a. Touch the **Settings** tab.
 - b. Touch the **Advanced** tab.
 - c. Enter the **Advanced settings code**.
 - d. Touch **OK**.

The General tab appears.

2. Touch the **Display** tab.
3. Specify settings.

Setting

Display lock

Action/Description

Specify the required period of clinician inactivity before the touchscreen locks.

Display power saver

Specify the required period of monitor inactivity before the display turns off.

Clinician interactions, new vital sign measurements, or alarm conditions automatically turn on the display.

Device power down

Specify the required period of monitor inactivity before the monitor turns off.

4. Do one of the following:
 - To continue in the Advanced Settings, touch another tab.
 - To exit the Advanced Settings and return to the Home tab, touch **Exit**.

Specify a monitor location

You can associate the monitor with a specific location. The location appears in the Device Status area.

1. Access the Advanced Settings.
 - a. Touch the **Settings** tab.
 - b. Touch the **Advanced** tab.
 - c. Enter the **Advanced settings code**.
 - d. Touch **OK**.

The General tab appears.

2. Touch the **Other** tab.
3. In the **Location ID** box, touch  and enter up to 20 alphanumeric characters.
4. Do one of the following:
 - To continue in the Advanced Settings, touch another tab.
 - To exit the Advanced Settings and return to the Home tab, touch **Exit**.

Enable monitor profile changes

You can allow clinicians to change the active profile on the monitor. Available profiles are **Monitor**, **Spot Check**, and **Triage**. When this option is enabled, clinicians can change the name of the profile as well.

1. Access the Advanced Settings.
 - a. Touch the **Settings** tab.
 - b. Touch the **Advanced** tab.
 - c. Enter the **Advanced settings code**.
 - d. Touch **OK**.

The General tab appears.

2. Touch the **Other** tab.
3. Select **Allow profile change**.
4. Do one of the following:
 - To continue in the Advanced Settings, touch another tab.
 - To exit the Advanced Settings and return to the Home tab, touch **Exit**.

Specify power line frequency

1. Access the Advanced Settings.
 - a. Touch the **Settings** tab.
 - b. Touch the **Advanced** tab.
 - c. Enter the **Advanced settings code**.
 - d. Touch **OK**.

The General tab appears.

2. Touch the **Other** tab.

3. Select the power line frequency for AC power supplied to the monitor.
4. Do one of the following:
 - To continue in the Advanced Settings, touch another tab.
 - To exit the Advanced Settings and return to the Home tab, touch **Exit**.

Set and start the demo mode

1. Access the Advanced Settings.
 - a. Touch the **Settings** tab.
 - b. Touch the **Advanced** tab.
 - c. Enter the **Advanced settings code**.
 - d. Touch **OK**.

The General tab appears.

2. Touch the **General** tab.
3. Touch the **Demo** tab.
4. Specify settings.

Setting

Type

Start

Action/Description

Select a type of demonstration mode.

Touch **Start** to put the monitor in demonstration mode. Navigate to the Home tab to begin Demo mode.

5. Do one of the following:
 - To continue in the Advanced Settings, touch another tab.
 - To exit the Demo mode, touch **Exit** on the Home tab. The monitor restarts automatically.

Parameters

Specify advanced NIBP settings

1. Access the Advanced Settings.
 - a. Touch the **Settings** tab.
 - b. Touch the **Advanced** tab.
 - c. Enter the **Advanced settings code**.
 - d. Touch **OK**.

The General tab appears.

2. Touch the **Parameters** tab.
3. Touch the **NIBP** tab.
4. Specify settings.

Setting

Default view

Action/Description

Select primary and secondary views.

Select **Display MAP** to display mean arterial pressure (MAP) in the NIBP frame on the Home tab.

Default patient type	If Display MAP is selected, specify which numerics are primary in the NIBP frame. On the Home tab, clinicians can touch the NIBP frame to toggle between views. Select a default patient type for this monitor. The patient type shows in the Patient frame on the Home tab. In the Patients tab on the Summary tab, clinicians can change the displayed patient type from the default patient type that you set here.
Tube type	Select the number of tubes that are connected to the NIBP cuff that is used with this monitor. If you select 1 tube , the only algorithm available for selection is Step .
Unit of measure	Select the NIBP unit of measure for display.
Allow interval program changes	Enable clinicians to modify interval program settings from the Intervals tab.
Algorithm and Cuff inflation target (CIT)	Select the default algorithm used to determine NIBP measurements.

If you select the **Step** algorithm, touch  and enter a default cuff inflation target for each type of patient. In the Patients tab on the Summary tab, clinicians can change the CITs from the default CITs that you set here.

5. Do one of the following:
 - To continue in the Advanced Settings, touch another tab.
 - To exit the Advanced Settings and return to the Home tab, touch **Exit**.

Specify advanced temperature settings

1. Access the Advanced Settings.
 - a. Touch the **Settings** tab.
 - b. Touch the **Advanced** tab.
 - c. Enter the **Advanced settings code**.
 - d. Touch **OK**.

The General tab will appear.

2. Touch the **Parameters** tab.
3. Touch the **Temperature** tab.
4. Specify settings.

Setting

Unit of measure

Display temperature conversion

Default SureTemp Plus site

Action/Description

Select primary units of measure for the temperature display on the Home tab

Select this to display primary units of measure and secondary units of measure for the temperature display on the Home tab.

Select the default site for SureTemp measurements. The default site applies when clinicians power up the monitor and each time

clinicians remove the temperature probe from the well.

Select **Last Site** to set the default to the site selected for the last measurement.

5. Do one of the following:
 - To continue in the Advanced Settings, touch another tab.
 - To exit the Advanced Settings and return to the Home tab, touch **Exit**.

Specify advanced SpO2 settings

1. Access the Advanced Settings.
 - a. Touch the **Settings** tab.
 - b. Touch the **Advanced** tab.
 - c. Enter the **Advanced settings code**.
 - d. Touch **OK**.

The General tab appears.

2. Touch the **Parameters** tab.
3. Touch the **SpO2** tab.
4. Specify settings.

Setting

Default view

Default response

Sweep speed

Action/Description

Select a numeric view or a waveform view as the primary SpO2 display on the Home tab.

Select the default speed of response to changes in SpO2 measurements.

Select the waveform sweep speed for the SpO2 display in the Home tab.

5. Do one of the following:
 - To continue in the Advanced Settings, touch another tab.
 - To exit the Advanced tabs and return to the Home tab, touch **Exit**.

Specify advanced SpHb settings

1. Access the Advanced Settings.
 - a. Touch the **Settings** tab.
 - b. Touch the **Advanced** tab.
 - c. Enter the **Advanced settings code**.
 - d. Touch **OK**.

The General tab appears.

2. Touch the **Parameters** tab.
3. Touch the **SpHb** tab.
4. Specify settings.

Setting

Reference

Action/Description

Select arterial or venous as the calibrated reference source.

Unit of measure	Select the primary unit of measure for the SpHb display on the Home tab.
Default averaging	Select the default moving window of time used by the parameter to calculate the SpHb value and update the display: short (approximately 1 minute), medium (approximately 3 minutes), or long (approximately 6 minutes).
Trend view time	Select the period displayed in the SpHb trend graphic on the Home tab.
5. Do one of the following:	
<ul style="list-style-type: none"> To continue in the Advanced Settings, touch another tab. To exit the Advanced tabs and return to the Home tab, touch Exit. 	

Specify advanced pulse rate settings

1. Access the Advanced Settings.
 - a. Touch the **Settings** tab.
 - b. Touch the **Advanced** tab.
 - c. Enter the **Advanced settings code**.
 - d. Touch **OK**.

The General tab appears.

2. Touch the **Parameters** tab.
3. Touch the **Pulse rate** tab.
4. Specify settings.

Setting

Display source

Action/Description

Select this to show the source of pulse rate measurements (NIBP or SpO2) on the Home tab.

5. Do one of the following:
 - To continue in the Advanced Settings, touch another tab.
 - To exit the Advanced Settings and return to the Home tab, touch **Exit**.

Specify the manual parameters

The Manual Parameters frame is in the lower right corner of the Home tab. You can manually enter values for parameters in the frame. You also can specify which parameters appear in the frame.

1. Access the Advanced Settings.
 - a. Touch the **Settings** tab.
 - b. Touch the **Advanced** tab.
 - c. Enter the **Advanced settings code**.
 - d. Touch **OK**.

The General tab appears.

2. Touch the **Parameters** tab.
3. Touch the **Manual** tab.

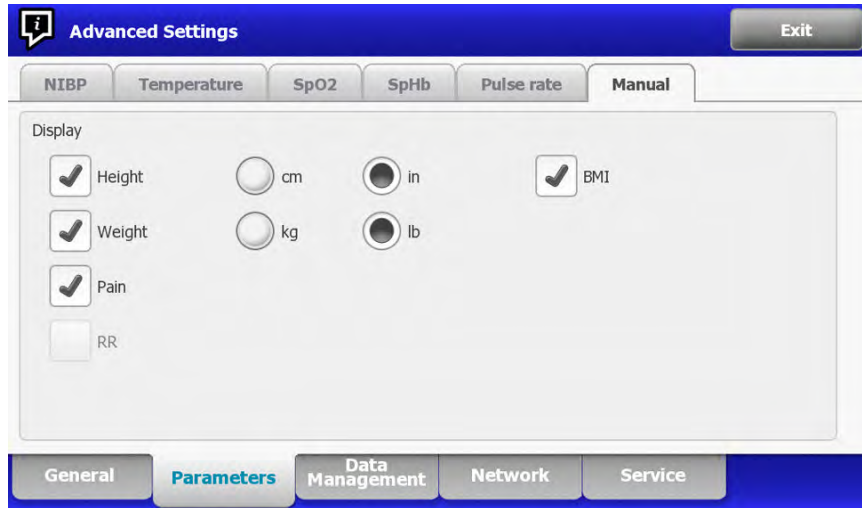

4. Select up to four parameters and associated units of measure for display in the Manual Parameters frame.

If the monitor has the SureTemp Plus temperature module, the **Temperature** parameter is not available here or in the Manual Parameters frame.

5. Do one of the following:
 - To continue in the Advanced Settings, touch another tab.
 - To exit the Advanced Settings and return to the Home tab, touch **Exit**.

Data management

Specify patient ID settings

Patient identification appears on the Home tab in the Patient frame, and it is listed in various tabs, such as the Patient tab and the Review tab.

1. Access the Advanced Settings.
 - a. Touch the **Settings** tab.
 - b. Touch the **Advanced** tab.
 - c. Enter the **Advanced settings code**.
 - d. Touch **OK**.

The General tab appears.

2. Touch the **Data Management** tab.
3. Touch the **Patient IDs** tab.
4. Specify settings.

Setting

Name format

Primary label

Secondary label

Action/Description

Select a format for all displayed patient names:
Full name or **Abbreviation**.

Select the primary identification label for all displayed patients.

Select a secondary identification label for patients. A secondary label displays only on the Home tab, after the primary label.

Require patient ID to save readings	Make entering a patient ID a prerequisite for saving measurements. If they fail to enter an identifier, the monitor prompts them when they try to save.
Search by patient ID	Enable clinicians to enter a patient ID to query for the patient's information. If clinicians scan the ID onto the Home tab or the Summary tab, the monitor queries the patient list and the network. Returned patient information populates the Patient frame on the Home tab and fields on the Summary tab.
Clear patient information on manual save	Specify that the monitor clears the selected patient after a clinician manually saves measurements from the Home tab. Patient information clears from the Patient frame and the Summary tab. Note: This setting does not take effect when intervals are in progress.
Retrieve list	Enable the monitor to retrieve the patient list from the network. When this option is selected, a Retrieve list button replaces the Add button on the List tab. Information from the network populates the List tab when clinicians touch the Retrieve list button. Since the Add button is not available, clinicians cannot add a patient to the patient list.

5. Do one of the following:

- To continue in the Advanced Settings, touch another tab.
- To exit the Advanced Settings and return to the Home tab, touch **Exit**.

Specify clinician ID settings

Clinician identification appears next to the medicine symbol in the Device Status area on the Home tab.

1. Access the Advanced Settings.
 - a. Touch the **Settings** tab.
 - b. Touch the **Advanced** tab.
 - c. Enter the **Advanced settings code**.
 - d. Touch **OK**.

The General tab appears.

2. Touch the **Data Management** tab.
3. Touch the **Clinician IDs** tab.
4. Specify settings.

Setting

Label

Action/Description

Select a type of clinician identification label for display on the Home tab: **Full name**, **Abbreviation**, **Clinician ID**, or **Symbol only**.

Require clinician ID to save readings

Make entering a clinician ID a prerequisite for saving measurements. If they fail to enter identification, the monitor prompts them when they try to save measurements. Clinicians can enter clinician identification on the Clinician tab.

Search by clinician ID

Enable the monitor to query the network for clinician information based on ID. The monitor

initiates the search when the clinician enters or scans the ID from the Clinician tab. Returned clinician information populates the Device Status area and fields on the Clinician tab.

Select **Require password** to require clinicians to enter their password, in addition to ID, on the Clinician tab. The monitor uses the ID and password combination to query the network for clinician information.

Clear clinician information on manual save

Specify that the monitor clears the selected clinician after a clinician manually saves measurements from the Home tab. Clinician information clears from the Clinician tab and the Device Status area.

5. Do one of the following:
 - To continue in the Advanced Settings, touch another tab.
 - To exit the Advanced Settings and return to the Home tab, touch **Exit**.

Specify clinical data settings

1. Access the Advanced Settings.
 - a. Touch the **Settings** tab.
 - b. Touch the **Advanced** tab.
 - c. Enter the **Advanced settings code**.
 - d. Touch **OK**.

The General tab appears.

2. Touch the **Data Management** tab.
3. Touch the **Clinical Data** tab.
4. Specify settings.

Setting

Automatically send on manual save

Action/Description

Select this option to specify that measurements are sent to the network when a clinician saves measurements on the Home tab.

Delete readings after successful send

Select this option to specify that measurements are deleted from the monitor after they are successfully sent to the network. Sent measurements do not appear in the Review tab.

Emulate Spot Vital Signs LXi

Select this option to specify that clinical data sent to the network appears as Spot Vital Signs LXi data at the network.

5. Do one of the following:
 - To continue in Advanced Settings, touch another tab.
 - To exit the Advanced Settings and return to the Home tab, touch **Exit**.

Network

View advanced monitor information

The Status tab shows the monitor's software version, MAC and IP addresses, network, server and access point information, session information, and more.

1. Access the Advanced Settings.
 - a. Touch the **Settings** tab.
 - b. Touch the **Advanced** tab.
 - c. Enter the **Advanced settings code**.
 - d. Touch **OK**.

The General tab appears.

2. Touch the **Network** tab.
3. Touch the **Status** tab.
4. View the information.
5. Do one of the following:
 - To continue in the Advanced Settings, touch another tab.
 - To exit the Advanced Settings and return to the Home tab, touch **Exit**.

Specify radio settings

This task is applicable only to monitors that have a radio installed.

1. Access the Advanced Settings.
 - a. Touch the **Settings** tab.
 - b. Touch the **Advanced** tab.
 - c. Enter the **Advanced settings code**.
 - d. Touch **OK**.

The General tab appears.

2. Touch the **Network** tab.
3. Touch the **Radio** tab.
4. Specify settings.

Setting

Enable radio

Enable radio network alarms

SSID

Radio band

Authentication type

Action/Description

Enable the radio for device communications. When disabled, the radio is not available.

Activate radio network alarms when an alarm condition occurs. When disabled, radio network alarms are not available.

Touch  and enter the service set identifier (SSID). Enter a maximum of 16 characters.

Select the radio band.

Select an authentication scheme. Then specify any additional settings that appear.

Method	Select a method. Then touch  and enter characters: Network key (64 characters), or Password (8 to 63 characters).
Security protocol	Select the security protocol.
EAP type	Select the EAP type.
Identity	Enter the EAP identity (maximum of 32 characters).
Password	Enter the EAP password (maximum of 32 characters).
Key number	Select the WEP key number.
Key	Enter the WEP key (10 characters for WEP 64, or 26 characters for WEP 128).
Configure radio	<p>Touch Configure radio to activate all new radio settings not selected previously.</p> <p>Touch OK in the confirmation popup telling you to power down the monitor.</p> <p>Touch the Settings tab. Touch the Device tab. Touch Power down.</p> <p>The radio will reboot.</p> <p>Note If you do not touch Configure radio, none of the changed radio settings will take effect.</p>

5. Do one of the following:
 - To continue in the Advanced Settings, touch another tab.
 - To exit the Advanced Settings and return to the Home tab, touch **Exit**.

Specify server settings

1. Access the Advanced Settings.
 - a. Touch the **Settings** tab.
 - b. Touch the **Advanced** tab.
 - c. Enter the **Advanced settings code**.
 - d. Touch **OK**.

The General tab appears.

2. Touch the **Network** tab.
3. Touch the **Server** tab.
4. Specify settings.



Setting

Obtain server IP information automatically

Action/Description

Enable the monitor to automatically obtain the server IP information via the network.

UDP broadcast port: Touch  and enter the port number that is used to automatically obtain server IP information. The range of entry is 0 to 65535.

IP address	Touch  and enter the IP address of the server that is used for patient data communication. The range of entry for each field is 0 to 255.
Port	Touch  and enter the port number associated with the server IP address. The range of entry is 0 to 65535.
Test	Touch Test to test the connection to the configured server.

5. Do one of the following:
 - To continue in the Advanced Settings, touch another tab.
 - To exit the Advanced Settings and return to the Home tab, touch **Exit**.

Service

For service-related advanced settings, see the service manual for this product.

Troubleshooting

This section presents tables of technical alarm and information messages, as well as problem descriptions that do not generate messages, to help you troubleshoot issues on the monitor.

Note Problem descriptions without messages appear at the end of this section.

When the monitor detects certain events, a message appears in the Device Status area at the top of the screen. Message types include the following:

- Information messages, which appear on a blue background.
- Low- and medium-priority alarms, which appear on an amber background.
- High-priority alarms, which appear on a red background.

Technical alarm messages are low priority unless noted in the Message column.

You can dismiss a message by touching the message on the screen, or, for some messages, you can wait for the message to time out.

To use these tables, locate the message that displays on the monitor in the left column of the table. The remainder of the row explains possible causes and suggests actions that can resolve the issue.

Note Instructions to "Call for service" in the following tables mean that you should contact qualified service personnel in your facility to investigate the issue.

NIBP messages

Message	Possible cause	Suggested action
NIBP air leak; check cuff and tubing connections.	The NIBP module has an air leak	Check the cuff and tubing connections. Clear the alarm and retry NIBP.
NIBP not functional. Call for service.	A module error occurred	Call for service.
Unable to determine NIBP; check connections; limit patient movement.	The NIBP module experienced a motion artifact	Check connections; limit patient movement. Clear the alarm and retry NIBP.
Unable to determine NIBP; check connections and tubing.	The NIBP tubing has a kink	Check the connections and tubing for kinks.

Message	Possible cause	Suggested action
		Clear the alarm and retry NIBP.
Incorrect NIBP cuff size; check patient type.	The cuff size is not correct	Check the patient type. Clear the alarm and retry NIBP.
Inflation too quick; check NIBP cuff and tubing connections.	NIBP inflation was too quick	Check the connections and tubing for kinks. Clear the alarm and retry NIBP.
Unable to determine NIBP; check inflation settings.	NIBP check inflation settings message	Check inflation settings and change as necessary. Clear the alarm and retry NIBP. Change the cuff inflation target (CIT).
Excessive patient movement.	NIBP measurements are not accurate because of artifact	Limit patient movement during blood pressure measurement.
Tube type does not match device configuration. (NIBP measurement is available)	The tube connected to the NIBP sensor does not match the monitor's configuration	Use the tube specified for the monitor.
Tube type does not match device configuration. (NIBP measurement is not available)	User is using a single-lumen tube with the following Advanced settings: 1. Patient type is Pediatric or Adult 2. Tube type is 2 3. Algorithm is SureBP	Clear message. Modify settings or tube use to match patient type.

SpO2 and SpHb messages

Message	Possible cause	Suggested action
SpO2 not functional. Call for service.	A module error has occurred	Try a new cable/sensor pair. Call for service.
Searching for pulse signal. (High-priority alarm)	The SpO2 sensor is not attached to the patient's finger	Touch the alarm icon or the SpO2 frame to dismiss the alarm. Set SpO2 alarm limits to OFF. Reattach the SpO2 sensor to the patient's finger.
Attach SpO2 sensor to monitor.	The sensor was not detected	Check the sensor connection. Replace the SpO2 sensor.

Message	Possible cause	Suggested action
Replace the SpO2 sensor.	The SpO2 sensor is faulty or expired	Replace the SpO2 sensor.
	No SpO2 sensor is connected	Connect an SpO2 sensor.
	The cable is faulty or expired	Replace the cable.
Replace the SpO2 cable.	The cable is faulty or expired	Replace the cable.
Low SpO2 signal quality. Check sensor.	Poor sensor placement on the patient	Remove the sensor from the patient and reapply.
Low SpHb signal quality. Check sensor.	Poor sensor placement on the patient	Remove the sensor from the patient and reapply.
Low perfusion. Check sensor.	Poor sensor placement on the patient	Remove the sensor from the patient and reapply.
SpO2 mode only. Check sensor or cable.	The sensor is operating as an SpO2-only sensor because it failed to calibrate properly	Reattach the cable to the monitor.
		Remove the sensor from the patient and reapply.
SpO2 sensor expires in....	The SpO2 sensor will expire soon	Replace the SpO2 sensor.

Temperature messages

Message	Possible cause	Suggested action
Connect temperature probe.	No probe is connected	Connect a temperature probe and retry.
	The probe is faulty	Replace the temperature probe.
	The temperature module returned a connect probe message	Connect a temperature probe and retry. If a probe is already connected, replace the probe.
Insert correct color-coded probe well.	The probe well is missing	Insert a temperature probe well.
Replace temperature probe.	The probe is faulty	Replace the temperature probe.
Temperature not functional. Call for service.	A module error occurred	Call for service.
Temperature time limit exceeded.	The 10-minute timeout for temperature measurement has occurred	Remove the probe from the measurement site.
Tissue contact lost	The probe has lost contact with the patient's tissue	Reposition the probe to restore proper contact with the patient's tissue.

Message	Possible cause	Suggested action
Retry temperature measurement. Note This message often accompanies other temperature messages.	A probe heater or data error occurred <hr/> User settings require adjustment	Retry the temperature measurement. If the problem persists, replace the probe. <hr/> Adjust the user settings and retry.

Weight scale messages

Message	Possible cause	Suggested action
Weight scale not functional. Call for service.	The weight scale is not operating properly.	Call for service.

Patient data management messages

Message	Possible cause	Suggested action
Maximum number of patient records saved. Oldest record overwritten.	The maximum number of patient records in the monitor's memory has been exceeded	On the Review tab, delete old records to prevent the alarm from appearing when new records are saved.
Unable to access patient information.	An error occurred when reading the patient list or patient record during startup	Power down and restart the monitor. If the error persists, call for service.
No data to save.	No patient data is available	Take or enter vital signs before saving.
Patient ID required to save data.	The configuration requires a patient ID to save data	Call for service.
Clinician ID required to save data.	The configuration requires a clinician ID to save data	Call for service.
Patient ID required to send data.	The configuration requires a patient ID to send data	Add a patient ID.
Patient list is full. Delete some patients to add more.	The maximum number of patients was exceeded	Delete a patient from the list to add a new patient.
Stop intervals to select new patient.	The monitor is set to take interval readings	Stop intervals before changing the patient.
No connection for send.	No connectivity is available to support sending data manually or automatically sending data on manual save	Call for service.
Unable to retrieve list.	The monitor is unable to retrieve a patient list from the network	Call for service.

Message	Possible cause	Suggested action
Unable to identify clinician.	The clinician ID or password is incorrect	Confirm the clinician ID and password (if applicable), and retry.

Radio messages

Message	Possible cause	Suggested action
Radio not functional. Call for service.	A hardware failure occurred (not currently used)	Call for service.
	The radio has the wrong software	
	The radio is not connected	
Radio error. Power down and restart.	The monitor and the radio failed to establish communication with each other	Power down and restart. If problem persists, call for service.
Unable to establish network communications. Radio out of network range.	The radio is no longer communicating with the access point	Call for service.
Unable to establish network communications. Call for service.	Unable to get an IP address from the DHCP server	Call for service.
Communications module did not power on properly. Power down the device. (High-priority alarm)	Communication failure.	Call for service.

Ethernet messages

Message	Possible cause	Suggested action
Network not found; check network cable connection.	A network cable is unplugged	Check the network cable connection. If problem persists, call for service.
	A network connection is broken elsewhere	

USB messages

Message	Possible cause	Suggested action
USB Communication failure. Call for service.	An internal or external device is connected but failed enumeration	Call for service.
External device not licensed for use.	A license for an external device (e.g., barcode scanner) has not been activated	Disconnect the unlicensed device.
External device not recognized.	An unrecognized external device is connected	Disconnect the unrecognized device.

Message	Possible cause	Suggested action
Incompatible Welch Allyn device.	A communication protocol failure has occurred	Call for service.
USB accessory disconnected.	The USB cable between an external device and the monitor is disconnected	Confirm that the USB cable is connected to the device and the monitor.

System messages

Message	Possible cause	Suggested action
Set date and time.	The date or time is not set	Set the date and time.
	The date or time is not set properly	Reset the date or time.
Ambient temperature outside operating range. Retry measurement.	The ambient temperature is out of range	Operate the monitor within the specified temperature range. Retry patient temperature measurement. If the message persists, move the patient and the monitor to a cooler location.
Device shutdown is not available at this time.	Device cannot perform an immediate shutdown	Touch OK , wait, and retry.
Advanced settings unavailable	Sensors are taking measurements	Stop continuous measurements.
	A physiological alarm condition is active	Respond to or reset the alarm.
	Spot Check measurements have not been saved	Save the measurements.
Unable to load language.	Chinese did not load	Power down and restart the monitor.
Unexpected restart occurred. Call for service.	A system error caused the monitor to restart. Call for service.	

Battery power manager messages

Message	Possible cause	Suggested action
Low battery 5 minutes or less remaining. (High-priority alarm)	Battery power is extremely low	Connect the monitor to AC power. (If not connected to AC power, the monitor powers down when AC power is depleted.)
Low battery 30 minutes or less remaining.	Battery power is low	Touch the alarm icon to dismiss or connect the monitor to AC power.

Message	Possible cause	Suggested action
Powering down. Call for service.	Power manager or battery faults have occurred	Call for service.
Battery is absent or faulty.	There is no battery in the monitor	Insert a battery.
	The battery is faulty	Replace the battery.
Device is operating in battery mode.	The AC power cord has been disconnected	Touch OK to dismiss or connect the monitor to AC power.

Configuration Manager messages

Message	Possible cause	Suggested action
Unable to load configuration; using factory defaults.	A configuration load error occurred	Call for service.
Functional error. Call for service.	A critical configuration load error occurred	Call for service.
No connection for send.	The monitor is not configured to the network	Call for service.

Printer messages

Message	Possible cause	Suggested action
Low battery; plug into outlet.	The monitor's battery voltage is too low to support printing	Connect the monitor to AC power.
Printer door is open; close to continue	The printer door is open	Close the printer door.
Out of paper.	The paper is not properly loaded	Align the paper with the print head. If the problem persists, call for service.
	The paper sensor does not detect paper	Replace the paper. If the problem persists, call for service.
Printer too hot; wait to retry.	The print head overheated	Wait for the print head to cool down and retry. If the problem persists, call for service.
Printer not functional. Call for service.	The printer motor is broken	Call for service.
	The detection switch malfunctioned	
	A hardware failure occurred in the power supply	
	The printer does not identify itself correctly	

Message	Possible cause	Suggested action
	The printer cannot communicate with the monitor	
	No printer; wrong printer	
External device not recognized.	An external printer is plugged into a USB port	Unplug the external printer.
Printing records: Note The number of records requested appears in the message and counts down during printing.	The monitor is printing the records selected on the Review tab	Acknowledge the number of records printing or touch Cancel to interrupt printing.
Printing report; please wait.	The printer needs more time to complete a print job when the Automatic print on interval control has been enabled	Wait for the print job to print completely.

Problems and solutions

The problems addressed in this table do not generate alarm or information messages on the monitor.

Problem	Possible cause	Suggested action
No SpHb value is displayed	An SpO2-only cable is connected to the monitor	Replace the SpO2-only cable with an SpO2/SpHb (Masimo Rainbow) cable.
	The SpHb cable has expired	Replace the SpHb cable.
	Note A technical alarm appears.	
	Poor sensor placement on the patient	Remove the sensor from the patient and reapply.
	The monitor may have the SpHb license, but the SpO2 module does not	Contact Welch Allyn to verify that the SpO2 module contains the SpHb license.
No weight measurement is transferred from the scale to the monitor	The scale is not connected	Inspect the USB cables from the device to the adapter to the scale to ensure that they are connected properly.
	The scale setting is incorrect	Ensure that the scale settings are enabled for transfer.

Appendix

Approved accessories

The following tables list approved monitor accessories and documentation. For information about options, upgrades, and licenses, refer to the service manual.

FlexiPort cuffs (Latex-free)

Part Number	Model	Description
Reuse-08	Reusable	Cuff, reuse, SM CHILD, 2-tube
Reuse-09	Reusable	Cuff, reuse, CHILD, 2-tube
Reuse-10	Reusable	Cuff, reuse, SM AD, 2-tube
Reuse-11	Reusable	Cuff, reuse, ADULT, 2-tube
Reuse-11L	Reusable	Cuff, reuse, AD LONG, 2-tube
Reuse-12	Reusable	Cuff, reuse, LG AD, 2-tube
Reuse-12L	Reusable	Cuff, reuse, LG AD LONG, 2-tube
Reuse-13	Reusable	Cuff, reuse, THIGH, 2-tube
Soft-08	Disposable	Cuff, soft, SM CHILD, 2-tube (box of 20)
Soft-09	Disposable	Cuff, soft, CHILD, 2-tube (box of 20)
Soft-10	Disposable	Cuff, soft, SM AD, 2-tube (box of 20)
Soft-11	Disposable	Cuff, soft, ADULT, 2-tube (box of 20)
Soft-11L	Disposable	Cuff, soft, AD LONG, 2-tube (box of 20)
Soft-12	Disposable	Cuff, soft, LG AD, 2-tube (box of 20)
Soft-12L	Disposable	Cuff, soft, LG AD LONG, 2-tube (box of 20)
Soft-13	Disposable	Cuff, soft, THIGH, 2-tube (box of 20)
5082-101-1	Disposable	Neo-1 disposable cuff, male luer connector (box of 10 cuffs)

Part Number	Model	Description
5082-102-1	Disposable	Neo-2 disposable cuff, male luer connector (box of 10 cuffs)
5082-103-1	Disposable	Neo-3 disposable cuff, male luer connector (box of 10 cuffs)
5082-104-1	Disposable	Neo-4 disposable cuff, male luer connector (box of 10 cuffs)
5082-105-1	Disposable	Neo-5 disposable cuff, male luer connector (box of 10 cuffs)
008-0851-00	Disposable	Neonatal Cuff Kit, (1 each neo #1 — 5, reusable infant cuff, NIBP hose)

Blood pressure accessories (Latex-free)

Part Number	Model	Description
4500-30	SureBP	Double tube blood pressure hose (5 ft)
4500-31	SureBP	Double tube blood pressure hose (10 ft)
4500-32	SureBP	Double tube blood pressure hose (8 ft)
6000-30	BP	Single tube blood pressure hose (5 ft)
6000-31	BP	Single tube blood pressure hose (10 ft)
6000-33	BP	Neonatal blood pressure hose (10 ft)
5200-08		Calibration "T" connector

Masimo pulse oximetry (for use with devices with SpO2)

Part Number	Model	Description
LNCS-DCI	LNCS	Reusable finger sensor - Adult
LNCS-DCIP	LNCS	Reusable finger sensor - Pediatric
LNCS-ADTX	LNCS	Disposable adhesive finger sensor - Adult (20 per case)
LNCS-PDTX	LNCS	Disposable adhesive finger sensor - Pediatric (20 per case)
RED LNC-10	LNCS	10-foot cable with sensor connector
LNCS-YI	LNCS	Multisite reusable sensor (1 sensor, 6 adhesive wraps)
LNCS-TC-I	LNCS	Reusable ear sensor
LNCS-Neo-L-3	LNCS	Disposable adhesive finger sensor - Neonate/Adult (20 per case)
Neo-Wrap-RP	LNCS	Replacement wrap for neonatal adhesives (100 per case)

Part Number	Model	Description
LNCS-Inf-3	LNCS	Disposable adhesive finger sensor - Infant (20 per case)
Inf-Wrap-RP	LNCS	Replacement wrap for infant adhesives (100 per case)
YI-AD	LNCS	Multisite adhesive wrap adult/pediatric/neonatal for YI sensor (100 per case)
YI-FM	LNCS	Multisite foam wrap adult/pediatric/neonatal for YI sensor (12 per case)

Masimo Rainbow SET (for use with devices with SpO2 and SpHb)

Part Number	Model	Description
104220	Rainbow	Adult reusable sensor and 3-foot cable
104360	Rainbow	ReSposable R2-25 sample pack
104149	Rainbow	Extension cable, 20 pin, 12 feet

Nellcor pulse oximetry

Part Number	Model	Description
DS-100A	OxiMax	Durasensor adult oxygen transducer
DOC-10	OxiMax	Extension cable (10 feet)
DOC-8	OxiMax	Extension cable (8 feet)
DOC-4	OxiMax	Extension cable (4 feet)
D-YS	OxiMax	Dura-Y oxygen transducer (1 sensor, 40 wraps)
D-YSE	OxiMax	Ear clip (use with Dura-Y sensor)
D-YSPD	OxiMax	PediCheck pediatric spot check (use with Dura-Y sensor)
MAX-AI	OxiMax	OxiMax adult sensor (single use, case of 24)
MAX-PI	OxiMax	OxiMax pediatric sensor (single use, case of 24)
MAX-II	OxiMax	OxiMax infant sensor (single use, case of 24)
OXI-A/N	OxiMax	Oxiband adult/neonatal transducer (1 sensor, 50 wraps)
OXI-P/I	OxiMax	Oxiband pediatric/infant transducer (1 sensor, 50 wraps)

SureTemp Plus thermometry

Part Number	Description
02895-000	Oral probe and well kit (9ft., 2.7M)
02895-100	Rectal probe and well kit (9ft., 2.7M)
02894-0000	Oral probe well (blue)
02894-1000	Rectal probe well (red)
05031-101	Disposable probe covers (1,000 covers, packaged 25/box)
05031-110	Disposable probe covers (10,000 covers, packaged 25/box)
06138-000	Temperature calibration key

Braun ThermoScan PRO 4000 thermometer and accessory dock

Part Number	Description
04000-900	Dock with thermometer
36000	Dock without thermometer
86100	Wall mount kit
86200	Mobile stand kit
53020-0000	Rechargeable battery pack for the thermometer

Mounting options

Part Number	Description
4800-60	Accessory Cable Management (ACM) — organized mobile stand with basket
4700-60	Economy mobile stand with basket
4701-62	Wall mount with basket
008-0834-01	GCX wall mount with channel

Weight scales and connectivity kits

For a list of approved weight scales and connectivity kits, go to www.welchallyn.com.

Miscellaneous items

Part Number	Description
BATT69	Lithium-ion battery 6 Cell
BATT99	Lithium-ion battery 9 Cell — Extended Life
6000-100H	Carrying case, hard sided
6000-100S	Carrying case, soft sided
PWCD-B	Line cord B, North America
PWCD-2	Line cord 2, Europe
PWCD-A	Line cord A, Denmark
PWCD-5	Line cord 5, Switzerland
PWCD-4	Line cord 4, United Kingdom
PWCD-6	Line cord 6, Australia/New Zealand
PWCD-66	Line cord 6, Australia/New Zealand —Orange
PWCD-C	Line cord C, China
PWCD-G	Line cord G, Argentina
PWCD-7	Line cord 7, South Africa
PWCD-N	Line cord N, India
PWCD-3	Line cord 3, Israel
PWCD-Y	Line cord Y, Italy
PWCD-K	Line cord K, South Korea
PWCD-T	Line cord T, Taiwan
PWCD-P	Line cord P, Thailand
PWCD-Z	Line cord Z, Brazil
6000-NC	Nurse Call Cable
6000-915	2D Barcode scanner kit — scanner, mounting bracket, hardware
6000-915HS	HS1-M 2D Barcode scanner with coiled USB
6000-910	Mounting Arm for HS1-M Barcode Scanner (use with Economy mobile stand with basket only)
4500-925	USB cable for wired connectivity

Part Number	Description
660-0321-00	Patch cable, 50'
660-0320-00	Patch cable, 100'
660-0138-00	Patch cable, 5'
715270	Box set — packaging — empty
6000-50	USB memory stick

Service

Part Number	Description
S1-6000	Comprehensive partnership program, 1 year
S1-6000-2	Comprehensive partnership program, 2 years
S2-6000	Biomed partnership program, 1 year
S2-6000-2	Biomed partnership program, 2 years

Literature/Documentation

Part Number	Description
103730	CD, Directions for Use, Service Manual, Multi-lingual
4600-90E	Blood Pressure Accuracy and Variability Card, English
6000-150E	In-service CD
Directions for Use	
103501	Directions for Use, Printed Copy, English
103604	Directions for Use, Printed Copy, French
103605	Directions for Use, Printed Copy, German
103606	Directions for Use, Printed Copy, Dutch
103607	Directions for Use, Printed Copy, Portuguese
103608	Directions for Use, Printed Copy, Spanish
103609	Directions for Use, Printed Copy, Simplified Chinese
103650	Directions for Use, Printed Copy, Swedish
103651	Directions for Use, Printed Copy, Italian

Part Number	Description
103652	Directions for Use, Printed Copy, Danish
103653	Directions for Use, Printed Copy, Polish
103654	Directions for Use, Printed Copy, Finnish
103655	Directions for Use, Printed Copy, Greek
103656	Directions for Use, Printed Copy, Norwegian
104187	Directions for Use, Printed Copy, Traditional Chinese
104188	Directions for Use, Printed Copy, Korean
Quick Reference Card	
103502	Quick Reference Card, English
103658	Quick Reference Card, French
103659	Quick Reference Card, German
103660	Quick Reference Card, Dutch
103661	Quick Reference Card, Portuguese
103662	Quick Reference Card, Spanish
103663	Quick Reference Card, Simplified Chinese
103664	Quick Reference Card, Swedish
103665	Quick Reference Card, Italian
103666	Quick Reference Card, Danish
103667	Quick Reference Card, Polish
103668	Quick Reference Card, Finnish
103669	Quick Reference Card, Greek
103670	Quick Reference Card, Norwegian
104330	Quick Reference Card, Traditional Chinese
104331	Quick Reference Card, Korean
Startup Guide	
103503	Startup Guide
Service Manual (English only)	
103500	Service Manual, English

Part Number	Description
Directions for Use, ACM Mobile Stand	
4800-60	Directions for Use, Accessory Cable Management (ACM) Mobile Stand

Warranty

Welch Allyn warrants the product to be free of defects in material and workmanship and to perform in accordance with manufacturer's specifications for the period of two years from the date of purchase from Welch Allyn or its authorized distributors or agents.

The warranty period shall start on the date of purchase. The date of purchase is: 1) the invoiced ship date if the device was purchased directly from Welch Allyn, 2) the date specified during product registration, 3) the date of purchase of the product from a Welch Allyn authorized distributor as documented from a receipt from said distributor.

This warranty does not cover damage caused by: 1) handling during shipping, 2) use or maintenance contrary to labeled instructions, 3) alteration or repair by anyone not authorized by Welch Allyn, and 4) accidents.

The product warranty is also subject to the following terms and limitations: Accessories are not covered by the warranty. Refer to the directions for use provided with individual accessories for warranty information.

Shipping cost to return a device to a Welch Allyn Service center is not included.

A service notification number must be obtained from Welch Allyn prior to returning any products or accessories to Welch Allyn's designated service centers for repair. To obtain a service notification number, contact Welch Allyn Technical Support.

THIS WARRANTY IS IN LIEU OF ALL OTHER WARRANTIES, EXPRESS OR IMPLIED, INCLUDING BUT NOT LIMITED TO THE IMPLIED WARRANTIES OF MERCHANTABILITY AND FITNESS FOR A PARTICULAR PURPOSE. WELCH ALLYN'S OBLIGATION UNDER THIS WARRANTY IS LIMITED TO REPAIR OR REPLACEMENT OF PRODUCTS CONTAINING A DEFECT. WELCH ALLYN IS NOT RESPONSIBLE FOR ANY INDIRECT OR CONSEQUENTIAL DAMAGES RESULTING FROM A PRODUCT DEFECT COVERED BY THE WARRANTY.

